

bombas
IDEAL

SERIE **S**



50Hz

60Hz

UNE 166.002

BUREAU VERITAS
Certification



ISO 9001

BUREAU VERITAS
Certification



ISO 14001

BUREAU VERITAS
Certification



SUM 1078

Índice

Index



Electrobombas sumergibles Electric submersible pumps Electropompe immerge	TXI-SXT / TRITON / SD / SDX TXI-SXT / TRITON / SD / SDX TXI-SXT / TRITON / SD / SDX	3
Campos de trabajo Performance charts Champs de travail	50Hz	6
Campos de trabajo Performance charts Champs de travail	60Hz	7
Serie S 4"	50Hz	8
Serie STI - ST 6"	50Hz	14
Serie TXI 4"	50Hz	19
Serie SXT 6 - 8 - 10"	50Hz	23
Serie SD SDX 6 - 8 - 10 - 14 - 16"	50Hz	32
Serie S 4"	60Hz	50
Serie STI - ST 6"	60Hz	56
Serie TXI 4"	60Hz	59
Serie SXT 6 - 8 - 10"	60Hz	63
Serie SD SDX 6 - 8 - 10 - 16"	60Hz	72
Datos técnicos Technical data Donnes techniques		89

50Hz

60Hz



Certificación / Certification / Certification

UNE 166.002
BUREAU VERITAS
 Certification



ISO 14001
BUREAU VERITAS
 Certification



ISO 9001
BUREAU VERITAS
 Certification



Calidad y Servicio
 Son las dos constantes que mueven la empresa. Sintonizar con los deseos de los clientes y anticiparse a ellos nos permite gozar de su confianza, siendo esto el mejor valor de **Bombas Ideal**.



Quality and Service
 There are two constants that move our company; to know the customers wishes, and to anticipate them. This allows us to enjoy their trust. It is the best value of **Bombas Ideal**.



Qualité et Service
 La deux constantes qui poussent l'entreprise. Connaitre les souhaits des clients et s'anticiper à eux. Nous permet de jouir de leurs confiance. Cela est la meilleur value de: **Bombas Ideal**.



Todo inoxidable
All Made of Stainless Steel
Tout en Inoxydable



Electrobombas sumergibles en acero inox.
Submersible electric pumps made of stainless steel
Électropompes submersibles en acier inox.

TXI-SXT

Aplicaciones

Las bombas TXI, SXT son apropiadas para el suministro de agua a viviendas y poblaciones, granjas, industria o agricultura, fuentes y otras aplicaciones. Su construcción extremadamente robusta y enteramente en acero inoxidable, permite la utilización en las aplicaciones más exigentes.

Estas bombas están fabricadas en acero inoxidable AISI 304.

Construcción bomba

El objetivo principal durante el diseño de las series TXI y SXT ha sido obtener unas bombas de alto rendimiento y de gran calidad y robustez para resistir la corrosión y abrasión, obteniendo una duración excepcional. Estas bombas están enteramente fabricadas en acero inoxidable. Todas las piezas están sobredimensionadas ofreciendo gran rigidez y resistencia al desgaste. Todas las partes son controladas y el resultado es sorprendente: un conjunto perfecto combinando solidez, seguridad y resistencia.

Bajo demanda

Se puede suministrar con variador de velocidad Variache y Varivip, según potencia y tensión.

Applications

TXI and SXT pumps are suitable for water supply to homes and villages, farms, industry and agriculture, sources and others applications. Its rugged construction and entirely in stainless steel, allows use in demanding applications. These pumps are manufactured in AISI 304 stainless steel.

Pump construction

The main objective in the design of TXI and SXT series has been to obtain high performance pumps and high-quality and robustness to resist corrosion and abrasion, giving an exceptional durability. These pumps are entirely manufactured in stainless steel. All the pieces are oversized offering high stiffness and wear resistance. All parts are checked and the result is amazing: a perfect set combining robustness, security and resistance.

On request

Can be supplied with Variache and Varivip frequency inverter, according to power and voltage.

Applications

Les pompes TXI et SXT sont appropriées pour l'approvisionnement en eau des logements et des populations, fermes, industrie et de l'agriculture, sources et d'autres applications. Sa construction extrêmement robuste et entièrement en acier inoxydable, permet l'utilisation dans les applications les plus exigeantes.

Construction de la pompe

L'objectif principal au cours de la conception des séries TXI et SXT a été d'obtenir les pompes à haut rendement et de grande qualité et de robustesse pour résister à la corrosion et d'abrasion, réalisant une durée exceptionnelle.

Sur demande

On peut fournir avec variateur de vitesse Variache et Varivip, selon puissance et de tension.

Electrobombas sumergibles
Electric submersible pumps
Electropompe immerge

TRITON



Cuerpo impulsión Inox.
St. st discharge case
Corps de refoulement inox.

Cuerpo aspiración Inox. con colador incorporado
St. st. suction case with incorporated strainer
Corps d'aspiration avec filtre corpore

Aplicaciones

Electrobombas sumergidas multicelulares. Turbinas radiales o semiaxiales y difusores en noryl, cojinetes en cerámica-goma, en los motores con baño de aceite, carcasa exterior y eje en acero inoxidable. Válvula de retención incorporada en el cuerpo de impulsión. Acoplamiento bomba a motor según norma NEMA.

Bomba tipo: Radial. Temperatura máxima líquido: 30°. Sentido rotación: Antihorario. Válvula de retención: Incorporada.

Materiales de serie

Impulsor: Noryl. Difusor: Noryl. Eje: Acero inox.. Camisa: Acero inox.

Bajo demanda

Se puede suministrar con variador de velocidad Variache y Varivip, según potencia y tensión.

Ventajas

No se precisa desmontar el colador para pasar el cable. Gran resistencia a la corrosión de toda la bomba.

Applications

Electric submersible multistage pumps with radial or semi-axial turbines, diffusers in noryl and bearings in ceramic-rubber. In motors with oil bath, outer casing and shaft in stainless steel. Check valve incorporated in the discharge casing. The pump/motor coupling according to NEMA standard.

Standard materials

Impellers: Noryl. Diffuser: Noryl. Shaft: Stainless steel. Shell: Stainless steel.

On request

Can be supplied with Variache and Varivip frequency inverter, according to power and voltage.

Advantages

Not necessary to remove the strainer to pass the cable. High resistance to corrosion of the entire pump.

Applications

Électropompes submergées multicellulaires avec turbines radiaux ou semiaxiales, diffuseurs en noryl et coussinets en céramique-caoutchouc. Dans les moteurs avec bain d'huile, boîtier extérieur et arbre en acier inoxydable. Clapet de retenue incorporée dans le corps de refoulement. L'accouplement pompe/moteur conforme à la norme NEMA.

Materiaux standard

Roue: Noryl. Diffuseur: Noryl. Arbre: Acier inoxydable. Chemise: Acier inoxidable.

Sur demande

On peut fournir avec variateur de vitesse Variache et Varivip, selon puissance et de tension.

Avantages

Ne précise démonter le crepine pour passer le câble. Grande résistance à la corrosion de toute la pompe.

Electrobomba sumergida
Electric submersible pumps
Electropompe immerge

SD-SDX

Descripción

Electrobombas sumergidas multicelulares con turbinas radiales o semiaxiales en hierro fundido GG-25 o bronce, cuerpos de bomba en hierro fundido GG-25 o bronce, eje en acero inoxidable guiado por cojinetes de goma. Acoplamiento bomba a motor según norma NEMA. Disponible versión SDX completamente en acero inoxidable, con diseño y espesores optimizados.

Description

Electro submersible multistage borehole pumps, with radial or semi-axial in cast iron or bronze impellers. Pump casings in cast iron or bronze, shaft in Stainless Steel with rubber bearings. Submersible motors are according to Nema standards. Available SDX range fully in St.St. with improved design and optimized thickness.

Denomination

Electropompes immergées multicellulaires avec roues radiales ou semi-axiales en fonte GG-25, ou bronze, corps de pompe en fonte GG-25, arbre en acier inoxydable avec des coussinets en caoutchouc. L'accouplement pompe-moteur conforme à la norme NEMA. Version SDX disponible entièrement en acier inoxydable avec le concept et l'épaisseur optimisée.

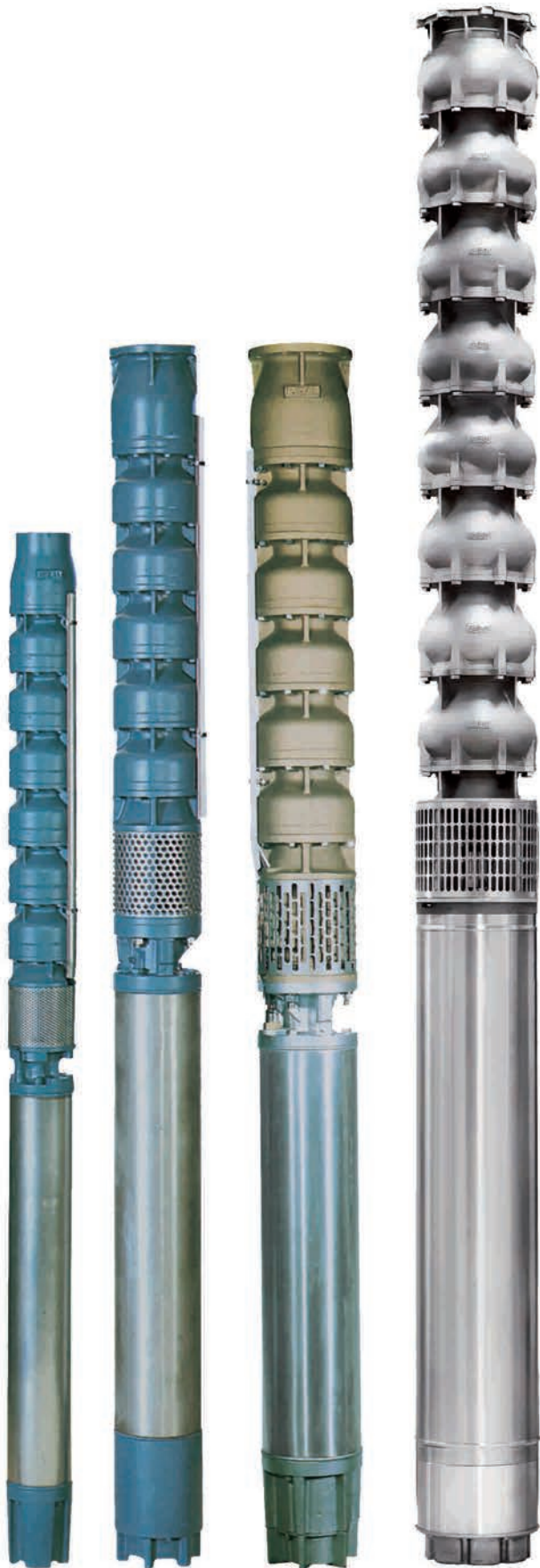

SD



SDX

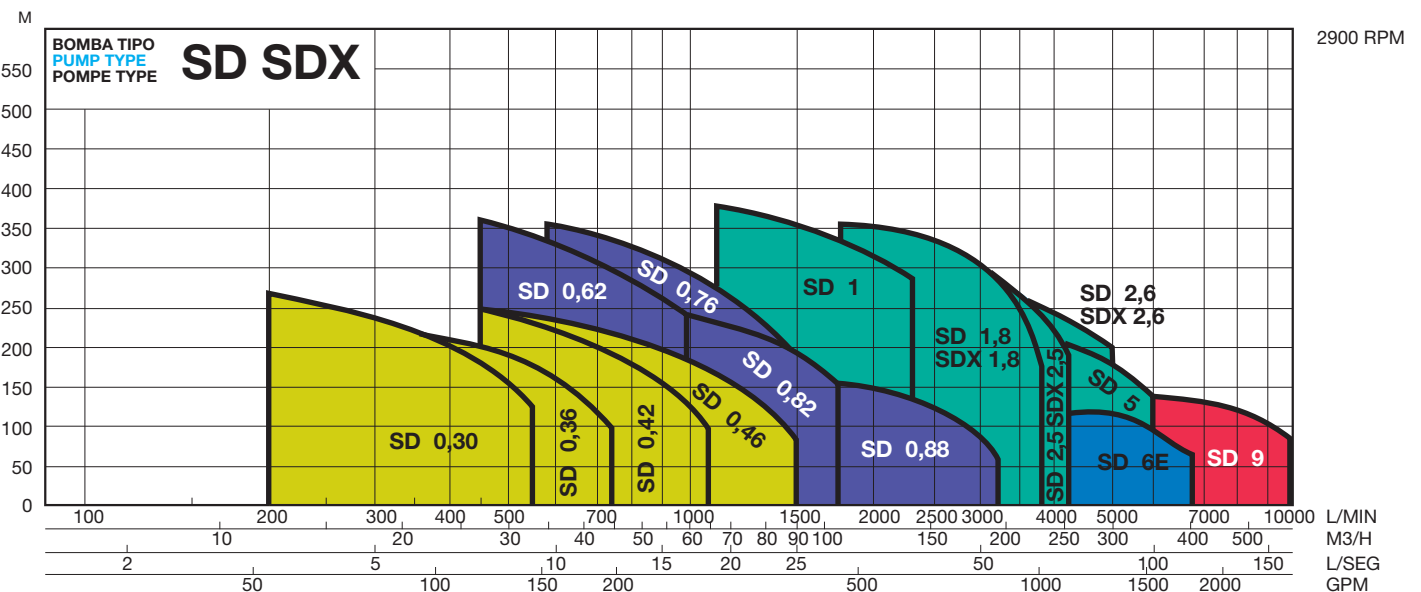
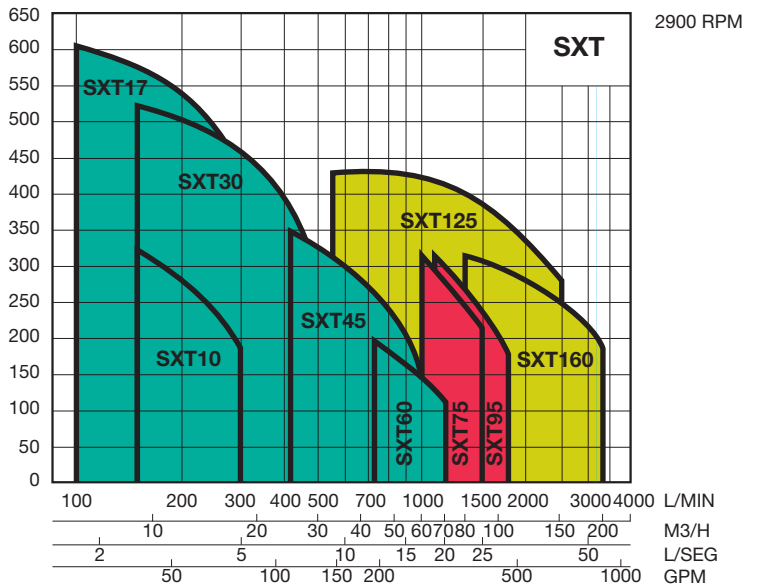
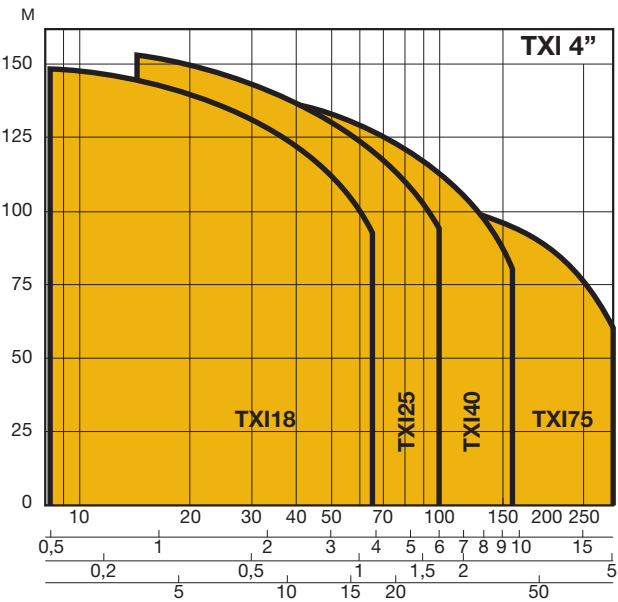
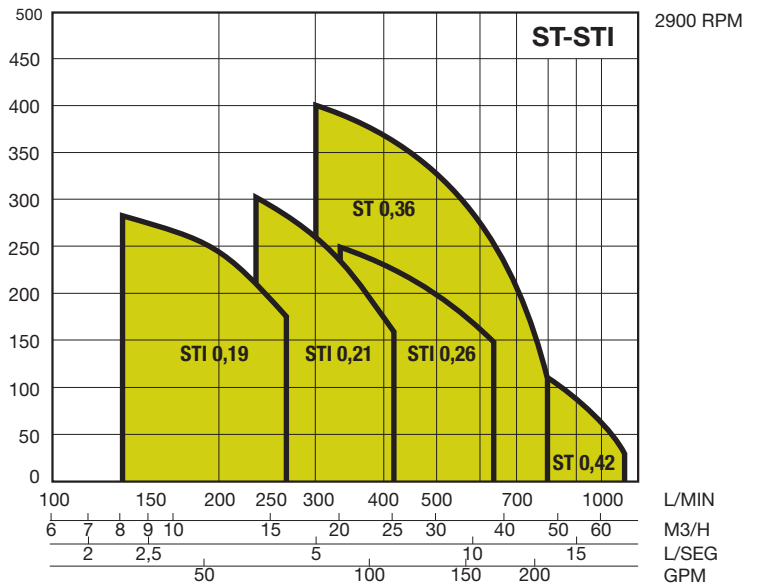
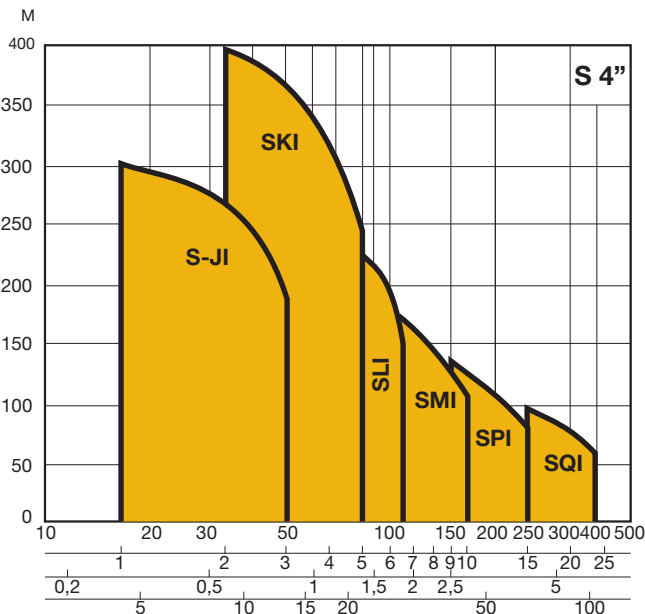

50HZ



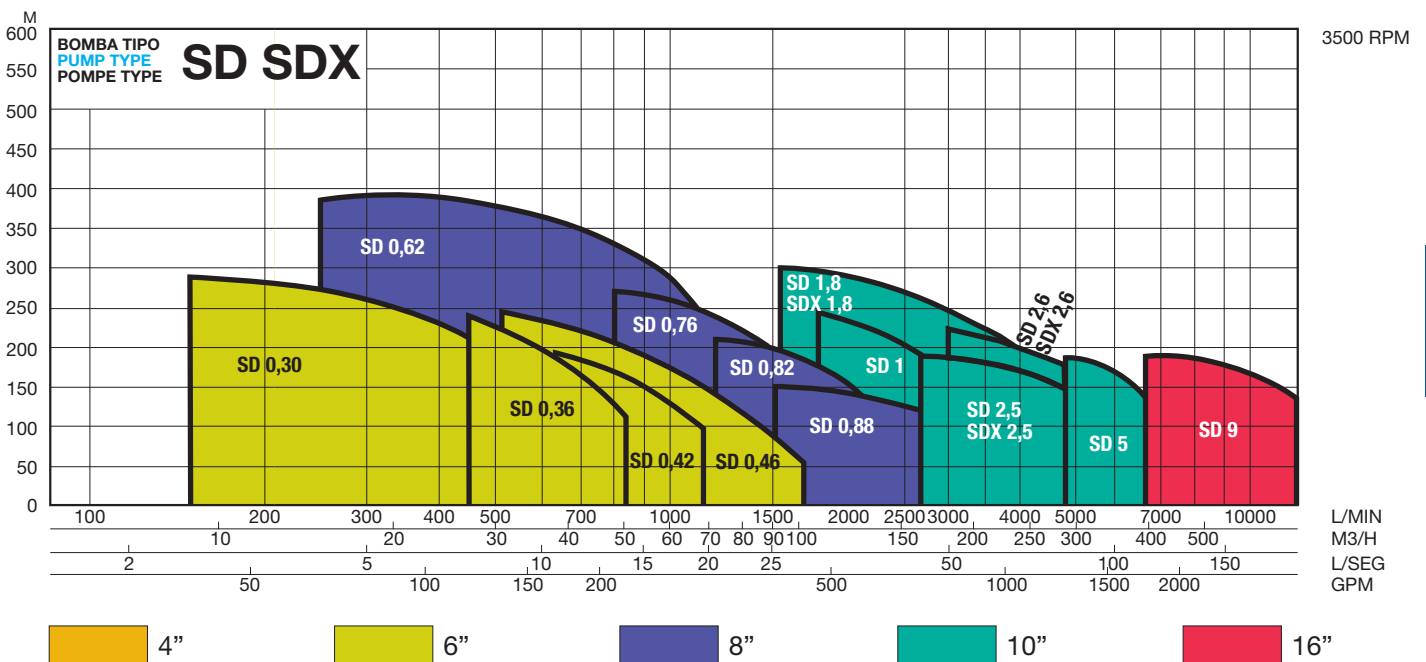
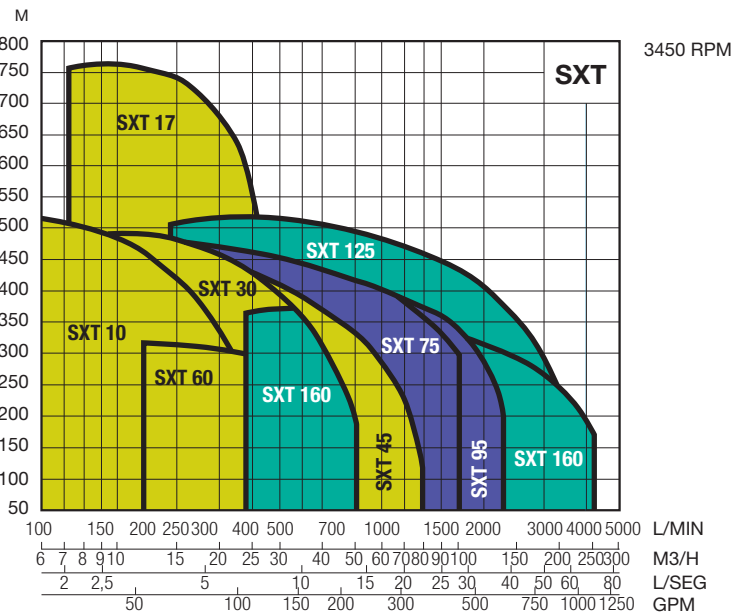
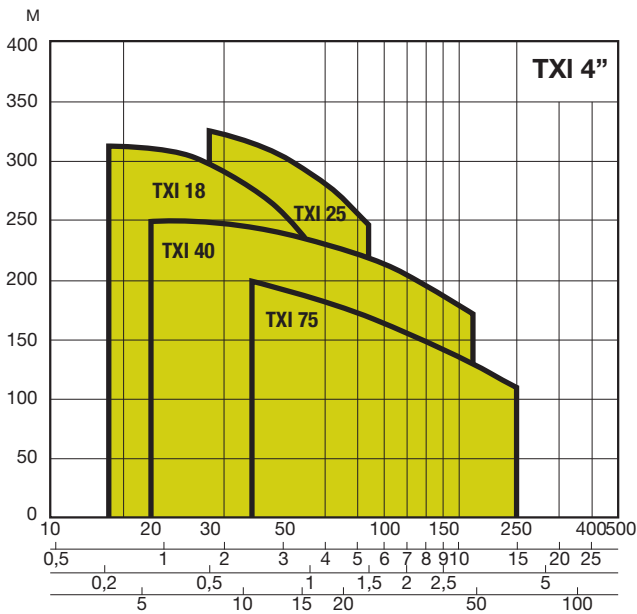
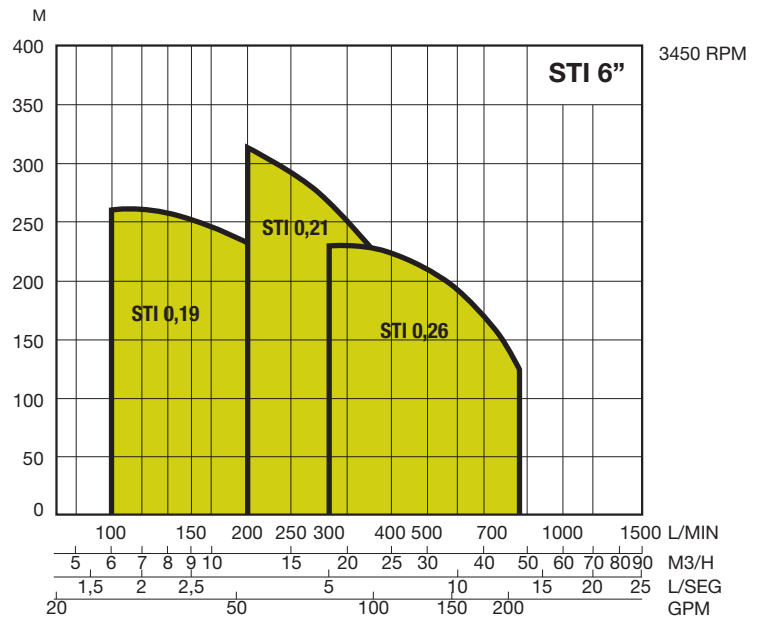
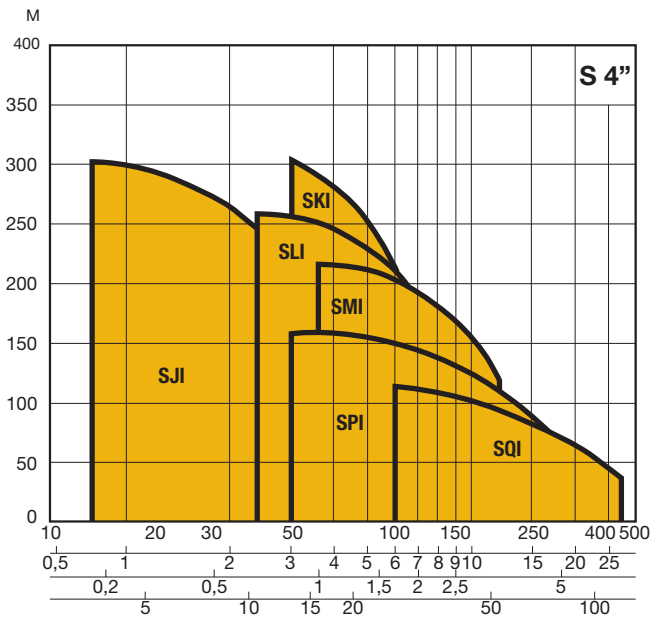

BOMBA TIPO: RADIAL
 TEMP. MAX. LIQUIDO: 30°
 MAX. ARENA: 200 gr/m³
 SENTIDO ROT.: ANTIHORARIO
 VALV. RET.: INCORPORADA

PUMP TYPE: RADIAL
 MAXI. TEMP. LIQUID: 30°
 SAND MAX.: 200 gr/m³
 ROTATION: C.C.W.
 CHECK VAL.: BUILT-IN

POMPE TYPE: RADIALE
 TEMP. MAX. LIQUIDE: 30°
 MAX. SABLE: 200 gr/m³
 SENS. ROT.: ANTIHORAIRE
 CLAPET RET.: INCORPORÉ

Tablas de selección / Selection charts / Tables de selection

Tipo Type	Motor - Moteur		l/min. m³/h	Caudal - Capacity - Debit							
	KW	HP		0	17	25	30	33	42	50	58
				0	1	1,5	1,8	2	2,5	3	3,5
SJI 6	0,37	0,5	m.c.a.	50	45	38	36	34	30	24	12
SJI 8	0,55	0,75		62	60	58	56	50	45	40	30
SJI 12	0,75	1		95	91	89	83	80	65	56	42
SJI 16	1,1	1,5		132	118	116	113	109	85	75	55
SJI 20	1,5	2		170	155	146	140	137	120	102	78
SJI 30	2,2	3		240	225	215	207	200	175	145	107
SJI 40	3	4		313	292	282	266	250	220	180	135
SJI 50	4	5,5		375	360	340	321	310	276	230	170

Dimensiones / Dimensions / Dimensions

Materiales tipo A
 Impulsor: Noryl
 Difusor: Noryl
 Eje: Acero inox.
 Camisa: Acero inox.

Material type A
 Impeller: Noryl
 Diffuser: Noryl
 Shaft: St. steel
 Shell: St. steel

Materiaux type A
 Roue: Noryl
 Diffuseur: Noryl
 Arbre: Acier inox.
 Chemise: Acier inox.

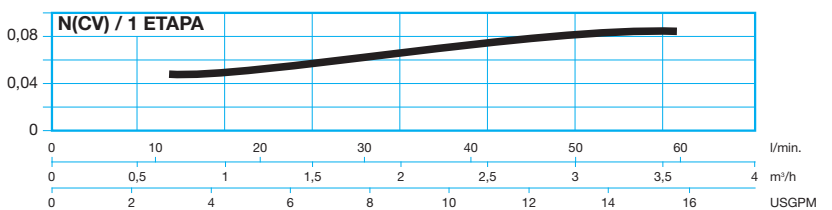
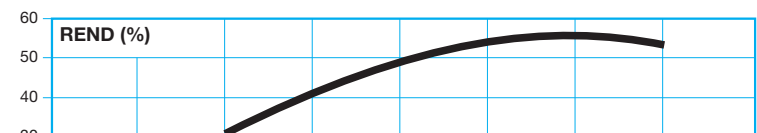
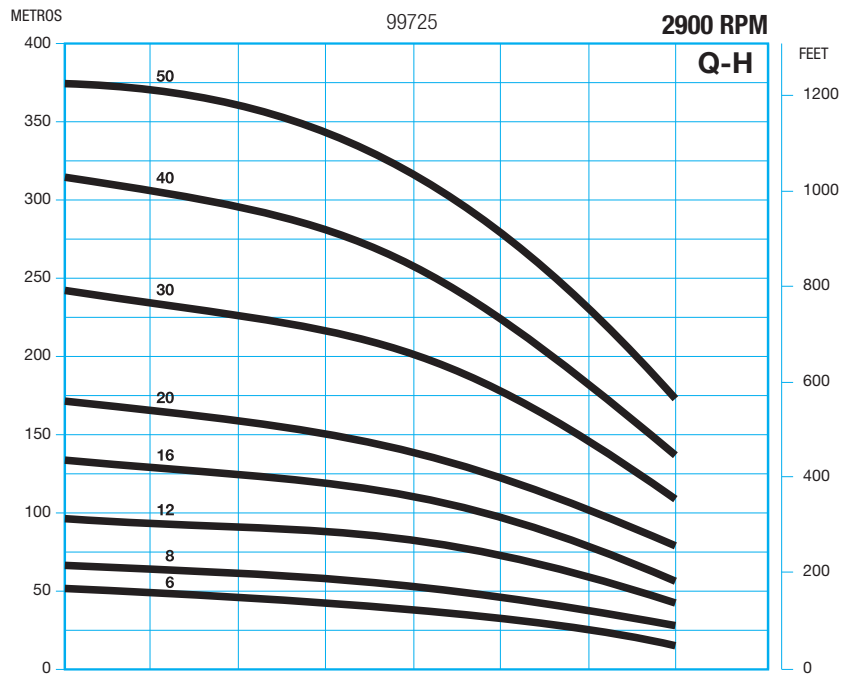
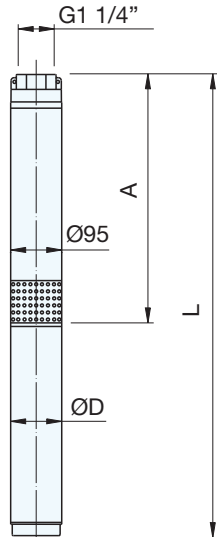

Tipo Type	Motor - Moteur		D mm	A mm	L mm	Peso Weight Poids (kg)
	KW	HP				
SJI 6	0,37	0,5	95	392	743	10,9
SJI 8	0,55	0,75	95	443	809	12,4
SJI 12	0,75	1	95	548	934	14,2
SJI 16	1,1	1,5	95	651	1057	15,9
SJI 20	1,5	2	95	755	1196	18,4
SJI 30	2,2	3	95	1062	1563	22,2
SJI 40	3	4	95	1323	1884	30,2
SJI 50	4	5,5	95	1583	2184	41,2

BOMBA TIPO: RADIAL
 TEMP. MAX. LIQUIDO: 30°
 MAX. ARENA: 200 gr/m³
 SENTIDO ROT.: ANTIHORARIO
 VALV. RET.: INCORPORADA

PUMP TYPE: RADIAL
 MAXI. TEMP. LIQUID: 30°
 SAND MAX.: 200 gr/m³
 ROTATION: C.C.W.
 CHECK VAL.: BUILT-IN

POMPE TYPE: RADIALE
 TEMP. MAX. LIQUIDE: 30°
 MAX. SABLE: 200 gr/m³
 SENS. ROT.: ANTIHORAIRE
 CLAPET RET.: INCORPORÉ

Tablas de selección / Selection charts / Tables de selection

Tipo Type	Motor - Moteur		l/min. m³/h	Caudal - Capacity - Debit							
	KW	HP		0	33	50	58	67	75	83	92
				0	2	3	3,5	4	4,5	5	5,5
SKI 6	0,55	0,75	m.c.a.	46	42	38	36	32	30	25	20
SKI 9	0,75	1		63	58	55	50	48	40	36	29
SKI 12	1,1	1,5		86	80	76	68	64	56	48	38
SKI 16	1,5	2		115	105	101	90	85	75	64	51
SKI 20	2,2	3		150	142	130	120	107	98	85	75
SKI 24	3	4		175	170	152	148	138	120	100	88
SKI 30	3	4		210	195	178	168	150	138	120	100
SKI 40	4	5,5		268	255	230	210	190	168	138	105
SKI 55	5,5	7,5		370	350	330	305	280	250	215	165
SKI 75	7,5	10		438	420	378	348	330	288	240	180

Dimensiones / Dimensions / Dimensions

Materiales tipo A
 Impulsor: Noryl
 Difusor: Noryl
 Eje: Acero inox.
 Camisa: Acero inox.

Material type A
 Impeller: Noryl
 Diffuser: Noryl
 Shaft: St. steel
 Shell: St. steel

Materiaux type A
 Roue: Noryl
 Diffuseur: Noryl
 Arbre: Acier inox.
 Chemise: Acier inox.

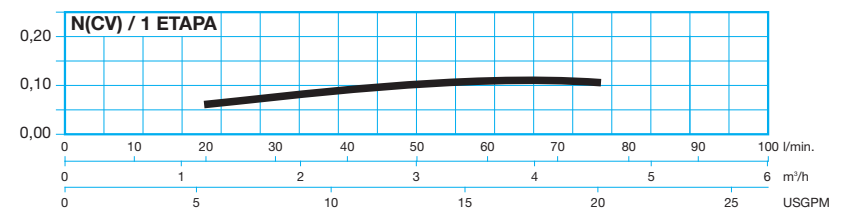
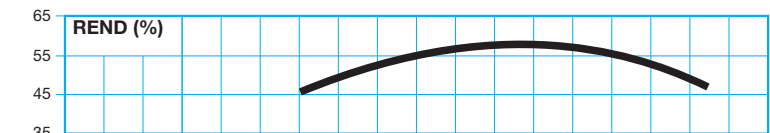
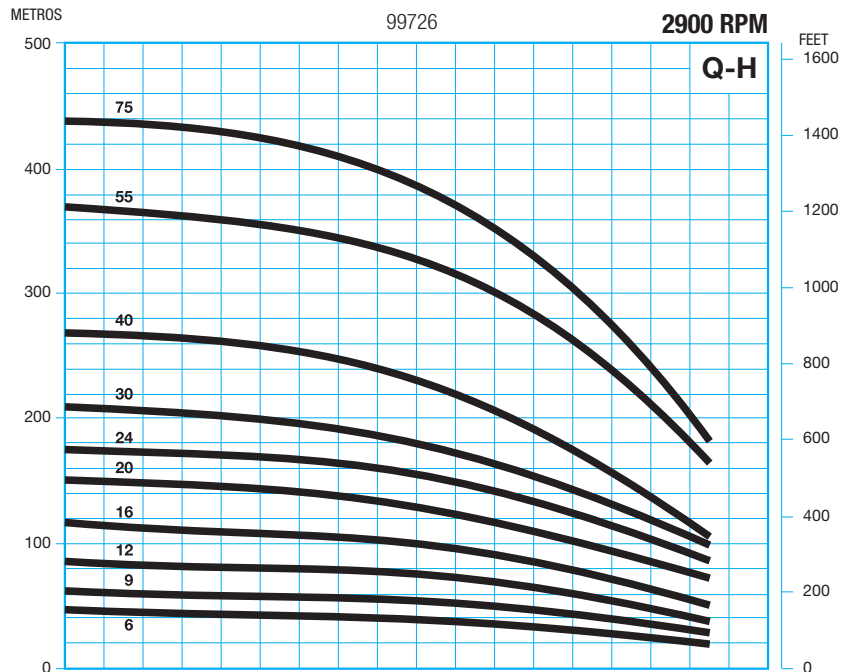
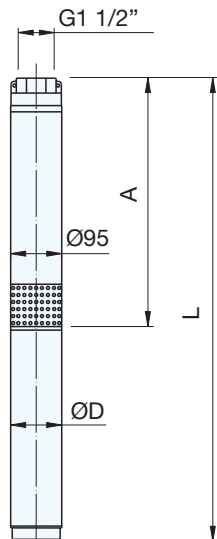

Tipo Type	Motor - Moteur		D mm	A mm	L mm	Peso Weight Poids (kg)
	KW	HP				
SKI 6	0,55	0,75	95	418	784	12,3
SKI 9	0,75	1	95	478	864	14,5
SKI 12	1,1	1,5	95	568	974	16,1
SKI 16	1,5	2	95	691	1132	18,4
SKI 20	2,2	3	95	843	1344	20,7
SKI 24	3	4	95	1010	1571	27,2
SKI 30	3	4	95	1128	1689	28,4
SKI 40	4	5,5	95	1405	2006	36
SKI 55	5,5	7,5	95	1845	2566	44,5
SKI 75	7,5	10	95	2171	3012	66,3

BOMBA TIPO: RADIAL
 TEMP. MAX. LIQUIDO: 30°
 MAX. ARENA: 200 gr/m³
 SENTIDO ROT.: ANTIHORARIO
 VALV. RET.: INCORPORADA

PUMP TYPE: RADIAL
 MAXI. TEMP. LIQUID: 30°
 SAND MAX.: 200 gr/m³
 ROTATION: C.C.W.
 CHECK VAL.: BUILT-IN

POMPE TYPE: RADIALE
 TEMP. MAX. LIQUIDE: 30°
 MAX. SABLE: 200 gr/m³
 SENS. ROT.: ANTIHORAIRE
 CLAPET RET.: INCORPORÉ

Tablas de selección / Selection charts / Tables de selection

Tipo Type	Motor - Moteur		l/min. m³/h	Caudal - Capacity - Debit							
	KW	HP		0	17	33	50	67	83	100	117
				0	1	2	3	4	5	6	7
SLI 6	0,75	1	m.c.a.	46	45	43	42	40	35	28	20
SLI 9	1,1	1,5		71	66	65	62	59	52	41	28
SLI 11	1,5	2		82	81	79	77	71	62	51	34
SLI 13	1,5	2		96	94	93	90	83	73	58	40
SLI 18	2,2	3		127	124	121	113	108	92	83	50
SLI 23	3	4		168	165	162	160	146	128	102	68
SLI 32	4	5,5		232	228	215	208	201	176	140	94
SLI 40	5,5	7,5		290	282	275	270	251	220	175	117
SLI 56	7,5	10		381	375	368	356	331	289	231	155

Dimensiones / Dimensions / Dimensions

Materiales tipo A
 Impulsor: Noryl
 Difusor: Noryl
 Eje: Acero inox.
 Camisa: Acero inox.

Material type A
 Impeller: Noryl
 Diffuser: Noryl
 Shaft: St. steel
 Shell: St. steel

Materiaux type A
 Roue: Noryl
 Diffuseur: Noryl
 Arbre: Acier inox.
 Chemise: Acier inox.

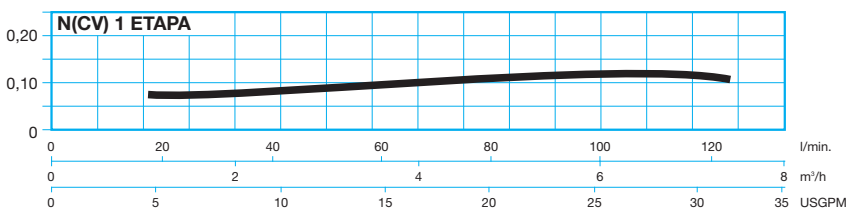
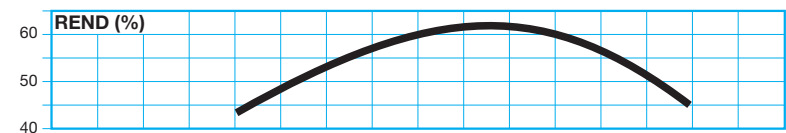
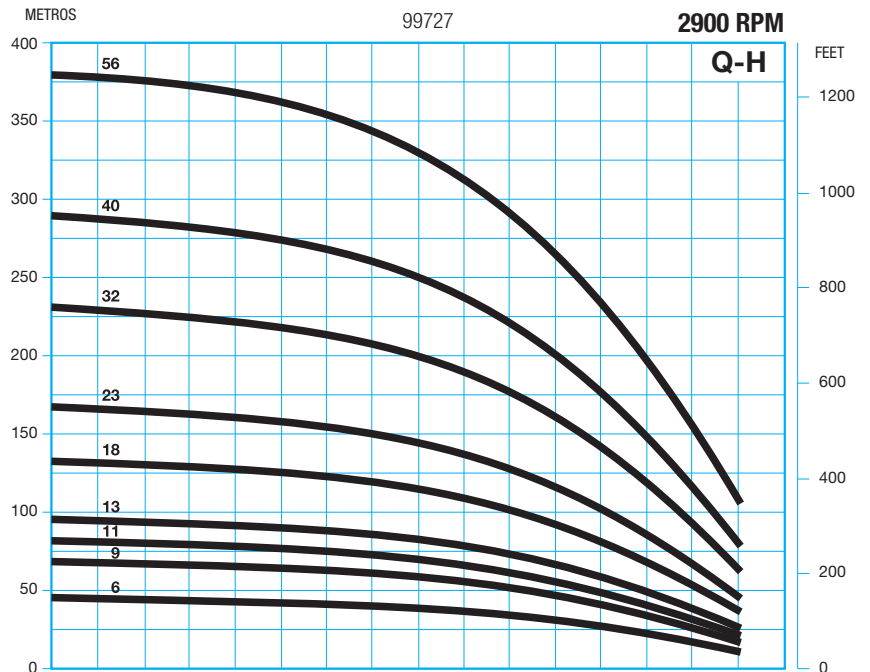
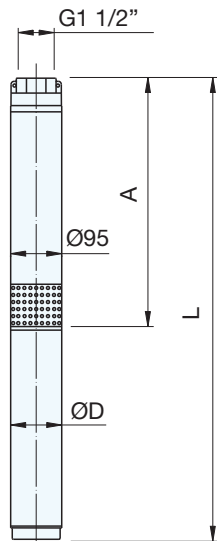

Tipo Type	Motor - Moteur		D mm	A mm	L mm	Peso Weight Poids (kg)
	KW	HP				
SLI 6	0,75	1	95	454	840	11,4
SLI 9	1,1	1,5	95	564	970	15,6
SLI 11	1,5	2	95	637	1078	17,5
SLI 13	1,5	2	95	710	1151	18,3
SLI 18	2,2	3	95	857	1358	21,4
SLI 23	3	4	95	1122	1683	28,2
SLI 32	4	5,5	95	1454	2055	36,4
SLI 40	5,5	7,5	95	1790	2511	45,5
SLI 56	7,5	10	95	2338	3179	64,5

BOMBA TIPO: RADIAL
 TEMP. MAX. LIQUIDO: 30°
 MAX. ARENA: 200 gr/m³
 SENTIDO ROT.: ANTIHORARIO
 VALV. RET.: INCORPORADA

PUMP TYPE: RADIAL
 MAXI. TEMP. LIQUID: 30°
 SAND MAX.: 200 gr/m³
 ROTATION: C.C.W.
 CHECK VAL.: BUILT-IN

POMPE TYPE: RADIALE
 TEMP. MAX. LIQUIDE: 30°
 MAX. SABLE: 200 gr/m³
 SENS. ROT.: ANTIHORAIRE
 CLAPET RET.: INCORPORÉ

Tablas de selección / Selection charts / Tables de selection

Tipo Type	Motor - Moteur		l/min. m ³ /h	Caudal - Capacity - Debit							
	KW	HP		0	33	67	100	117	133	150	167
				0	2	4	6	7	8	9	10
SMI 8	1,5	2	m.c.a.	56	54	52	44	40	35	32	26
SMI 13	2,2	3		89	87	84	73	63	60	48	40
SMI 17	3	4		123	118	112	100	93	84	72	59
SMI 20	3	4		140	133	125	115	99	90	80	65
SMI 24	4	5,5		165	158	153	130	119	107	94	80
SMI 30	5,5	7,5		210	200	183	169	150	140	115	98
SMI 35	7,5	10		244	235	220	200	180	171	140	118

Dimensiones / Dimensions / Dimensions

Materiales tipo A
 Impulsor: Noryl
 Difusor: Noryl
 Eje: Acero inox.
 Camisa: Acero inox.

Material type A
 Impeller: Noryl
 Diffuser: Noryl
 Shaft: St. steel
 Shell: St. steel

Materiaux type A
 Roue: Noryl
 Diffuseur: Noryl
 Arbre: Acier inox.
 Chemise: Acier inox.

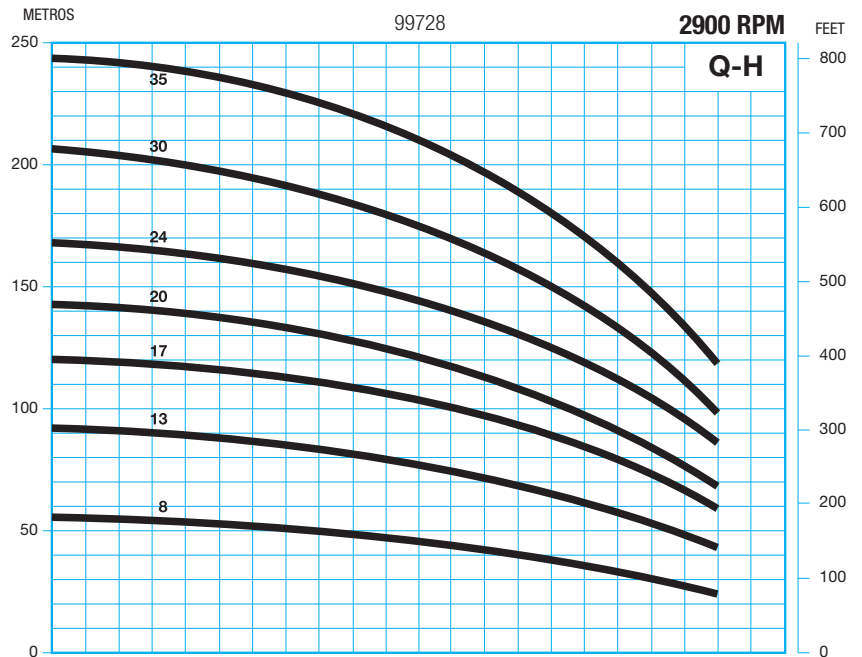
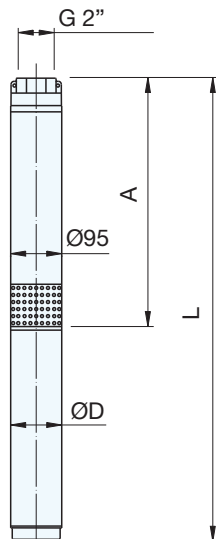

50Hz

Tipo Type	Motor - Moteur		D mm	A mm	L mm	Peso Weight Poids (kg)
	KW	HP				
SMI 8	1,5	2	95	651	1092	18
SMI 13	2,2	3	95	914	1415	21,2
SMI 17	3	4	95	1179	1740	28,2
SMI 20	3	4	95	1340	1901	29,3
SMI 24	4	5,5	95	1547	2148	35,9
SMI 30	5,5	7,5	95	1922	2643	43,7
SMI 35	7,5	10	95	2185	3026	60,4

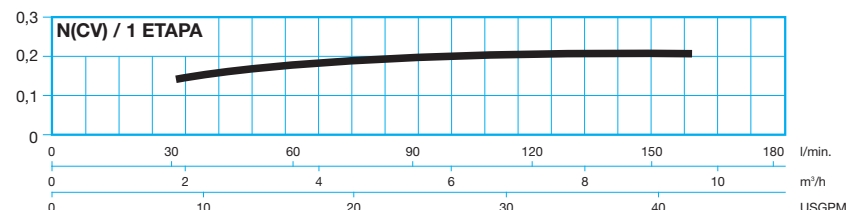
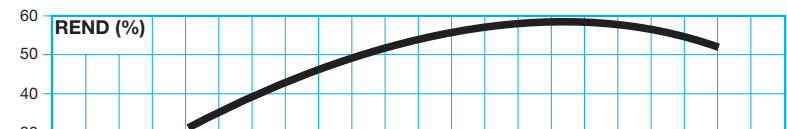

BOMBA TIPO: RADIAL
 TEMP. MAX. LIQUIDO: 30°
 MAX. ARENA: 200 gr/m³
 SENTIDO ROT.: ANTIHORARIO
 VALV. RET.: INCORPORADA

PUMP TYPE: RADIAL
 MAXI. TEMP. LIQUID: 30°
 SAND MAX.: 200 gr/m³
 ROTATION: C.C.W.
 CHECK VAL.: BUILT-IN

POMPE TYPE: RADIALE
 TEMP. MAX. LIQUIDE: 30°
 MAX. SABLE: 200 gr/m³
 SENS. ROT.: ANTIHORAIRE
 CLAPET RET.: INCORPORÉ

Tablas de selección / Selection charts / Tables de selection

Tipo Type	Motor - Moteur		l/min. m ³ /h	Caudal - Capacity - Debit							
	KW	HP		0	83	117	133	167	200	233	267
				0	5	7	8	10	12	14	16
SPI 7	1,5	2	m.c.a.	45	35	30	29	26	23	20	16
SPI 10	2,2	3		62	51	46	44	39	34	29	23
SPI 13	3	4		82	70	64	61	56	50	46	35
SPI 17	4	5,5		110	92	85	82	75	65	55	45
SPI 22	5,5	7,5		140	120	113	109	100	90	79	61
SPI 28	7,5	10		180	155	145	142	130	117	102	83

Dimensiones / Dimensions / Dimensions

Materiales tipo A
 Impulsor: Noryl
 Difusor: Noryl
 Eje: Acero inox.
 Camisa: Acero inox.

Material type A
 Impeller: Noryl
 Diffuser: Noryl
 Shaft: St. steel
 Shell: St. steel

Materiaux type A
 Roue: Noryl
 Diffuseur: Noryl
 Arbre: Acier inox.
 Chemise: Acier inox.

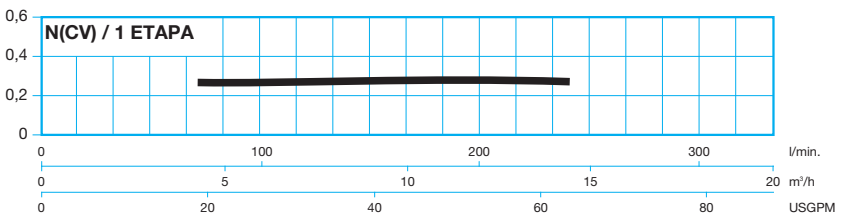
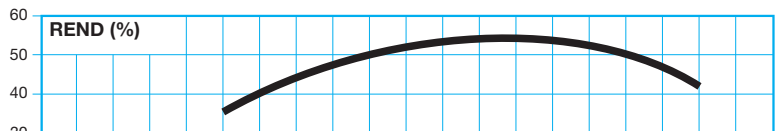
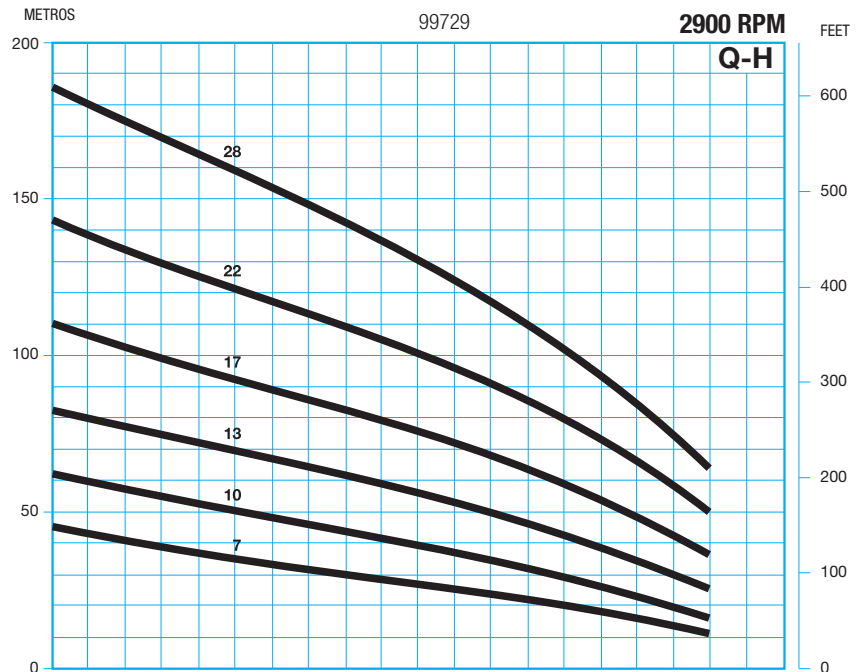
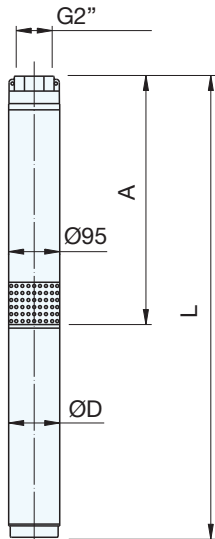

Tipo Type	Motor - Moteur		D mm	A mm	L mm	Peso Weight Poids (kg)
	KW	HP				
SPI 7	1,5	2	95	701	1142	18,8
SPI 10	2,2	3	95	905	1406	21,4
SPI 13	3	4	95	1220	1781	28,5
SPI 17	4	5,5	95	1610	2211	36,2
SPI 22	5,5	7,5	95	2066	2787	44,8
SPI 28	7,5	10	95	2616	3457	60,3

BOMBA TIPO: RADIAL
 TEMP. MAX. LIQUIDO: 30°
 MAX. ARENA: 200 gr/m³
 SENTIDO ROT.: ANTIHORARIO
 VALV. RET.: INCORPORADA

PUMP TYPE: RADIAL
 MAXI. TEMP. LIQUID: 30°
 SAND MAX.: 200 gr/m³
 ROTATION: C.C.W.
 CHECK VAL.: BUILT-IN

POMPE TYPE: RADIALE
 TEMP. MAX. LIQUIDE: 30°
 MAX. SABLE: 200 gr/m³
 SENS. ROT.: ANTIHORAIRE
 CLAPET RET.: INCORPORÉ

Tablas de selección / Selection charts / Tables de selection

Tipo Type	Motor - Moteur		l/min. m³/h	Caudal - Capacity - Debit							
	KW	HP		0	100	150	200	233	267	300	333
				0	6	9	12	14	16	18	20
SQI 7	2,2	3	m.c.a.	45	35	32	30	28	25	22	19
SQI 10	3	4		55	50	47	44	40	36	33	28
SQI 14	4	5,5		83	72	66	60	56	50	43	36
SQI 18	5,5	7,5		98	89	81	78	71	63	55	46
SQI 24	7,5	10		145	130	118	110	104	91	84	72

Dimensiones / Dimensions / Dimensions

Materiales tipo A
 Impulsor: Noryl
 Difusor: Noryl
 Eje: Acero inox.
 Camisa: Acero inox.

Material type A
 Impeller: Noryl
 Diffuser: Noryl
 Shaft: St. steel
 Shell: St. steel

Materiaux type A
 Roue: Noryl
 Diffuseur: Noryl
 Arbre: Acier inox.
 Chemise: Acier inox.

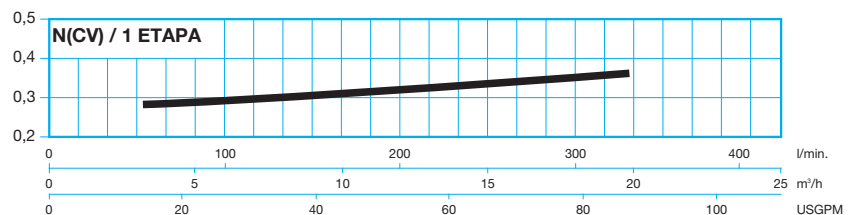
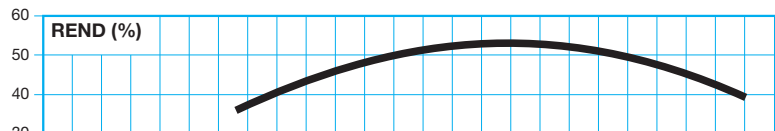
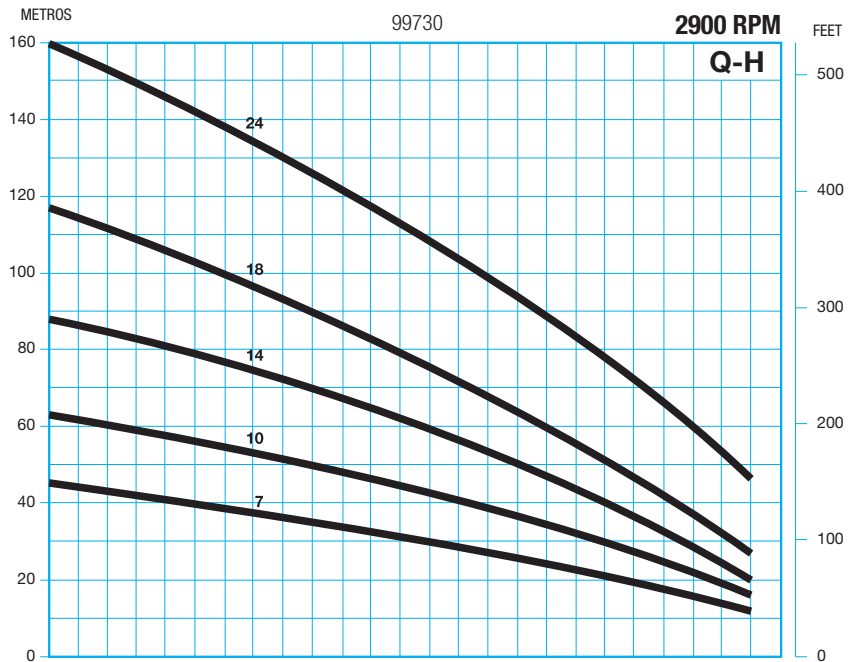
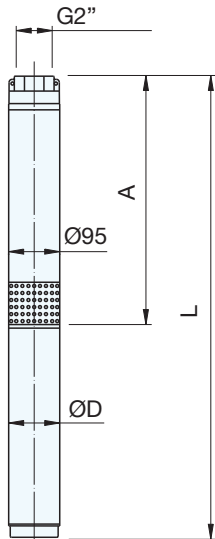

Tipo Type	Motor - Moteur		D mm	A mm	L mm	Peso Weight Poids (kg)
	KW	HP				
SQI 7	2,2	3	95	701	1202	20,2
SQI 10	3	4	95	905	1466	26,2
SQI 14	4	5,5	95	1220	1821	33,2
SQI 18	5,5	7,5	95	1536	2257	41,3
SQI 24	7,5	10	95	2058	2899	59,3

BOMBA TIPO: RADIAL
 TEMP. MAX. LIQUIDO: 30°
 MAX. ARENA: 50 gr/m³
 SENTIDO ROT.: ANTIHORARIO
 VALV. RET.: INCORPORADA

PUMP TYPE: RADIAL
 MAXI. TEMP. LIQUID: 30°
 SAND MAX.: 50 gr/m³
 ROTATION: C.C.W.
 CHECK VAL.: BUILT-IN

POMPE TYPE: RADIALE
 TEMP. MAX. LIQUIDE: 30°
 MAX. SABLE: 50 gr/m³
 SENS. ROT.: ANTIHORAIRE
 CLAPET RET.: INCORPORÉ

Tablas de selección / Selection charts / Tables de selection

Tipo Type	Motor - Moteur		l/min. m ³ /h	Caudal - Capacity - Debit					
	KW	HP		0	133	166	200	233	266
				0	8	10	12	14	16
STI 0,19 - 4	3	4	m.c.a.	69	60	56	51	45	36
STI 0,19 - 6	4	5,5		104	89	84	76	67	54
STI 0,19 - 8	5,5	7,5		138	119	112	102	90	72
STI 0,19 - 11	7,5	10		190	164	154	140	124	100
STI 0,19 - 14	9,2	12,5		242	209	195	178	157	127
STI 0,19 - 16	11	15		276	239	223	205	180	145
STI 0,19 - 19	13	17,5		328	283	265	243	213	172

Dimensiones / Dimensions / Dimensions

Materiales tipo A
 Impulsor: Noryl
 Difusor: Noryl
 Eje: Acero inox.
 Camisa: Acero inox.

Material type A
 Impeller: Noryl
 Diffuser: Noryl
 Shaft: St. steel
 Shell: St. steel

Materiaux type A
 Roue: Noryl
 Diffuseur: Noryl
 Arbre: Acier inox.
 Chemise: Acier inox.

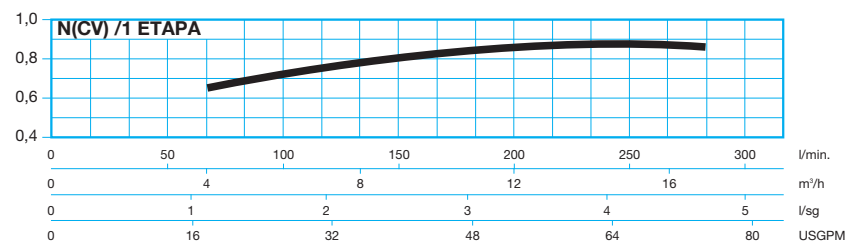
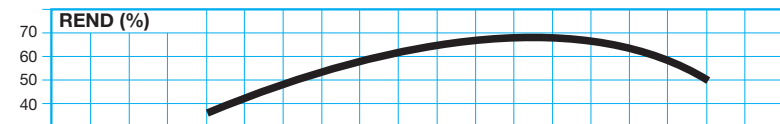
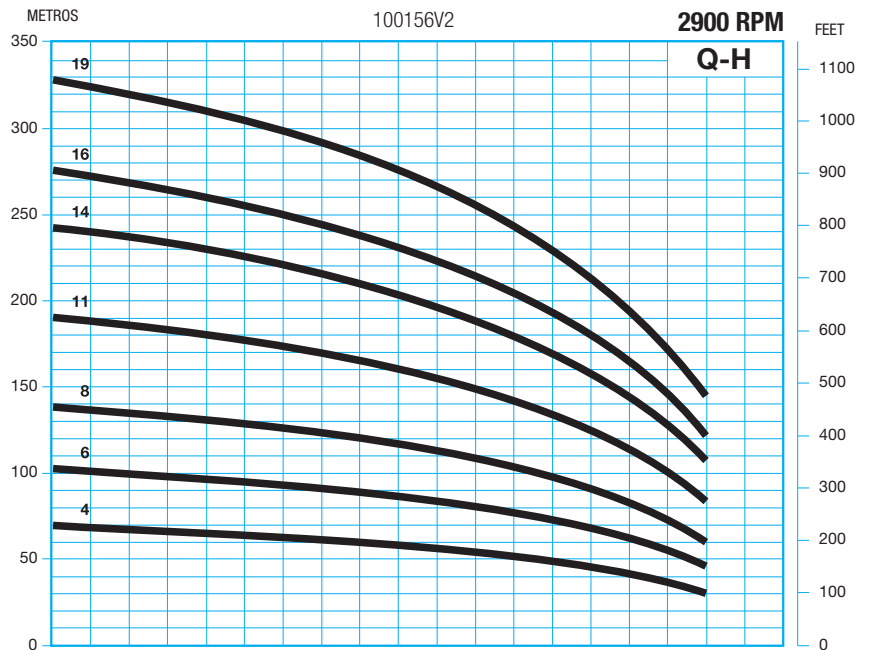
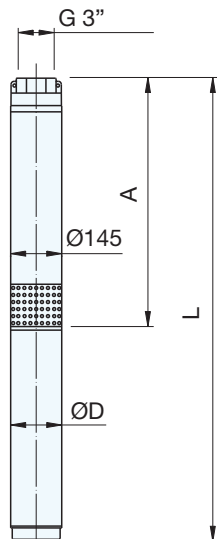

Tipo Type	Motor - Moteur		D mm	A mm	L mm	Peso Weight Poids (kg)
	KW	HP				
STI 0,19-4	3	4	95	460	878	24,5
STI 0,19-6	4	5,5	95	580	1048	28,7
STI 0,19-8	5,5	7,5	95	700	1238	33,7
STI 0,19-11	7,5	10	142	810	1410	58,4
STI 0,19-14	9,2	12,5	142	885	1485	62,2
STI 0,19-16	11	15	142	1005	1705	66,9
STI 0,19-19	13	17,5	142	1185	1885	71,4

BOMBA TIPO: RADIAL
 TEMP. MAX. LIQUIDO: 30°
 MAX. ARENA: 50 gr/m³
 SENTIDO ROT.: ANTIHORARIO
 VALV. RET.: INCORPORADA

PUMP TYPE: RADIAL
 MAXI. TEMP. LIQUID: 30°
 SAND MAX.: 50 gr/m³
 ROTATION: C.C.W.
 CHECK VAL.: BUILT-IN

POMPE TYPE: RADIALE
 TEMP. MAX. LIQUIDE: 30°
 MAX. SABLE: 50 gr/m³
 SENS. ROT.: ANTIHORAIRE
 CLAPET RET.: INCORPORÉ

Tablas de selección / Selection charts / Tables de selection

Tipo Type	Motor - Moteur		l/min. m³/h	Caudal - Capacity - Debit					
	KW	HP		0	233	266	300	333	416
STI 0,21 - 3	3	4	m.c.a.	46	37	34	31	28	19
STI 0,21 - 5	4	5,5		77	61	56	51	46	31
STI 0,21 - 7	5,5	7,5		108	85	79	72	65	44
STI 0,21 - 9	7,5	10		138	110	101	92	84	56
STI 0,21 - 11	9,2	12,5		169	133	124	113	102	69
STI 0,21 - 14	11	15		215	170	157	145	130	88
STI 0,21 - 16	13	17,5		246	195	180	165	149	100
STI 0,21 - 18	15	20		277	219	202	185	167	113
STI 0,21 - 22	18,5	25		345	269	247	226	204	138
STI 0,21 - 25	22	30		384	303	281	258	232	157

Dimensiones / Dimensions / Dimensions

Materiales tipo A
 Impulsor: Noryl
 Difusor: Noryl
 Eje: Acero inox.
 Camisa: Acero inox.

Material type A
 Impeller: Noryl
 Diffuser: Noryl
 Shaft: St. steel
 Shell: St. steel

Materiaux type A
 Roue: Noryl
 Diffuseur: Noryl
 Arbre: Acier inox.
 Chemise: Acier inox.

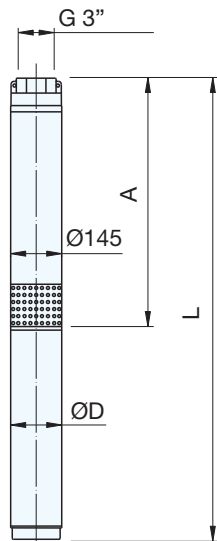

Tipo Type	Motor - Moteur		D mm	A mm	L mm	Peso Weight Poids (kg)
	KW	HP				
STI 0,21-3	3	4	95	535	953	26,8
STI 0,21-5	4	5,5	95	630	1098	30,3
STI 0,21-7	5,5	7,5	95	720	1258	34,5
STI 0,21-9	7,5	10	142	815	1415	58,5
STI 0,21-11	9,2	12,5	142	905	1505	62,8
STI 0,21-14	11	15	142	1045	1745	67,7
STI 0,21-16	13	17,5	142	1135	1835	72,5
STI 0,21-18	15	20	142	1270	2030	77,1
STI 0,21-22	18,5	25	142	1624	2454	94,1
STI 0,21-25	22	30	142	1764	2654	101

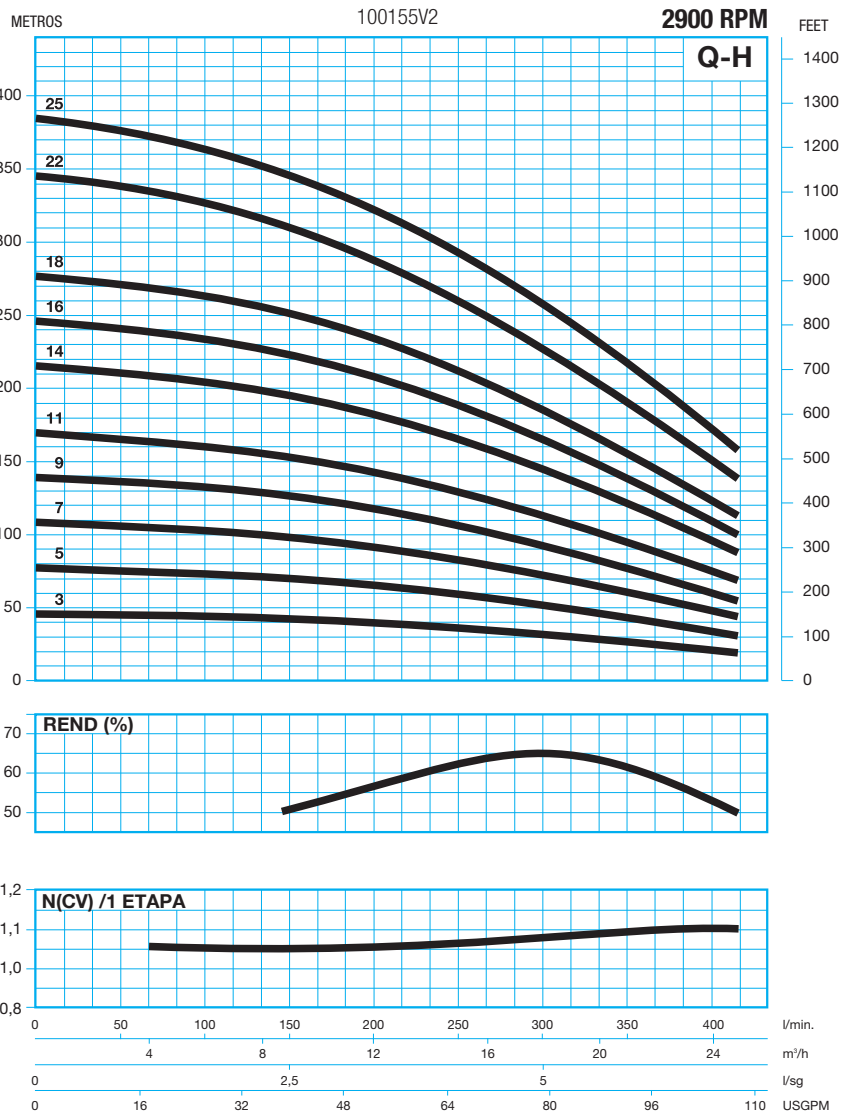

50Hz

BOMBA TIPO: RADIAL
 TEMP. MAX. LIQUIDO: 30°
 MAX. ARENA: 50 gr/m³
 SENTIDO ROT.: ANTIHORARIO
 VALV. RET.: INCORPORADA

PUMP TYPE: RADIAL
 MAXI. TEMP. LIQUID: 30°
 SAND MAX.: 50 gr/m³
 ROTATION: C.C.W.
 CHECK VAL.: BUILT-IN

POMPE TYPE: RADIALE
 TEMP. MAX. LIQUIDE: 30°
 MAX. SABLE: 50 gr/m³
 SENS. ROT.: ANTIHORAIRE
 CLAPET RET.: INCORPORÉ

Tablas de selección / Selection charts / Tables de selection

Tipo Type	Motor - Moteur		l/min. m ³ /h	Caudal - Capacity - Debit					
	KW	HP		0	333	433	533	583	633
STI 0,26 - 4	5,5	7,5	m.c.a.	59	53	48	42	38	33
STI 0,26 - 6	7,5	10		88	78	71	60	54	48
STI 0,26 - 7	9,2	12,5		105	95	86	75	69	63
STI 0,26 - 8	11	15		120	108	98	86	79	72
STI 0,26 - 9	13	17,5		135	123	110	98	90	82
STI 0,26 - 10	15	20		147	131	120	102	92	91
STI 0,26 - 13	18,5	25		197	175	159	134	125	109
STI 0,26 - 15	22	30		230	208	183	153	138	123
STI 0,26 - 18	26	35		275	248	220	185	166	148

Dimensiones / Dimensions / Dimensions

Materiales tipo A
 Impulsor: Noryl
 Difusor: Noryl
 Eje: Acero inox.
 Camisa: Acero inox.

Material type A
 Impeller: Noryl
 Diffuser: Noryl
 Shaft: St. steel
 Shell: St. steel

Materiaux type A
 Roue: Noryl
 Diffuseur: Noryl
 Arbre: Acier inox.
 Chemise: Acier inox.

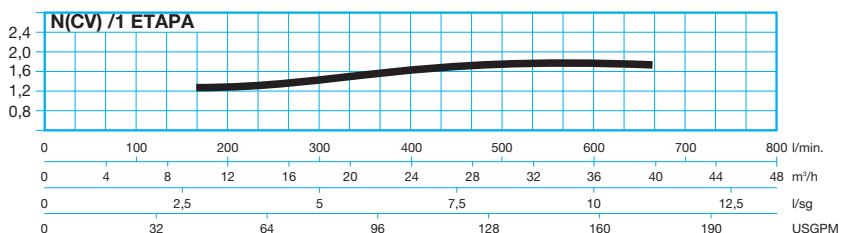
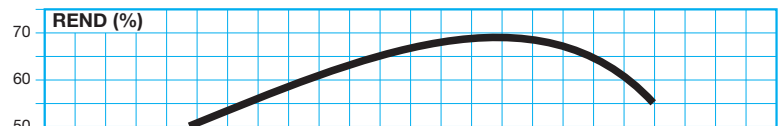
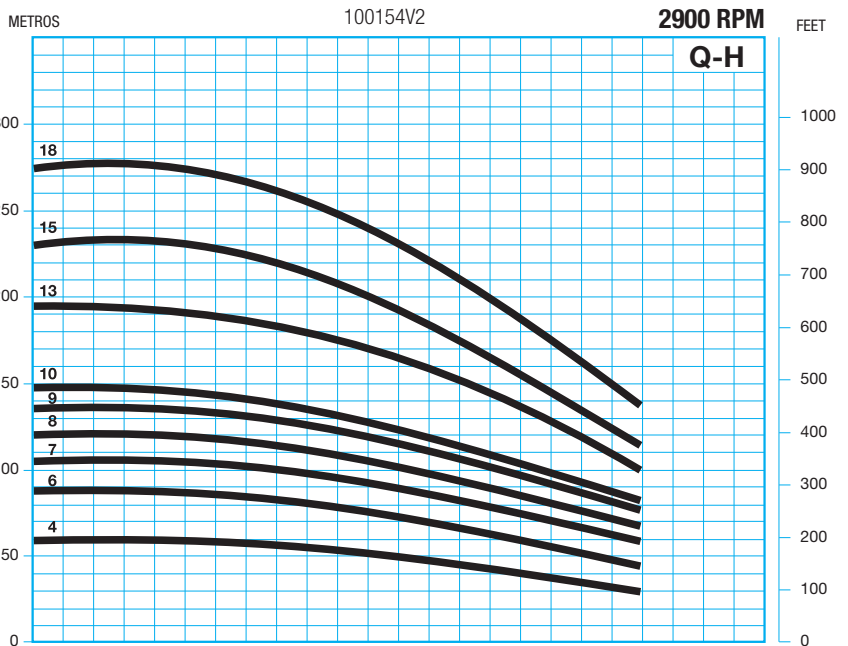
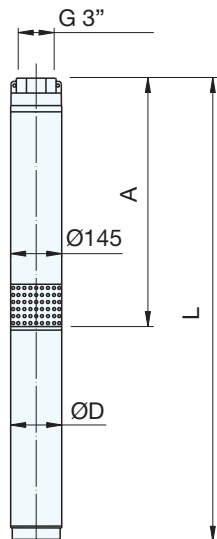

Tipo Type	Motor - Moteur		D mm	A mm	L mm	Peso Weight Poids (kg)
	KW	HP				
STI 0,26-4	5,5	7,5	95	680	1218	33,4
STI 0,26-6	7,5	10	142	810	1410	58,5
STI 0,26-7	9,2	12,5	142	875	1475	62,5
STI 0,26-8	11	15	142	940	1640	66,3
STI 0,26-9	13	17,5	142	1005	1705	69,5
STI 0,26-10	15	20	142	1070	1830	74
STI 0,26-13	18,5	25	142	1265	2095	87,6
STI 0,26-15	22	30	142	1435	2324	94,9
STI 0,26-18	26	35	142	1630	2660	117,9

BOMBA TIPO: RADIAL
 TEMP. MAX. LIQUIDO: 30°
 MAX. ARENA: 40 gr/m³
 SENTIDO ROT.: ANTIHORARIO
 VALV. RET.: INCORPORADA

PUMP TYPE: RADIAL
 MAXI. TEMP. LIQUID: 30°
 SAND MAX.: 40 gr/m³
 ROTATION: C.C.W.
 CHECK VAL.: BUILT-IN

POMPE TYPE: RADIALE
 TEMP. MAX. LIQUIDE: 30°
 MAX. SABLE: 40 gr/m³
 SENS. ROT.: ANTIHORAIRE
 CLAPET RET.: INCORPORÉ

Tablas de selección / Selection charts / Tables de selection

Tipo Type	Motor - Moteur		l/min. m ³ /h	Caudal - Capacity - Debit						
	KW	HP		0	300	400	500	600	700	800
ST 0,36 - 5	7,5	10	m.c.a.	78	72	66	59	50	36	18
ST 0,36 - 6	9,2	12,5		94	86	79	71	59	44	22
ST 0,36 - 8	11	15		126	114	106	94	79	58	29
ST 0,36 - 9	13	17,5		141	129	119	106	89	65	32
ST 0,36 - 12	18,5	25		188	172	158	142	119	87	43
ST 0,36 - 18	26	35		283	257	238	212	178	131	65
ST 0,36 - 20	30	40		314	286	264	236	198	145	72
ST 0,36 - 28	45	60		438	400	370	330	277	203	101

Dimensiones / Dimensions / Dimensions

Materiales tipo A
 Impulsor: Noryl
 Difusor: Noryl
 Eje: Acero inox.
 Camisa: Acero inox.

Material type A
 Impeller: Noryl
 Diffuser: Noryl
 Shaft: St. steel
 Shell: St. steel

Materiaux type A
 Roue: Noryl
 Diffuseur: Noryl
 Arbre: Acier inox.
 Chemise: Acier inox.

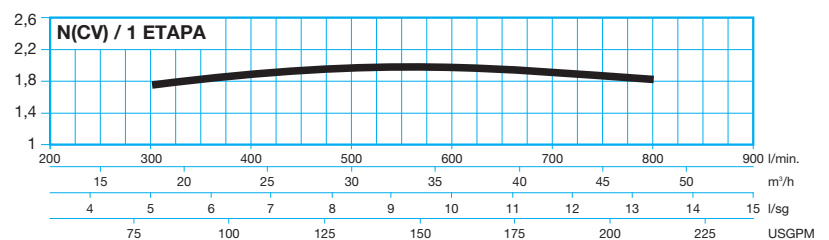
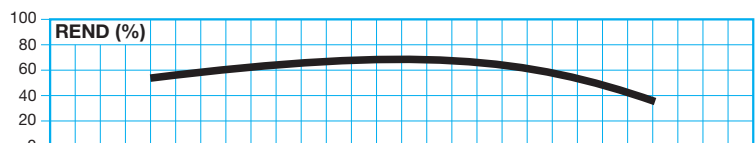
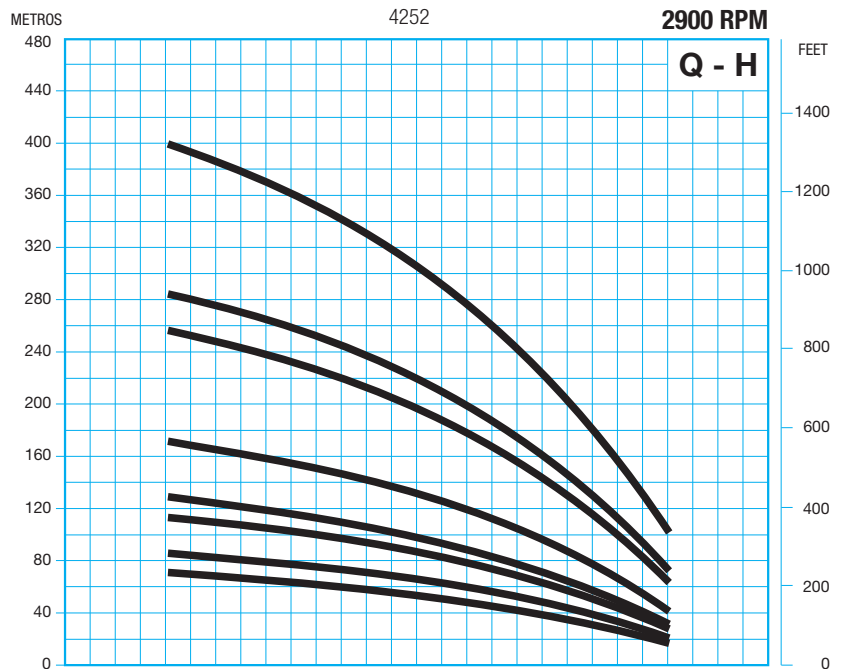
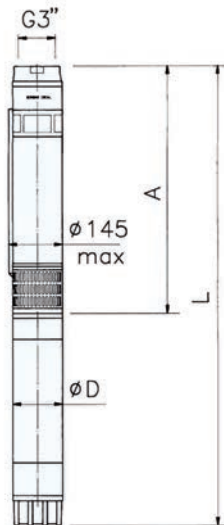

Tipo Type	Motor - Moteur		D mm	A mm	L mm	Peso Weight Poids (kg)
	KW	HP				
ST 0,36-5	7,5	10	142	588	1328	54
ST 0,36-6	9,2	12,5	142	648	1420	59
ST 0,36-8	11	15	142	768	1573	64
ST 0,36-9	13	17,5	142	828	1698	71
ST 0,36-12	18,5	25	142	1008	1943	80
ST 0,36-18	26	35	142	1420	2550	105
ST 0,36-20	30	40	142	1540	2670	107
ST 0,36-28	45	60	142	2143	3418	173

BOMBA TIPO: RADIAL
 TEMP. MAX. LIQUIDO: 30°
 MAX. ARENA: 40 gr/m³
 SENTIDO ROT.: ANTIHORARIO
 VALV. RET.: INCORPORADA

PUMP TYPE: RADIAL
 MAXI. TEMP. LIQUID: 30°
 SAND MAX.: 40 gr/m³
 ROTATION: C.C.W.
 CHECK VAL.: BUILT-IN

POMPE TYPE: RADIALE
 TEMP. MAX. LIQUIDE: 30°
 MAX. SABLE: 40 gr/m³
 SENS. ROT.: ANTIHORAIRE
 CLAPET RET.: INCORPORÉ

Tablas de selección / Selection charts / Tables de selection

Tipo Type	Motor - Moteur		l/min. m ³ /h	Caudal - Capacity - Debit							
	KW	HP		0	500	600	700	800	900	1000	1100
ST 0,42 - 6	11	15	m.c.a.	78	63	58	51	43	34	24	12
ST 0,42 - 9	15	20		118	95	86	77	65	51	36	18
ST 0,42 - 10	18,5	25		131	106	96	85	72	57	40	20
ST 0,42 - 12	22	30		158	127	115	102	86	68	48	24
ST 0,42 - 15	26	35		197	158	144	128	108	86	60	30

Dimensiones / Dimensions / Dimensions

Materiales tipo A
 Impulsor: Noryl
 Difusor: Noryl
 Eje: Acero inox.
 Camisa: Acero inox.

Material type A
 Impeller: Noryl
 Diffuser: Noryl
 Shaft: St. steel
 Shell: St. steel

Materiaux type A
 Roue: Noryl
 Diffuseur: Noryl
 Arbre: Acier inox.
 Chemise: Acier inox.

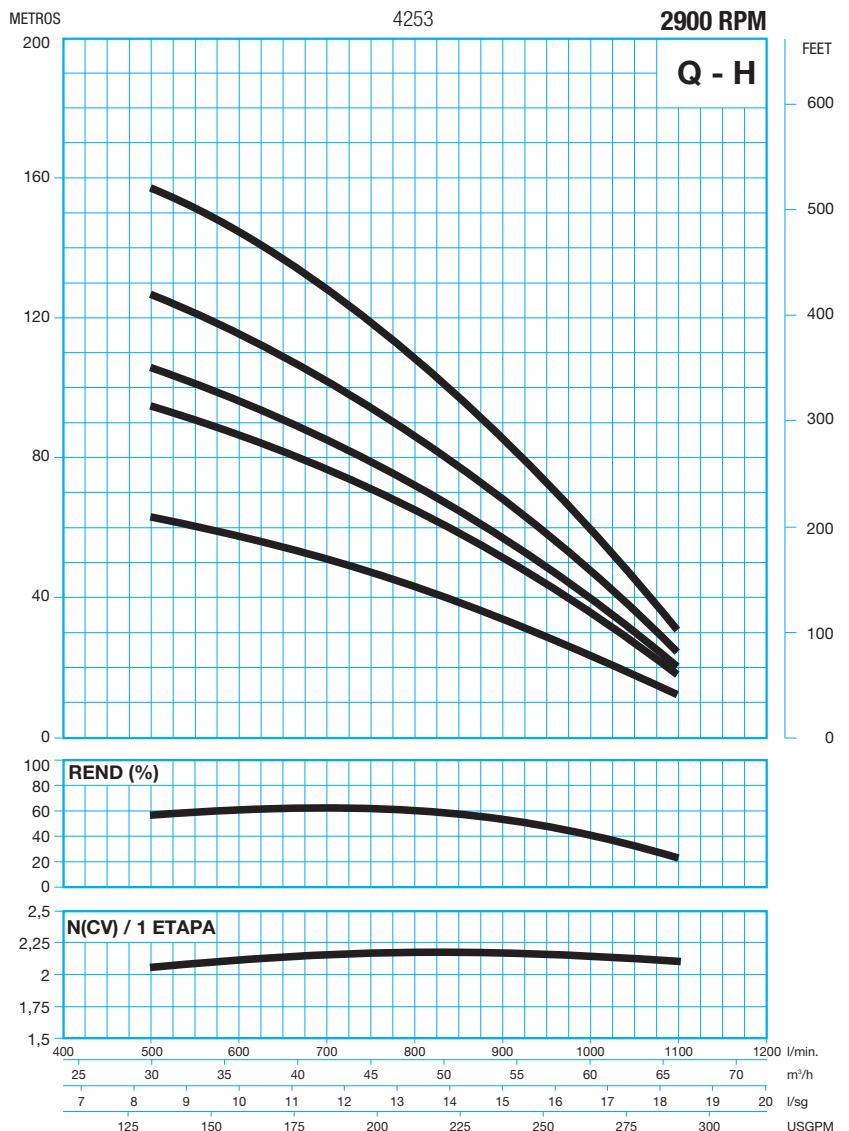
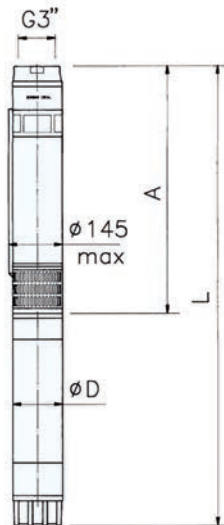

Tipo Type	Motor - Moteur		D mm	A mm	L mm	Peso Weight Poids (kg)
	KW	HP				
ST 0,42-6	11	15	142	648	1453	62
ST 0,42-9	15	20	142	828	1698	71
ST 0,42-10	18,5	25	142	888	1823	79
ST 0,42-12	22	30	142	1008	2008	86
ST 0,42-15	26	35	142	1188	2318	102

BOMBA TIPO: RADIAL
 TEMP. MAX. LIQUIDO: 30°
 MAX. ARENA: 40 gr/m³
 SENTIDO ROT.: ANTIHORARIO
 VALV. RET.: INCORPORADA

PUMP TYPE: RADIAL
 MAXI. TEMP. LIQUID: 30°
 SAND MAX.: 40 gr/m³
 ROTATION: C.C.W.
 CHECK VAL.: BUILT-IN

POMPE TYPE: RADIALE
 TEMP. MAX. LIQUIDE: 30°
 MAX. SABLE: 40 gr/m³
 SENS. ROT.: ANTIHORAIRE
 CLAPET RET.: INCORPORÉ

Tablas de selección / Selection charts / Tables de selection

Tipo Type	Motor - Moteur		l/min. m ³ /h	Caudal - Capacity - Debit				
	KW	HP		0	33	42	50	67
TXI 18/9	0,55	0,75	m.c.a.	54	45	42	38	28
TXI 18/12	0,75	1		72	60	56	51	37
TXI 18/18	1,1	1,5		108	89	84	76	56
TXI 18/25	1,5	2		149	125	117	106	78

Dimensiones / Dimensions / Dimensions

Materiales tipo A
 Impulsor: AISI 304
 Difusor: AISI 304
 Eje: AISI 304

Material type A
 Impeller: AISI 304
 Diffuser: AISI 304
 Shaft: AISI 304

Materiaux type A
 Roue: AISI 304
 Diffuseur: AISI 304
 Arbre: AISI 304

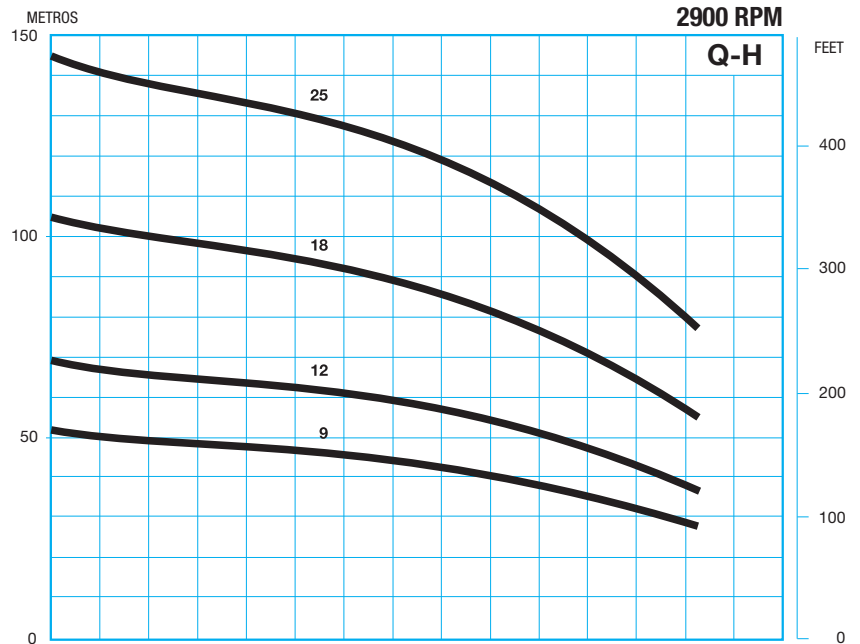
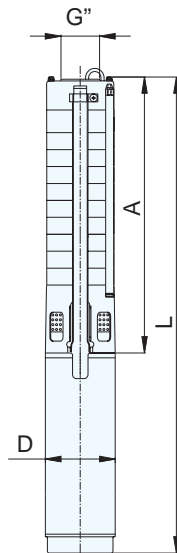

50HZ

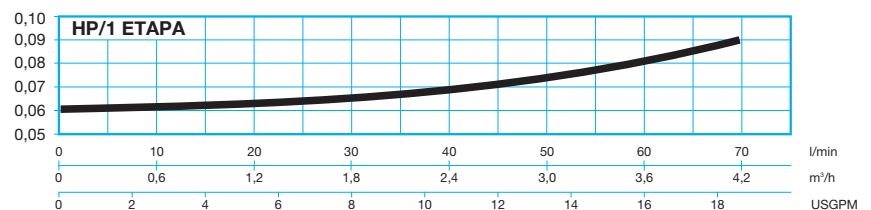

Tipo Type	Motor - Moteur		D mm	A mm	L mm	G"	Peso Weight Poids (kg)
	KW	HP					
TXI 18/9	0,55	0,75	95	354	679	1 1/4"	10,1
TXI 18/12	0,75	1	95	417	742	1 1/4"	11,3
TXI 18/18	1,1	1,5	95	543	868	1 1/4"	13,6
TXI 18/25	1,5	2	95	690	1075	1 1/4"	16,7

BOMBA TIPO: RADIAL
 TEMP. MAX. LIQUIDO: 30°
 MAX. ARENA: 40 gr/m³
 SENTIDO ROT.: ANTIHORARIO
 VALV. RET.: INCORPORADA

PUMP TYPE: RADIAL
 MAXI. TEMP. LIQUID: 30°
 SAND MAX.: 40 gr/m³
 ROTATION: C.C.W.
 CHECK VAL.: BUILT-IN

POMPE TYPE: RADIALE
 TEMP. MAX. LIQUIDE: 30°
 MAX. SABLE: 40 gr/m³
 SENS. ROT.: ANTIHORAIRE
 CLAPET RET.: INCORPORÉ

Tablas de selección / Selection charts / Tables de selection

Tipo Type	Motor - Moteur		l/min. m ³ /h	Caudal - Capacity - Debit				
	KW	HP		0	67	83	100	108
TXI 25/8	0,75	1	m.c.a.	48	36	31	25	20
TXI 25/12	1,1	1,5		73	54	46	37	32
TXI 25/17	1,5	2		104	76	63	53	45
TXI 25/25	2,2	3		152	112	94	77	67

Dimensiones / Dimensions / Dimensions

Materiales tipo A
 Impulsor: AISI 304
 Difusor: AISI 304
 Eje: AISI 304

Material type A
 Impeller: AISI 304
 Diffuser: AISI 304
 Shaft: AISI 304

Materiaux type A
 Roue: AISI 304
 Diffuseur: AISI 304
 Arbre: AISI 304

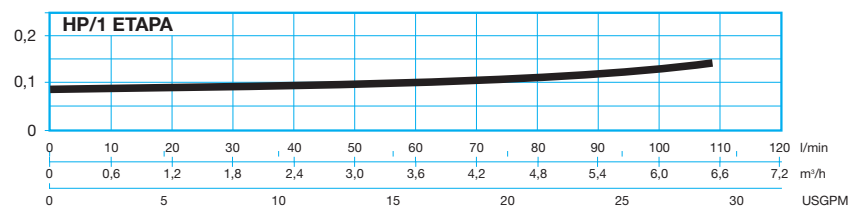
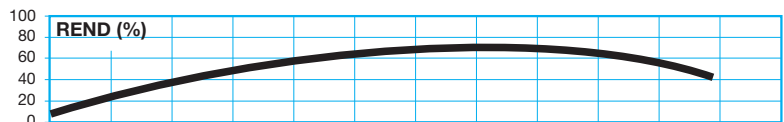
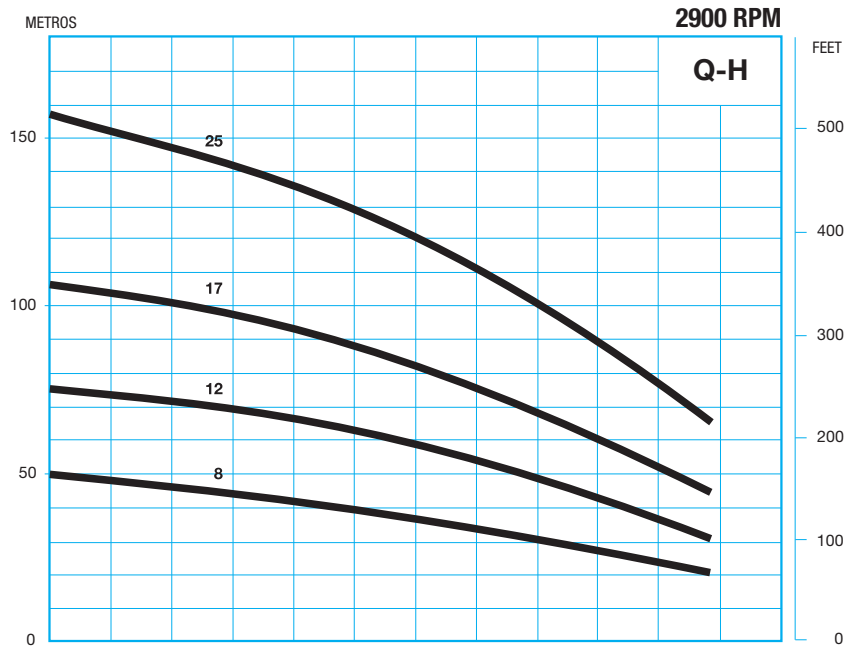
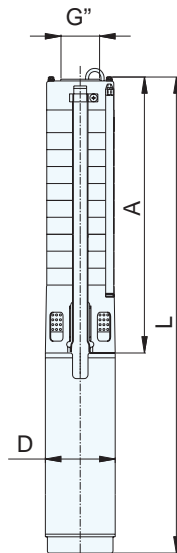

Tipo Type	Motor - Moteur		D mm	A mm	L mm	G"	Peso Weight Poids (kg)
	KW	HP					
TXI 25/8	0,75	1	95	333	658	1 1/2"	10,5
TXI 25/12	1,1	1,5	95	417	742	1 1/2"	12,4
TXI 25/17	1,5	2	95	522	907	1 1/2"	15,1
TXI 25/25	2,2	3	95	690	1073	1 1/2"	17,6

BOMBA TIPO: RADIAL
 TEMP. MAX. LIQUIDO: 30°
 MAX. ARENA: 40 gr/m³
 SENTIDO ROT.: ANTIHORARIO
 VALV. RET.: INCORPORADA

PUMP TYPE: RADIAL
 MAXI. TEMP. LIQUID: 30°
 SAND MAX.: 40 gr/m³
 ROTATION: C.C.W.
 CHECK VAL.: BUILT-IN

POMPE TYPE: RADIALE
 TEMP. MAX. LIQUIDE: 30°
 MAX. SABLE: 40 gr/m³
 SENS. ROT.: ANTIHORAIRE
 CLAPET RET.: INCORPORÉ

Tablas de selección / Selection charts / Tables de selection

Tipo Type	Motor - Moteur		l/min. m ³ /h	Caudal - Capacity - Debit				
	KW	HP		0	100	133	167	183
TXI 40/10	1,5	2	m.c.a.	57	44	38	28	20
TXI 40/15	2,2	3		86	65	57	42	34
TXI 40/18	3	4		103	79	68	50	40
TXI 40/25	4	5,5		143	110	95	70	57
				0	6	8	10	11

Dimensiones / Dimensions / Dimensions

Materiales tipo A
 Impulsor: AISI 304
 Difusor: AISI 304
 Eje: AISI 304

Material type A
 Impeller: AISI 304
 Diffuser: AISI 304
 Shaft: AISI 304

Materiaux type A
 Roue: AISI 304
 Diffuseur: AISI 304
 Arbre: AISI 304

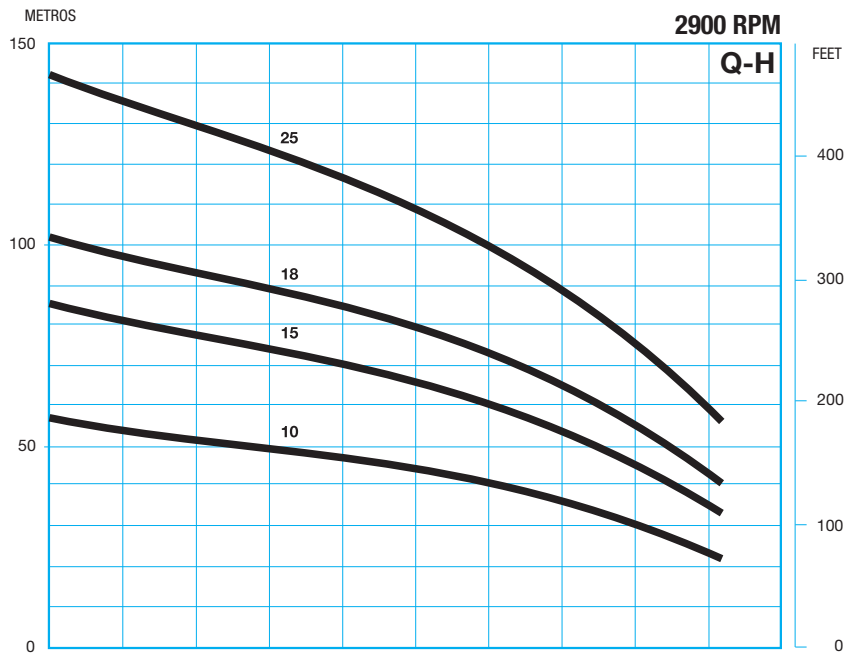
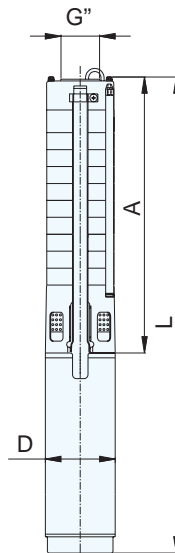

50HZ

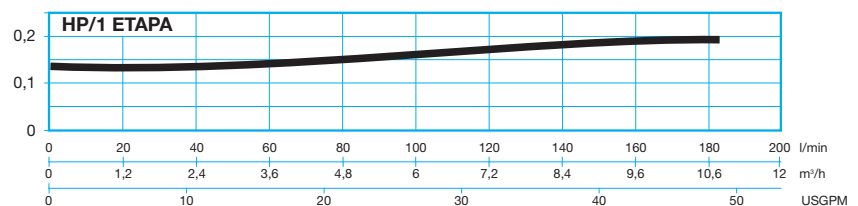

Tipo Type	Motor - Moteur		D mm	A mm	L mm	G"	Peso Weight Poids (kg)
	KW	HP					
TXI 40/10	1,5	2	95	621	1006	2"	17,3
TXI 40/15	2,2	3	95	831	1214	2"	20,6
TXI 40/18	3	4	95	957	1375	2"	24,2
TXI 40/25	4	5,5	95	1251	1719	2"	29,8

BOMBA TIPO: RADIAL
 TEMP. MAX. LIQUIDO: 30°
 MAX. ARENA: 40 gr/m³
 SENTIDO ROT.: ANTIHORARIO
 VALV. RET.: INCORPORADA

PUMP TYPE: RADIAL
 MAXI. TEMP. LIQUID: 30°
 SAND MAX.: 40 gr/m³
 ROTATION: C.C.W.
 CHECK VAL.: BUILT-IN

POMPE TYPE: RADIALE
 TEMP. MAX. LIQUIDE: 30°
 MAX. SABLE: 40 gr/m³
 SENS. ROT.: ANTIHORAIRE
 CLAPET RET.: INCORPORÉ

Tablas de selección / Selection charts / Tables de selection

Tipo Type	Motor - Moteur		l/min. m ³ /h	Caudal - Capacity - Debit				
	KW	HP		0	167	233	267	317
TXI 75/5	1,5	2	m.c.a.	31	27	21	19	13
TXI 75/7	2,2	3		44	37	31	27	20
TXI 75/13	4	5,5		82	70	57	50	35
TXI 75/18	5,5	7,5		113	96	80	70	50

Dimensiones / Dimensions / Dimensions

Materiales tipo A
 Impulsor: AISI 304
 Difusor: AISI 304
 Eje: AISI 304

Material type A
 Impeller: AISI 304
 Diffuser: AISI 304
 Shaft: AISI 304

Materiaux type A
 Roue: AISI 304
 Diffuseur: AISI 304
 Arbre: AISI 304

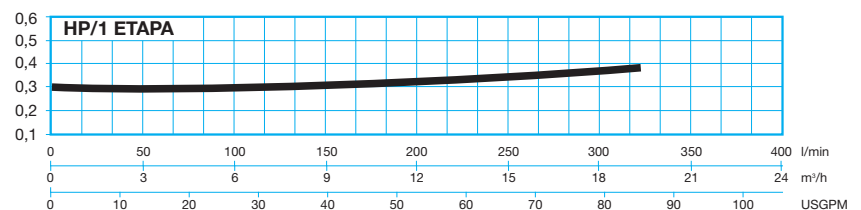
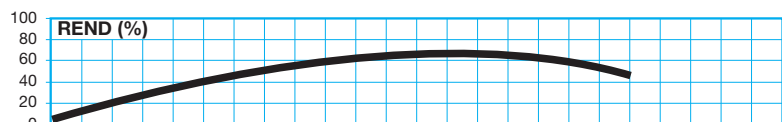
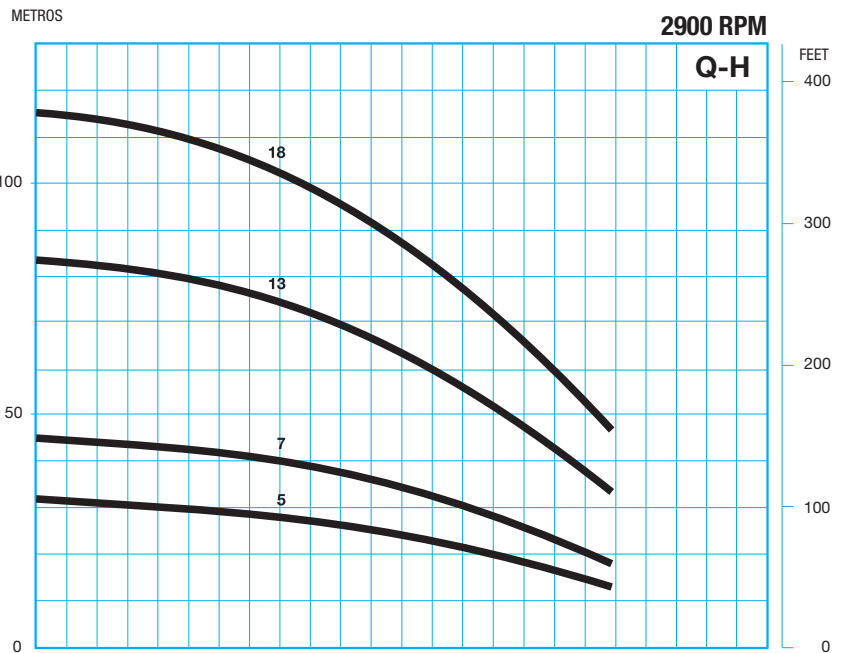
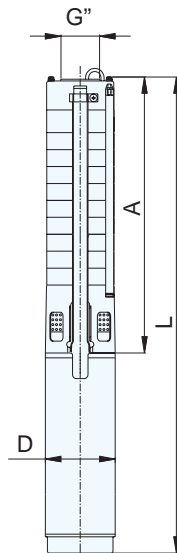

Tipo Type	Motor - Moteur		D mm	A mm	L mm	G"	Peso Weight Poids (kg)
	KW	HP					
TXI 75/5	1,5	2	95	503	888	2"	15,3
TXI 75/7	2,2	3	95	633	1016	2"	17,1
TXI 75/13	4	5,5	95	1023	1491	2"	24,5
TXI 75/18	5,5	7,5	95	1348	1886	2"	30,3

BOMBA TIPO: RADIAL
 TEMP. MAX. LIQUIDO: 30°
 MAX. ARENA: 50 gr/m³
 SENTIDO ROT.: ANTIHORARIO
 VALV. RET.: INCORPORADA

PUMP TYPE: RADIAL
 MAXI. TEMP. LIQUID: 30°
 SAND MAX.: 50 gr/m³
 ROTATION: C.C.W.
 CHECK VAL.: BUILT-IN

POMPE TYPE: RADIALE
 TEMP. MAX. LIQUIDE: 30°
 MAX. SABLE: 50 gr/m³
 SENS. ROT.: ANTIHORAIRE
 CLAPET RET.: INCORPORÉ

Tablas de selección / Selection charts / Tables de selection

Tipo Type	Motor - Moteur		l/min. m ³ /h	Caudal - Capacity - Debit						
	KW	HP		0	133	167	200	217	233	267
				0	8	10	12	13	14	16
SXT 10/8	4	5,5	m.c.a.	75	70	66	59	56	52	42
SXT 10/9	4	5,5		85	79	74	67	63	58	48
SXT 10/10	4	5,5		94	88	82	74	70	65	53
SXT 10/12	5,5	7,5		113	105	98	89	84	78	64
SXT 10/14	5,5	7,5		132	123	115	104	98	91	74
SXT 10/16	7,5	10		150	141	131	119	112	104	85
SXT 10/18	7,5	10		169	158	148	134	126	116	95
SXT 10/19	,5	10		179	167	156	141	133	123	101
SXT 10/21	9,3	12,5		198	184	172	156	147	136	111
SXT 10/23	9,3	12,5		216	202	189	171	161	149	122
SXT 10/24	9,3	12,5		226	211	197	178	168	155	127
SXT 10/26	11	15		245	228	213	193	181	168	138
SXT 10/28	11	15		263	246	230	208	195	181	148
SXT 10/30	11	15		282	264	246	223	209	194	159
SXT 10/33	13	17,5		310	290	271	245	230	214	175
SXT 10/35	13	17,5		329	307	287	260	244	227	186
SXT 10/37	15	20		348	325	304	275	258	239	196

Dimensiones / Dimensions / Dimensions

Materiales tipo A
 Impulsor: AISI 304L
 Difusor: AISI 304L
 Eje: AISI 420
 Camisa AISI 304

Material type A
 Impeller: AISI 304L
 Diffuser: AISI 304L
 Shaft: AISI 420
 Shell: AISI 304

Materiaux type A
 Roue: AISI 304L
 Diffuseur: AISI 304L
 Arbre: AISI 420
 Chemise: AISI 304

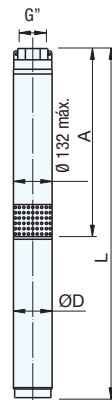

Tipo Type	Motor - Moteur		D mm	A mm	L mm	G"	Peso Weight Poids (kg)
	KW	HP					
SXT 10/8	4	5,5	90	746	1205	2 1/2"	59
SXT 10/9	4	5,5	90	806	1297	2 1/2"	61
SXT 10/10	4	5,5	90	868	1336	2 1/2"	62
SXT 10/12	5,5	7,5	90	986	1515	2 1/2"	68
SXT 10/14	5,5	7,5	90	1107	1678	2 1/2"	70
SXT 10/16	7,5	10	142	1231	2061	2 1/2"	79
SXT 10/18	7,5	10	142	1349	2116	2 1/2"	82
SXT 10/19	,5	10	142	1407	2191	2 1/2"	83
SXT 10/21	9,3	12,5	142	1533	2301	2 1/2"	90
SXT 10/23	9,3	12,5	142	1654	2444	2 1/2"	92
SXT 10/24	9,3	12,5	142	1715	2515	2 1/2"	94
SXT 10/26	11	15	142	1835	2969	2 1/2"	100
SXT 10/28	11	15	142	1956	3132	2 1/2"	102
SXT 10/30	11	15	142	2075	3355	2 1/2"	106
SXT 10/33	13	17,5	142	2262	3599	2 1/2"	115
SXT 10/35	13	17,5	142	2379	3824	2 1/2"	117
SXT 10/37	15	20	142	2501	3987	2 1/2"	126

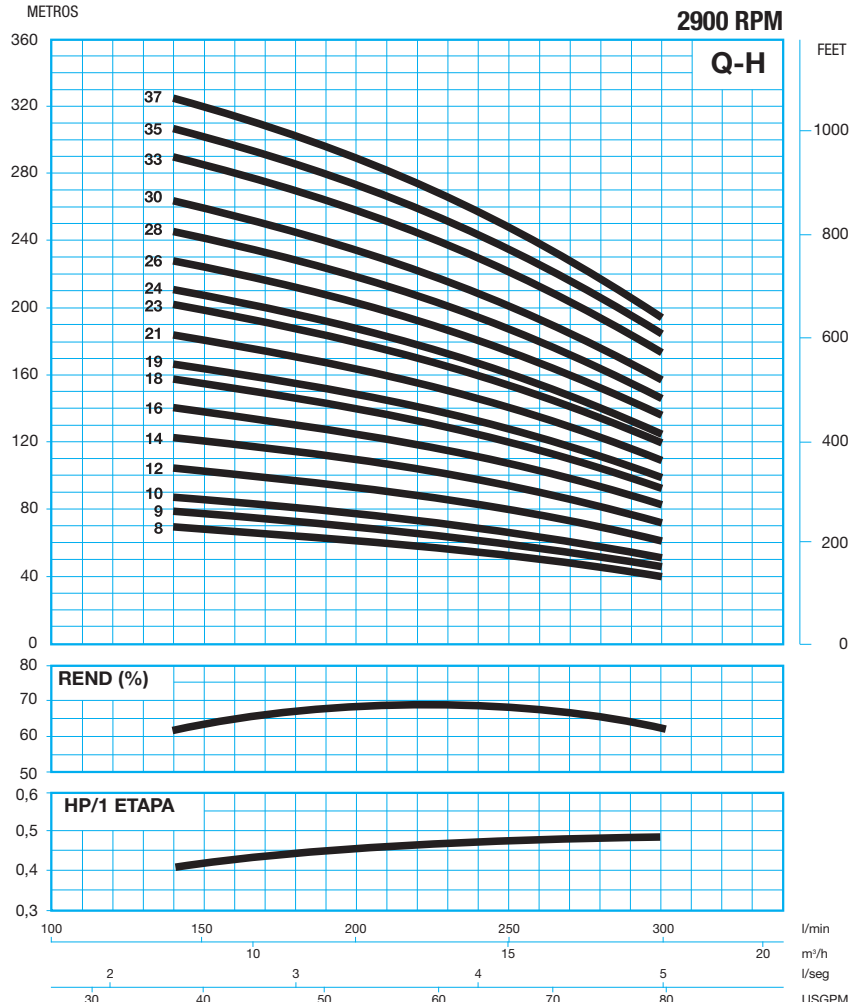

BOMBA TIPO: RADIAL
 TEMP. MAX. LIQUIDO: 30°
 MAX. ARENA: 50 gr/m³
 SENTIDO ROT.: ANTIHORARIO
 VALV. RET.: INCORPORADA

PUMP TYPE: RADIAL
 MAXI. TEMP. LIQUID: 30°
 SAND MAX.: 50 gr/m³
 ROTATION: C.C.W.
 CHECK VAL.: BUILT-IN

POMPE TYPE: RADIALE
 TEMP. MAX. LIQUIDE: 30°
 MAX. SABLE: 50 gr/m³
 SENS. ROT.: ANTIHORAIRE
 CLAPET RET.: INCORPORÉ

Tablas de selección / Selection charts / Tables de selection

Tipo Type	Motor - Moteur		l/min. m ³ /h	Caudal - Capacity - Debit							
	KW	HP		100	160	167	200	233	266	300	334
				6	8	10	12	14	16	18	20
SXT 17/6	4	5,5	m.c.a.	66	63	61	59	55	49	44	38
SXT 17/8	5,5	7,5		88	84	81	78	73	65	59	52
SXT 17/10	5,5	7,5		111	105	104	99	93	85	76	64
SXT 17/11	7,5	10		121	116	112	108	102	89	81	72
SXT 17/13	7,5	10		144	137	136	129	121	111	98	84
SXT 17/15	9,3	12,5		166	156	157	149	139	128	113	96
SXT 17/17	11	15		188	179	177	169	158	145	128	109
SXT 17/18	11	15		197	190	184	176	166	146	133	115
SXT 17/20	11	15		221	211	209	199	186	170	151	128
SXT 17/24	15	20		266	253	250	238	223	204	181	154
SXT 17/27	15	20		299	284	280	267	251	229	205	173
SXT 17/33	18,5	25		365	346	344	328	307	281	249	212
SXT 17/36	22	30		399	380	376	358	335	306	272	231
SXT 17/40	22	30		443	422	417	397	372	340	302	257
SXT 17/48	26,5	35		526	506	492	475	448	392	357	305
SXT 17/53	30	40		578	559	544	522	495	432	397	340
SXT 17/55	37	50	608	580	571	552	523	462	424	367	

Dimensiones / Dimensions / Dimensions

Materiales tipo A
 Impulsor: AISI 304L
 Difusor: AISI 304L
 Eje: AISI 420
 Camisa AISI 304

Material type A
 Impeller: AISI 304L
 Diffuser: AISI 304L
 Shaft: AISI 420
 Shell: AISI 304

Materiaux type A
 Roue: AISI 304L
 Diffuseur: AISI 304L
 Arbre: AISI 420
 Chemise: AISI 304

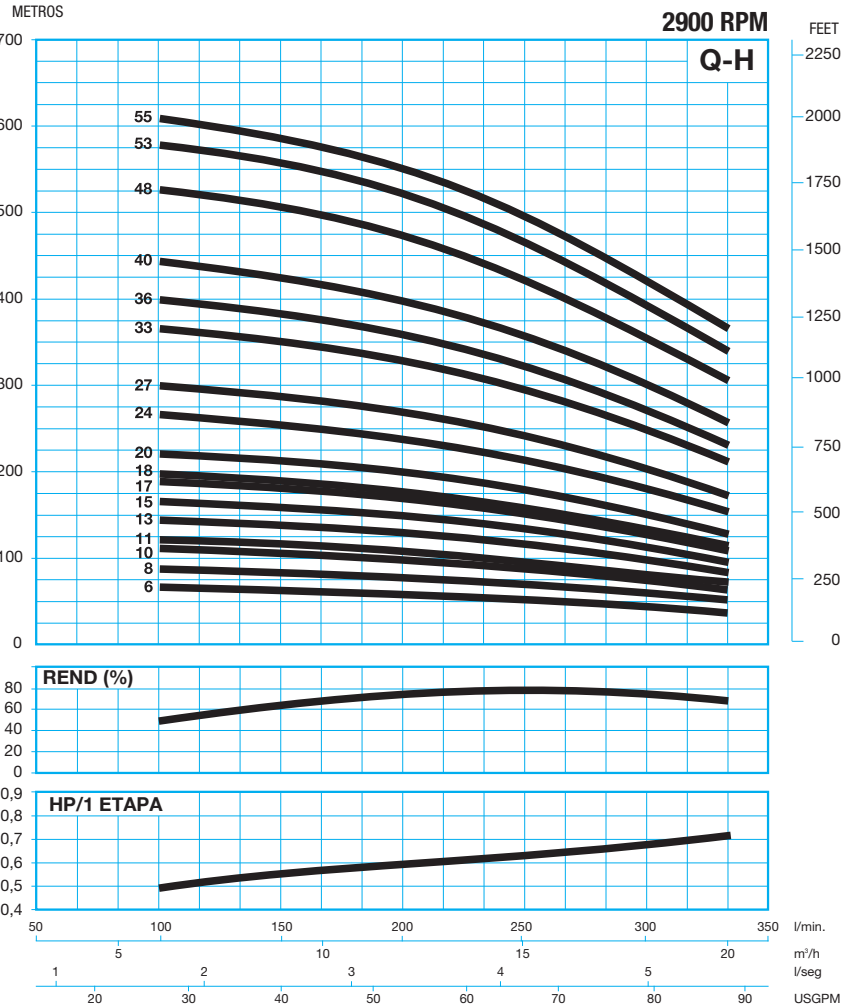
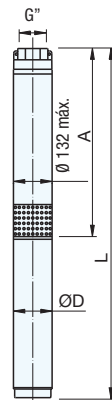

Tipo Type	Motor - Moteur		D mm	A mm	L mm	G"	Peso Weight Poids (kg)
	KW	HP					
SXT 17/6	4	5,5	90	624	1084	2 1/2"	57
SXT 17/8	5,5	7,5	90	746	1275	2 1/2"	62
SXT 17/10	5,5	7,5	90	868	1406	2 1/2"	65
SXT 17/11	7,5	10	142	927	1677	2 1/2"	66
SXT 17/13	7,5	10	142	1044	1796	2 1/2"	75
SXT 17/15	9,3	12,5	142	1171	1963	2 1/2"	82
SXT 17/17	11	15	142	1291	2083	2 1/2"	84
SXT 17/18	11	15	142	1349	2209	2 1/2"	86
SXT 17/20	11	15	142	1473	2318	2 1/2"	92
SXT 17/24	15	20	142	1715	2620	2 1/2"	109
SXT 17/27	15	20	142	1897	2864	2 1/2"	113
SXT 17/33	18,5	25	142	2262	3340	2 1/2"	129
SXT 17/36	22	30	142	2441	3537	2 1/2"	139
SXT 17/40	22	30	142	2683	3779	2 1/2"	144
SXT 17/48	26,5	35	142	3160	4637	2 1/2"	159
SXT 17/53	30	40	142	3490	4970	2 1/2"	186
SXT 17/55	37	50	142	3620	5191	2 1/2"	191

BOMBA TIPO: RADIAL
 TEMP. MAX. LIQUIDO: 30°
 MAX. ARENA: 50 gr/m³
 SENTIDO ROT.: ANTIHORARIO
 VALV. RET.: INCORPORADA

PUMP TYPE: RADIAL
 MAXI. TEMP. LIQUID: 30°
 SAND MAX.: 50 gr/m³
 ROTATION: C.C.W.
 CHECK VAL.: BUILT-IN

POMPE TYPE: RADIALE
 TEMP. MAX. LIQUIDE: 30°
 MAX. SABLE: 50 gr/m³
 SENS. ROT.: ANTIHORAIRE
 CLAPET RET.: INCORPORÉ

Tablas de selección / Selection charts / Tables de selection

Tipo Type	Motor - Moteur		l/min. m ³ /h	Caudal - Capacity - Debit						
	KW	HP		0	120	240	360	480	600	720
SXT 30/4	4	5,5	m.c.a.	45	44	41	37	31	22	11
SXT 30/6	5,5	7,5		67	66	61	55	47	34	17
SXT 30/8	7,5	10		90	87	82	73	63	44	22
SXT 30/11	9,3	12,5		124	120	112	101	86	62	31
SXT 30/13	11	15		146	142	133	119	102	73	43
SXT 30/15	13	17,5		169	164	153	137	118	84	42
SXT 30/17	15	20		192	186	174	156	133	96	48
SXT 30/19	20	25		214	208	194	174	149	107	54
SXT 30/21	20	25		237	229	215	192	165	118	60
SXT 30/23	22	30		259	251	235	211	180	130	65
SXT 30/26	22	30		293	284	266	238	204	147	74
SXT 30/28	26	35		316	306	286	257	220	158	80
SXT 30/30	26	35		339	326	307	277	232	169	85
SXT 30/32	30	40		361	350	327	293	251	181	91
SXT 30/35	30	40		395	382	358	321	275	198	100
SXT 30/39	37	50		440	423	399	360	302	220	111
SXT 30/43	37	50		488	468	440	397	333	243	122
SXT 30/48	45	60	542	522	491	440	372	271	137	

Dimensiones / Dimensions / Dimensions

Materiales tipo A
 Impulsor: AISI 304L
 Difusor: AISI 304L
 Eje: AISI 420
 Camisa AISI 304

Material type A
 Impeller: AISI 304L
 Diffuser: AISI 304L
 Shaft: AISI 420
 Shell: AISI 304

Materiaux type A
 Roue: AISI 304L
 Diffuseur: AISI 304L
 Arbre: AISI 420
 Chemise: AISI 304

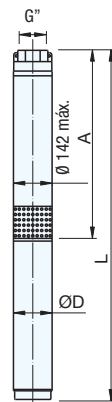

Tipo Type	Motor - Moteur		D mm	A mm	L mm	G"	Peso Weight Poids (kg)
	KW	HP					
SXT 30/4	4	5,5	90	590	1058	3"	55
SXT 30/6	5,5	7,5	90	945	1483	3"	62
SXT 30/8	7,5	10	90	1171	1919	3"	72
SXT 30/11	9,3	12,5	142	1510	2298	3"	81
SXT 30/13	11	15	142	1736	2577	3"	88
SXT 30/15	13	17,5	142	1962	2863	3"	96
SXT 30/17	15	20	142	2188	3151	3"	106
SXT 30/19	20	25	142	2414	3410	3"	117
SXT 30/21	20	25	142	2640	3636	3"	121
SXT 30/23	22	30	142	2866	3962	3"	131
SXT 30/26	22	30	142	3205	4301	3"	135
SXT 30/28	26	35	142	3431	4648	3"	143
SXT 30/30	26	35	142	3657	4874	3"	146
SXT 30/32	30	40	142	3883	5130	3"	163
SXT 30/35	30	40	142	4222	5469	3"	167
SXT 30/39	37	50	142	4674	6011	3"	180
SXT 30/43	37	50	142	5126	6310	3"	186
SXT 30/48	45	60	142	5691	6976	3"	225

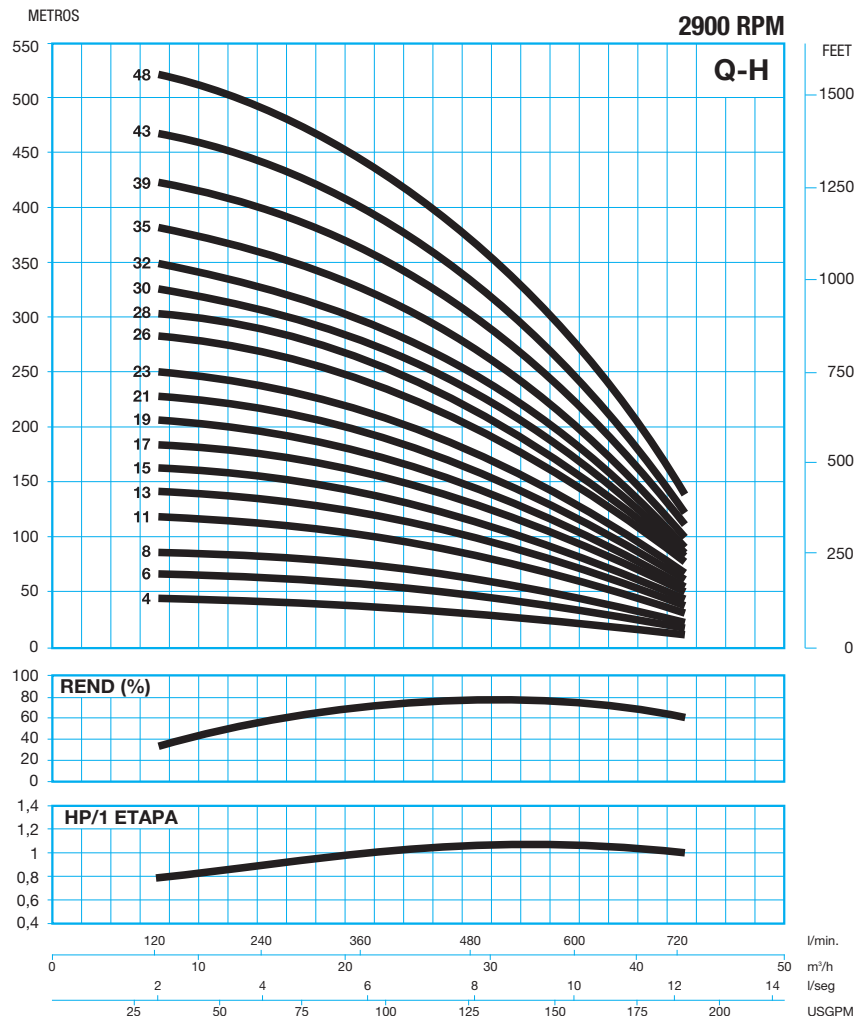

BOMBA TIPO: RADIAL
 TEMP. MAX. LIQUIDO: 30°
 MAX. ARENA: 50 gr/m³
 SENTIDO ROT.: ANTIHORARIO
 VALV. RET.: INCORPORADA

PUMP TYPE: RADIAL
 MAXI. TEMP. LIQUID: 30°
 SAND MAX.: 50 gr/m³
 ROTATION: C.C.W.
 CHECK VAL.: BUILT-IN

POMPE TYPE: RADIALE
 TEMP. MAX. LIQUIDE: 30°
 MAX. SABLE: 50 gr/m³
 SENS. ROT.: ANTIHORAIRE
 CLAPET RET.: INCORPORÉ

Tablas de selección / Selection charts / Tables de selection

Tipo Type	Motor - Moteur		l/min. m ³ /h	Caudal - Capacity - Debit											
	KW	HP		0	315	360	450	540	630	720	810	900	990	1035	1080
				0	18,9	21,6	27	32,4	37,8	43,2	48,6	54	59,4	62,1	64,8
SXT 45/3	5,5	7,5	m.c.a.	46	40	38	35	32	30	28	25	22	17	13	9
SXT 45/5	7,5	10		77	66	64	59	54	50	46	42	37	28	22	15
SXT 45/6	9,3	12,5		92	80	76	70	65	60	56	50	44	33	27	18
SXT 45/7	11	15		107	93	89	82	76	70	65	59	51	39	31	21
SXT 45/8	13	17,5		122	106	102	94	87	80	74	67	58	44	35	24
SXT 45/9	15	20		138	119	115	106	97	90	83	76	66	50	40	27
SXT 45/10	15	20		153	133	127	117	108	100	93	84	73	56	44	30
SXT 45/11	19	25		168	146	140	129	119	110	102	93	80	61	49	32
SXT 45/12	19	25		184	159	153	141	130	120	111	101	88	67	53	35
SXT 45/14	22	30		214	186	178	164	151	140	130	118	102	78	62	41
SXT 45/15	22	30		230	199	191	176	162	150	139	126	110	83	67	44
SXT 45/16	27	35		245	212	204	188	173	160	148	135	117	89	71	47
SXT 45/17	27	35		260	226	217	200	184	170	157	143	124	94	75	50
SXT 45/18	30	40		275	239	229	211	195	180	167	151	131	100	80	53
SXT 45/20	30	40		306	265	255	235	216	200	185	168	146	111	89	59
SXT 45/22	37	50		337	292	280	258	238	220	204	185	161	122	98	65
SXT 45/24	37	50		367	318	306	282	260	240	222	202	175	133	106	71
SXT 45/26	45	60	398	345	331	305	281	261	241	219	190	144	115	77	

Dimensiones / Dimensions / Dimensions

Materiales tipo A
 Impulsor: AISI 304L
 Difusor: AISI 304L
 Eje: AISI 420
 Camisa AISI 304

Material type A
 Impeller: AISI 304L
 Diffuser: AISI 304L
 Shaft: AISI 420
 Shell: AISI 304

Materiaux type A
 Roue: AISI 304L
 Diffuseur: AISI 304L
 Arbre: AISI 420
 Chemise: AISI 304

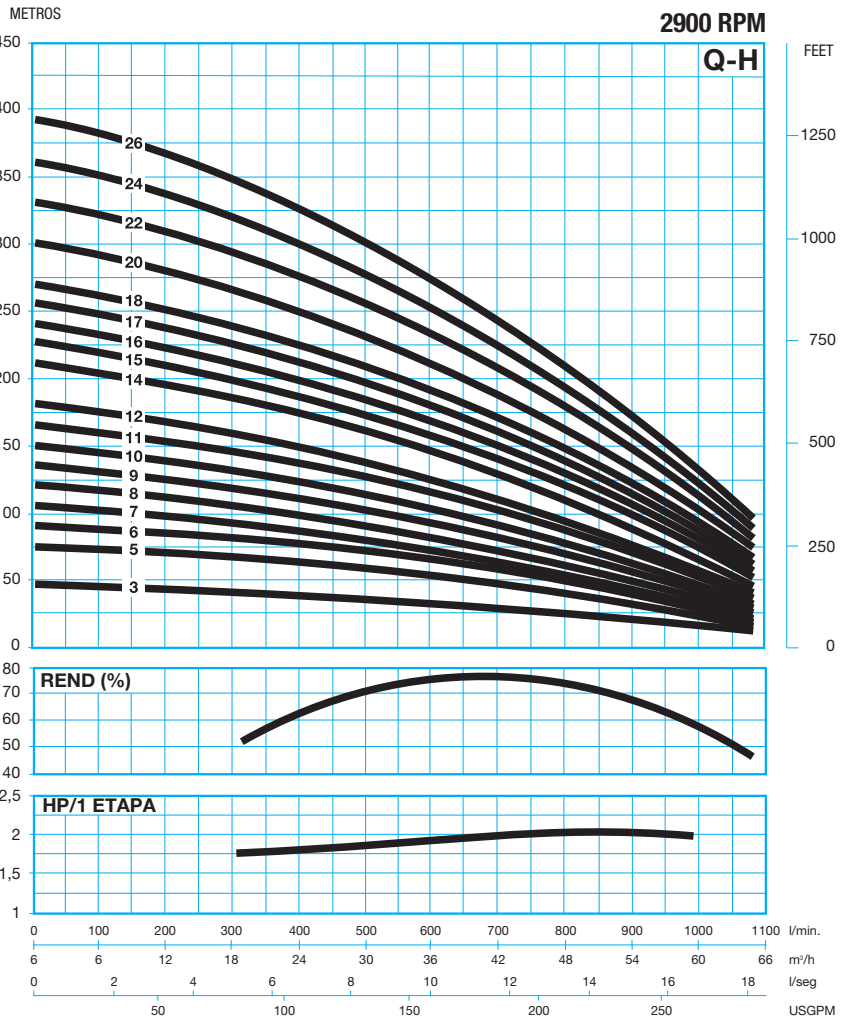
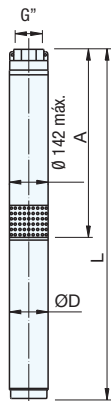

Tipo Type	Motor - Moteur		D mm	A mm	L mm	G"	Peso Weight Poids (kg)
	KW	HP					
SXT 45/3	5,5	7,5	90	590	1268	4"	59
SXT 45/5	7,5	10	144	832	1590	4"	69
SXT 45/6	9,3	12,5	144	945	1745	4"	76
SXT 45/7	11	15	144	1058	1909	4"	82
SXT 45/8	13	17,5	144	1171	2082	4"	89
SXT 45/9	15	20	144	1284	2257	4"	97
SXT 45/10	15	20	144	1397	2370	4"	100
SXT 45/11	19	25	144	1510	2516	4"	110
SXT 45/12	19	25	144	1623	2629	4"	112
SXT 45/14	22	30	144	1845	2955	4"	123
SXT 45/15	22	30	144	1962	3068	4"	125
SXT 45/16	27	35	144	2075	3292	4"	131
SXT 45/17	27	35	144	2188	3405	4"	133
SXT 45/18	30	40	144	2301	3548	4"	150
SXT 45/20	30	40	144	2527	3774	4"	154
SXT 45/22	37	50	144	2753	4100	4"	166
SXT 45/24	37	50	144	2979	4326	4"	173
SXT 45/26	45	60	144	3205	4480	4"	210

BOMBA TIPO: RADIAL
 TEMP. MAX. LIQUIDO: 30°
 MAX. ARENA: 50 gr/m³
 SENTIDO ROT.: ANTIHORARIO
 VALV. RET.: INCORPORADA

PUMP TYPE: RADIAL
 MAXI. TEMP. LIQUID: 30°
 SAND MAX.: 50 gr/m³
 ROTATION: C.C.W.
 CHECK VAL.: BUILT-IN

POMPE TYPE: RADIALE
 TEMP. MAX. LIQUIDE: 30°
 MAX. SABLE: 50 gr/m³
 SENS. ROT.: ANTIHORAIRE
 CLAPET RET.: INCORPORÉ

Tablas de selección / Selection charts / Tables de selection

Tipo Type	Motor - Moteur		l/min. m ³ /h	Caudal - Capacity - Debit						
	KW	HP		0	720	960	1020	1080	1140	1200
SXT 60/2	4	5,5	m.c.a.	28	20	16	15	14	13	11
SXT 60/3	5,5	7,5		40	30	24	23	19	16	13
SXT 60/4	7,5	10		55	40	33	30	26	22	18
SXT 60/5	9,3	12,5		68	48	39	36	32	28	22
SXT 60/6	11	15		81	58	47	43	39	33	27
SXT 60/7	13	17,5		95	67	55	51	45	39	31
SXT 60/8	15	20		109	77	63	58	52	45	36
SXT 60/9	19	25		122	87	71	65	59	50	40
SXT 60/10	19	25		136	96	79	73	65	56	45
SXT 60/11	22	30		150	106	87	80	72	62	49
SXT 60/12	22	30		163	116	94	87	78	67	54
SXT 60/13	26	35		177	126	102	95	85	73	58
SXT 60/15	30	40		204	145	118	109	98	84	68
SXT 60/17	30	40		231	164	134	124	111	96	76
SXT 60/18	37	50		245	174	142	131	118	101	81
SXT 60/19	37	50		259	184	150	138	124	107	85
SXT 60/20	37	50		272	193	158	146	131	113	90
SXT 60/21	37	50		286	203	166	153	137	118	94

Dimensiones / Dimensions / Dimensions

Materiales tipo A
 Impulsor: AISI 304L
 Difusor: AISI 304L
 Eje: AISI 420
 Camisa AISI 304

Material type A
 Impeller: AISI 304L
 Diffuser: AISI 304L
 Shaft: AISI 420
 Shell: AISI 304

Materiaux type A
 Roue: AISI 304L
 Diffuseur: AISI 304L
 Arbre: AISI 420
 Chemise: AISI 304

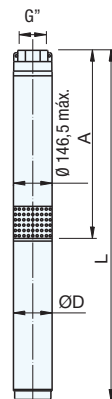

Tipo Type	Motor - Moteur		D mm	A mm	L mm	G" mm	Peso Weight Poids (kg)
	KW	HP					
SXT 60/2	4	5,5	90	477	945	4"	54
SXT 60/3	5,5	7,5	90	606	1144	4"	59
SXT 60/4	7,5	10	142	719	1467	4"	67
SXT 60/5	9,3	12,5	142	832	1620	4"	73
SXT 60/6	11	15	142	945	1786	4"	79
SXT 60/7	13	17,5	142	1058	1959	4"	86
SXT 60/8	15	20	142	1171	2134	4"	95
SXT 60/9	19	25	142	1284	2290	4"	105
SXT 60/10	19	25	142	1397	2393	4"	107
SXT 60/11	22	30	142	1510	2616	4"	116
SXT 60/12	22	30	142	1623	2719	4"	118
SXT 60/13	26	35	142	1736	2953	4"	125
SXT 60/15	30	40	142	1849	3066	4"	144
SXT 60/17	30	40	142	2188	3425	4"	149
SXT 60/18	37	50	142	2301	3648	4"	158
SXT 60/19	37	50	142	2414	3761	4"	160
SXT 60/20	37	50	142	2527	3874	4"	162
SXT 60/21	37	50	142	2640	3977	4"	164

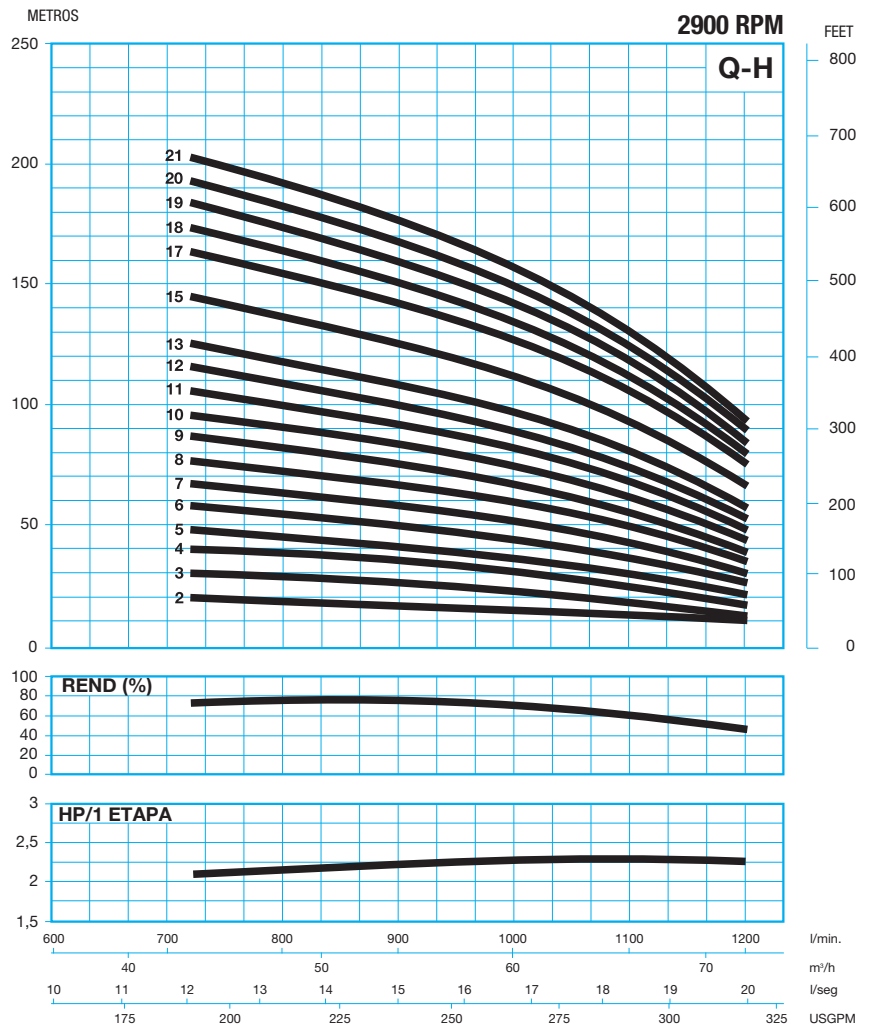

BOMBA TIPO: RADIAL
 TEMP. MAX. LIQUIDO: 30°
 MAX. ARENA: 50 gr/m³
 SENTIDO ROT.: ANTIHORARIO
 VALV. RET.: INCORPORADA

PUMP TYPE: RADIAL
 MAXI. TEMP. LIQUID: 30°
 SAND MAX.: 50 gr/m³
 ROTATION: C.C.W.
 CHECK VAL.: BUILT-IN

POMPE TYPE: RADIALE
 TEMP. MAX. LIQUIDE: 30°
 MAX. SABLE: 50 gr/m³
 SENS. ROT.: ANTIHORAIRE
 CLAPET RET.: INCORPORÉ

Tablas de selección / Selection charts / Tables de selection

Tipo Type	Motor - Moteur		l/min. m ³ /h	Caudal - Capacity - Debit											
	KW	HP		0	300	450	600	750	900	1050	1200	1350	1500	1650	1800
SXT 75/1	4	5,5	m.c.a.	20	19	19	18	17	16	15	14	13	11	9	6
SXT 75/2	7,5	10		39	38	37	36	34	32	30	28	25	22	18	13
SXT 75/3	11	15		59	57	56	54	51	49	45	42	38	33	27	19
SXT 75/4	15	20		78	76	74	71	68	65	61	56	50	43	35	25
SXT 75/5	19	25		98	95	93	89	85	81	76	70	63	54	44	32
SXT 75/6	22	30		118	114	111	107	102	97	91	84	75	65	53	38
SXT 75/7	27	35		137	133	130	125	119	113	106	98	88	76	62	45
SXT 75/8	30	40		157	152	148	143	136	129	121	112	100	87	71	51
SXT 75/10	37	50		196	191	185	179	171	162	151	140	125	109	89	64
SXT 75/12	45	60		235	229	222	214	205	194	182	167	150	130	106	76
SXT 75/14	52	70		275	267	259	250	239	226	212	195	175	152	124	89
SXT 75/15	55	75		294	286	278	268	256	243	227	209	188	163	133	96
SXT 75/16	60	80		314	305	296	286	273	259	242	223	200	174	142	102
SXT 75/17	67	90		333	324	315	304	290	275	257	237	213	184	150	108
SXT 75/19	75	100		373	362	352	339	324	307	288	265	238	206	168	121
SXT 75/21	81	110		412	400	389	375	358	340	318	293	263	228	186	134
SXT 75/22	81	110		431	419	407	393	375	356	333	307	275	239	195	140
SXT 75/24	92	125		471	457	444	429	409	388	363	335	300	260	212	153

Dimensiones / Dimensions / Dimensions

Materiales tipo A
 Impulsor: AISI 304L
 Difusor: AISI 304L
 Eje: AISI 420
 Camisa AISI 304

Material type A
 Impeller: AISI 304L
 Diffuser: AISI 304L
 Shaft: AISI 420
 Shell: AISI 304

Materiaux type A
 Roue: AISI 304L
 Diffuseur: AISI 304L
 Arbre: AISI 420
 Chemise: AISI 304

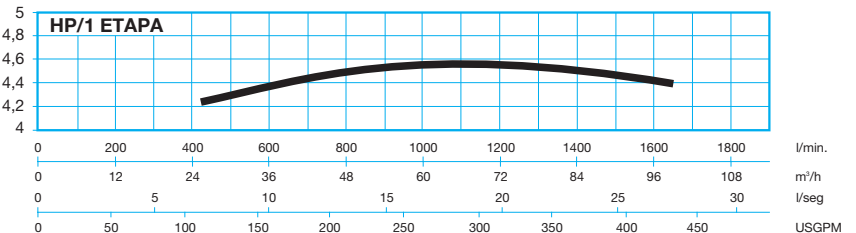
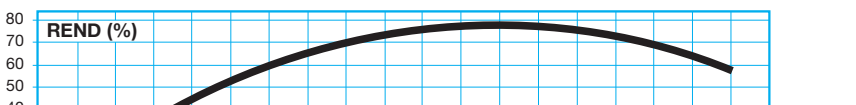
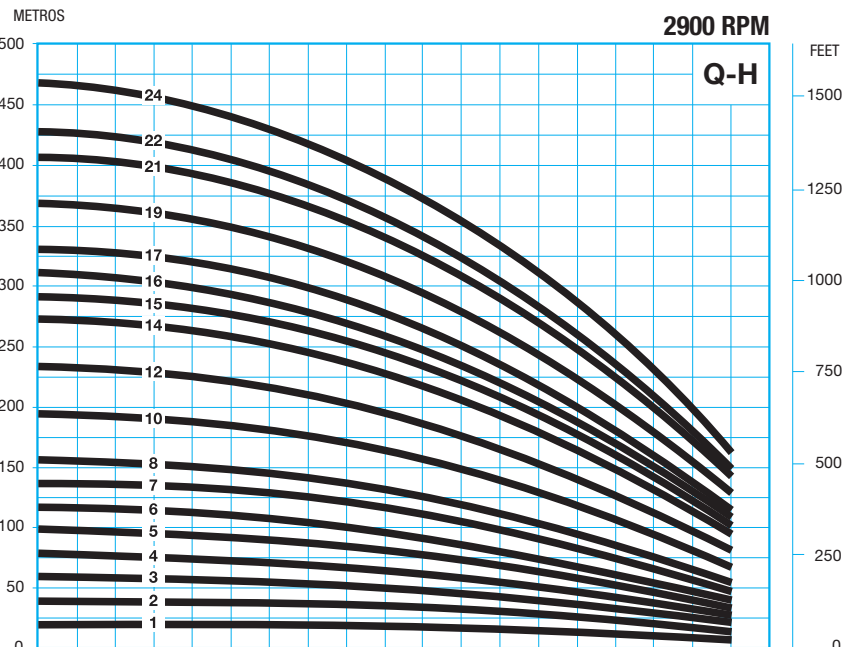
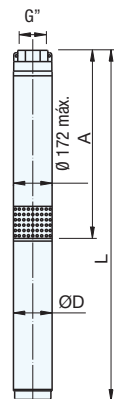

Tipo Type	Motor - Moteur		D mm	A mm	L mm	G"	Peso Weight Poids (kg)
	KW	HP					
SXT 75/1	4	5,5	142	571	1220	5"	70
SXT 75/2	7,5	10	142	699	1457	5"	83
SXT 75/3	11	15	142	827	1678	5"	95
SXT 75/4	15	20	142	955	1928	5"	110
SXT 75/5	19	25	142	1083	2089	5"	122
SXT 75/6	22	30	142	1211	2317	5"	132
SXT 75/7	27	35	142	1339	2556	5"	140
SXT 75/8	30	40	142	1467	2523	5"	161
SXT 75/10	37	50	142	1723	2839	5"	195
SXT 75/12	45	60	192	1979	3180	5"	210
SXT 75/14	52	70	192	2235	3521	5"	224
SXT 75/15	55	75	192	2363	3649	5"	234
SXT 75/16	60	80	192	2491	3832	5"	246
SXT 75/17	67	90	192	2619	3985	5"	258
SXT 75/19	75	100	192	2875	4266	5"	287
SXT 75/21	81	110	192	3131	4602	5"	302
SXT 75/22	81	110	192	3259	4730	5"	306
SXT 75/24	92	125	192	3439	4975	5"	319

BOMBA TIPO: RADIAL
 TEMP. MAX. LIQUIDO: 30°
 MAX. ARENA: 50 gr/m³
 SENTIDO ROT.: ANTIHORARIO
 VALV. RET.: INCORPORADA

PUMP TYPE: RADIAL
 MAXI. TEMP. LIQUID: 30°
 SAND MAX.: 50 gr/m³
 ROTATION: C.C.W.
 CHECK VAL.: BUILT-IN

POMPE TYPE: RADIALE
 TEMP. MAX. LIQUIDE: 30°
 MAX. SABLE: 50 gr/m³
 SENS. ROT.: ANTIHORAIRE
 CLAPET RET.: INCORPORÉ

Tablas de selección / Selection charts / Tables de selection

Tipo Type	Motor - Moteur		l/min. m ³ /h	Caudal - Capacity - Debit								
	KW	HP		0	336	666	1002	1164	1332	1500	1668	1836
SXT 95/1	5,5	7,5	m.c.a.	25	24	21	19	18	17	16	15	13
SXT 95/2	11	15		49	46	41	36	34	33	32	28	25
SXT 95/3	15	20		74	70	62	55	52	50	47	43	37
SXT 95/4	22	30		98	93	82	74	70	66	63	57	50
SXT 95/5	30	40		123	117	103	91	87	82	77	72	62
SXT 95/6	37	50		147	139	123	110	104	99	93	86	74
SXT 95/7	37	50		172	163	145	128	122	116	109	100	87
SXT 95/8	45	60		196	186	166	146	139	132	124	115	99
SXT 95/9	45	60		221	210	186	165	156	149	140	128	112
SXT 95/10	55	75		245	232	207	183	173	165	156	143	124
SXT 95/11	60	80		270	256	227	201	191	181	172	158	136
SXT 95/12	67	90		294	279	248	220	209	198	187	172	149
SXT 95/13	75	100		319	303	269	238	225	215	202	186	162
SXT 95/14	75	100		343	325	289	256	243	231	218	200	173
SXT 95/15	81	110		368	349	310	274	261	248	233	215	186
SXT 95/17	92	125		417	396	351	311	295	280	265	243	211
SXT 95/18	110	150		441	418	371	329	313	297	280	258	223
SXT 95/20	110	150		490	466	414	366	347	330	312	286	248

Dimensiones / Dimensions / Dimensions

Materiales tipo A
 Impulsor: AISI 304L
 Difusor: AISI 304L
 Eje: AISI 420
 Camisa AISI 304

Material type A
 Impeller: AISI 304L
 Diffuser: AISI 304L
 Shaft: AISI 420
 Shell: AISI 304

Materiaux type A
 Roue: AISI 304L
 Diffuseur: AISI 304L
 Arbre: AISI 420
 Chemise: AISI 304

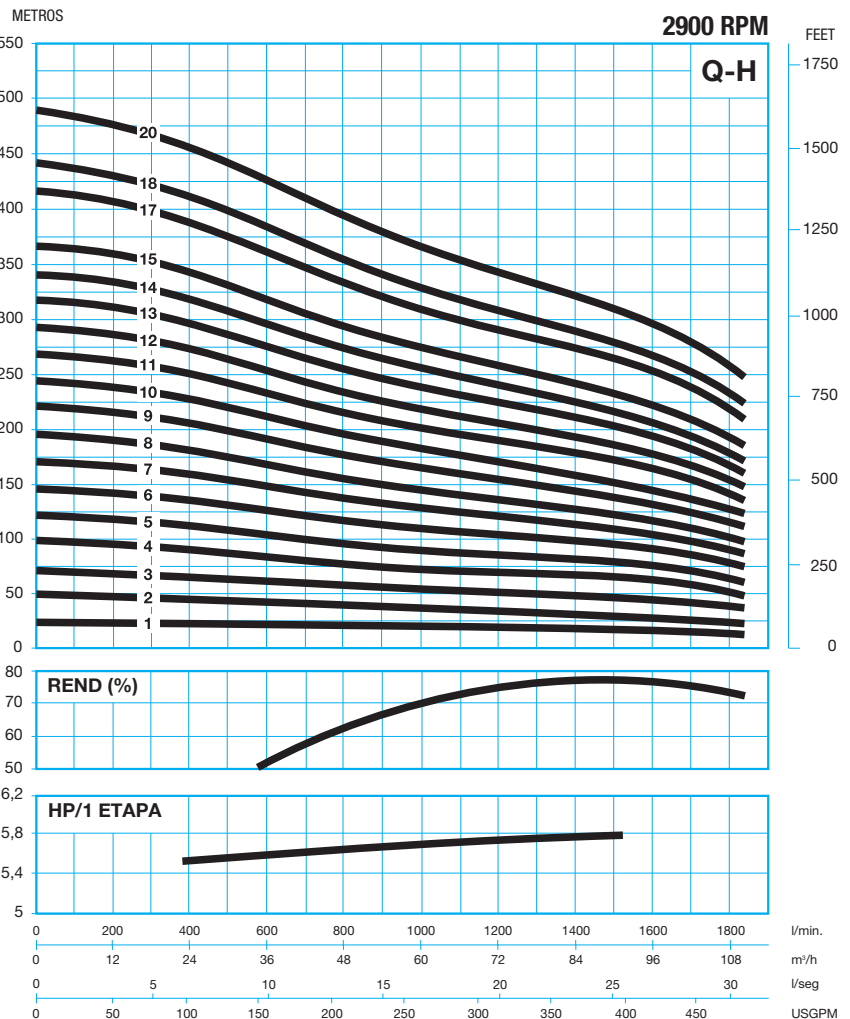
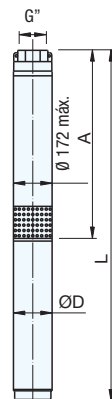

Tipo Type	Motor - Moteur		D mm	A mm	L mm	G"	Peso Weight Poids (kg)
	KW	HP					
SXT 95/1	5,5	7,5	142	607	1350	5"	69
SXT 95/2	11	15	142	672	1458	5"	115
SXT 95/3	15	20	142	735	1708	5"	138
SXT 95/4	22	30	142	863	1969	5"	154
SXT 95/5	30	40	142	991	2047	5"	166
SXT 95/6	37	50	142	1119	2235	5"	190
SXT 95/7	37	50	142	1247	2363	5"	205
SXT 95/8	45	60	192	1375	2576	5"	213
SXT 95/9	45	60	192	1519	2720	5"	248
SXT 95/10	55	75	192	1647	2933	5"	258
SXT 95/11	60	80	192	1775	3116	5"	272
SXT 95/12	67	90	192	1903	3269	5"	284
SXT 95/13	75	100	192	2031	3422	5"	300
SXT 95/14	75	100	192	2159	3550	5"	317
SXT 95/15	81	110	192	2287	3987	5"	346
SXT 95/17	92	125	192	2543	4079	5"	421
SXT 95/18	110	150	231	2761	4181	5"	431
SXT 95/20	110	150	231	2927	4437	5"	548

BOMBA TIPO: RADIAL
 TEMP. MAX. LIQUIDO: 30°
 MAX. ARENA: 50 gr/m³
 SENTIDO ROT.: ANTIHORARIO
 VALV. RET.: INCORPORADA

PUMP TYPE: RADIAL
 MAXI. TEMP. LIQUID: 30°
 SAND MAX.: 50 gr/m³
 ROTATION: C.C.W.
 CHECK VAL.: BUILT-IN

POMPE TYPE: RADIALE
 TEMP. MAX. LIQUIDE: 30°
 MAX. SABLE: 50 gr/m³
 SENS. ROT.: ANTIHORAIRE
 CLAPET RET.: INCORPORÉ

Tablas de selección / Selection charts / Tables de selection

Tipo Type	Motor - Moteur		l/min. m ³ /h	Caudal - Capacity - Debit											
	KW	HP		0	600	960	1200	1560	1680	1800	1920	2160	2400	2640	2880
SXT 125/1	11	15	m.c.a.	31	30	28	27	25	25	24	24	22	19	17	13
SXT 125/2	22	30		63	60	57	55	51	49	48	46	42	38	32	25
SXT 125/3	37	50		94	89	85	81	76	74	72	70	64	57	49	39
SXT 125/4	45	60		125	120	114	109	102	99	95	92	85	75	65	52
SXT 125/5	55	75		157	149	142	136	126	123	120	116	106	95	81	65
SXT 125/6	67	90		188	179	171	164	152	148	143	138	127	114	98	77
SXT 125/7	75	100		221	209	198	191	177	172	168	162	149	133	114	90
SXT 125/8	93	125		252	238	226	218	203	197	191	184	170	152	130	104
SXT 125/9	110	150		283	269	255	245	228	221	215	208	191	171	147	117
SXT 125/10	110	150		315	298	283	272	254	246	239	231	213	190	163	129
SXT 125/11	129	175		346	328	312	300	279	271	263	254	233	209	178	142
SXT 125/12	129	175		377	358	340	327	304	296	287	277	255	228	195	155
SXT 125/13	147	200		409	387	368	354	330	320	311	300	276	247	212	169

Dimensiones / Dimensions / Dimensions

Materiales tipo A
 Impulsor: AISI 304L
 Difusor: AISI 304L
 Eje: AISI 420
 Camisa AISI 304

Material type A
 Impeller: AISI 304L
 Diffuser: AISI 304L
 Shaft: AISI 420
 Shell: AISI 304

Materiaux type A
 Roue: AISI 304L
 Diffuseur: AISI 304L
 Arbre: AISI 420
 Chemise: AISI 304

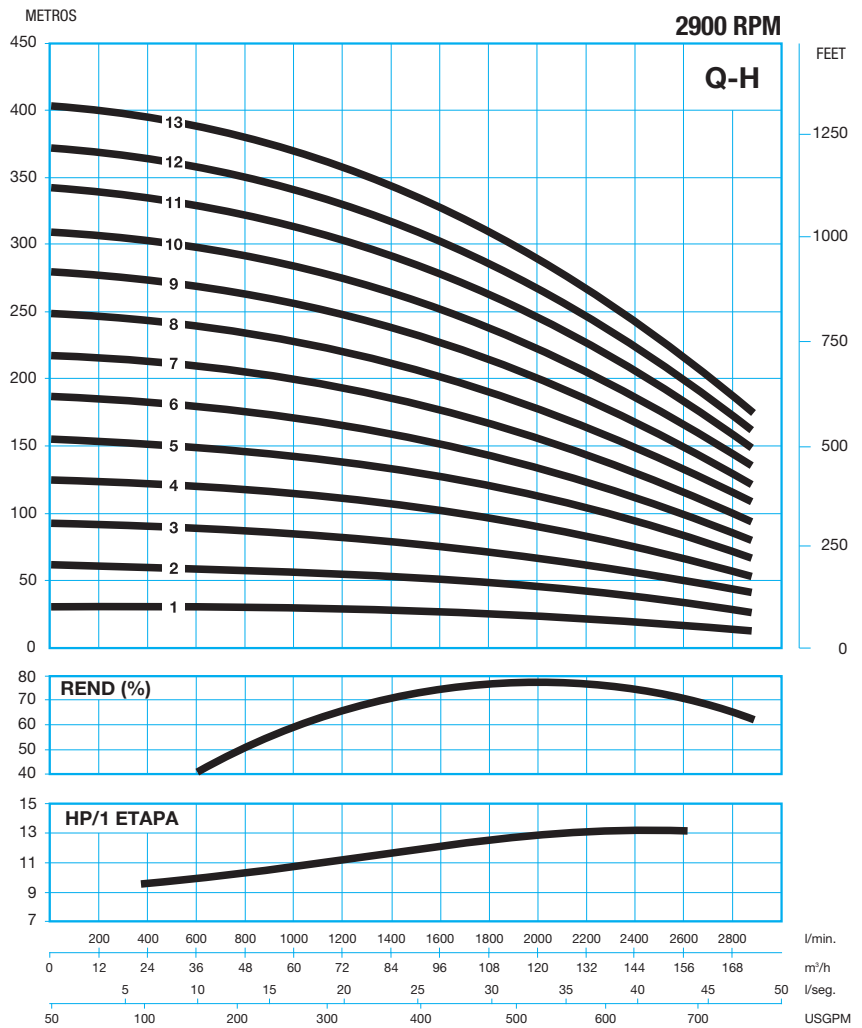
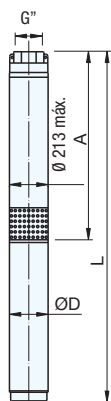

Tipo Type	Motor - Moteur		D mm	A mm	L mm	G" mm	Peso Weight Poids (kg)
	KW	HP					
SXT 125/1	11	15	142	686	1537	6"	93
SXT 125/2	22	30	142	842	1948	6"	125
SXT 125/3	37	50	142	997	2113	6"	183
SXT 125/4	45	60	192	1153	2354	6"	204
SXT 125/5	55	75	192	1309	2595	6"	228
SXT 125/6	67	90	192	1465	2831	6"	251
SXT 125/7	75	100	192	1620	3011	6"	266
SXT 125/8	93	125	192	1776	3312	6"	290
SXT 125/9	110	150	231	1932	3442	6"	395
SXT 125/10	110	150	231	2087	3597	6"	402
SXT 125/11	129	175	231	2243	3853	6"	435
SXT 125/12	129	175	231	2399	4009	6"	442
SXT 125/13	147	200	231	2554	4294	6"	480

BOMBA TIPO: RADIAL
 TEMP. MAX. LIQUIDO: 30°
 MAX. ARENA: 50 gr/m³
 SENTIDO ROT.: ANTIHORARIO
 VALV. RET.: INCORPORADA

PUMP TYPE: RADIAL
 MAXI. TEMP. LIQUID: 30°
 SAND MAX.: 50 gr/m³
 ROTATION: C.C.W.
 CHECK VAL.: BUILT-IN

POMPE TYPE: RADIALE
 TEMP. MAX. LIQUIDE: 30°
 MAX. SABLE: 50 gr/m³
 SENS. ROT.: ANTIHORAIRE
 CLAPET RET.: INCORPORÉ

Tablas de selección / Selection charts / Tables de selection

Tipo Type	Motor - Moteur		l/min. m ³ /h	Caudal - Capacity - Debit						
	KW	HP		1333	1667	2000	2333	2666	3000	3334
SXT 160/1	11	15	m.c.a.	25	24	22	21	19	16	13
SXT 160/2B	18,5	25		39	37	34	32	29	25	20
SXT 160/2A	22	30		51	48	45	41	38	33	26
SXT 160/3B	30	40		65	61	58	53	49	42	34
SXT 160/3A	37	50		76	72	67	62	57	49	40
SXT 160/4	45	60		101	96	89	83	75	66	53
SXT 160/5	55	75		127	119	112	104	94	82	66
SXT 160/6B	60	80		137	129	121	112	102	89	71
SXT 160/6A	67	90		152	143	134	124	113	99	79
SXT 160/7B	75	100		165	155	145	135	123	107	86
SXT 160/7A	83	110		175	167	157	145	132	115	92
SXT 160/8	93	125		203	191	179	166	151	132	106
SXT 160/9	110	150		228	215	201	187	170	148	119
SXT 160/10	110	150	254	239	224	207	189	165	132	
SXT 160/11	130	175	279	263	246	228	207	181	145	
SXT 160/12	150	200	304	287	268	249	226	197	158	
SXT 160/13	150	200	330	310	291	270	245	214	172	

Dimensiones / Dimensions / Dimensions

Materiales tipo A
 Impulsor: AISI 304L
 Difusor: AISI 304L
 Eje: AISI 420
 Camisa AISI 304

Material type A
 Impeller: AISI 304L
 Diffuser: AISI 304L
 Shaft: AISI 420
 Shell: AISI 304

Materiaux type A
 Roue: AISI 304L
 Diffuseur: AISI 304L
 Arbre: AISI 420
 Chemise: AISI 304

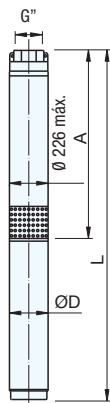

Tipo Type	Motor - Moteur		D mm	A mm	L mm	G"	Peso Weight Poids (kg)
	KW	HP					
SXT 160/1	11	15	142	700	1667	6"	104
SXT 160/2B	18,5	25	142	850	1856	6"	124
SXT 160/2A	22	30	142	850	1946	6"	130
SXT 160/3B	30	40	192	1000	2237	6"	177
SXT 160/3A	37	50	192	1000	2337	6"	185
SXT 160/4	45	60	192	1150	2334	6"	196
SXT 160/5	55	75	192	1300	2569	6"	214
SXT 160/6B	60	80	192	1450	2816	6"	228
SXT 160/6A	67	90	192	1450	2841	6"	237
SXT 160/7B	75	100	192	1600	3071	6"	264
SXT 160/7A	83	110	192	1600	2954	6"	271
SXT 160/8	93	125	192	1750	3164	6"	288
SXT 160/9	110	150	231	1900	3410	6"	385
SXT 160/10	110	150	231	2050	3560	6"	391
SXT 160/11	130	175	231	2200	3810	6"	426
SXT 160/12	150	200	231	2350	4090	6"	472
SXT 160/13	150	200	231	2500	4240	6"	478

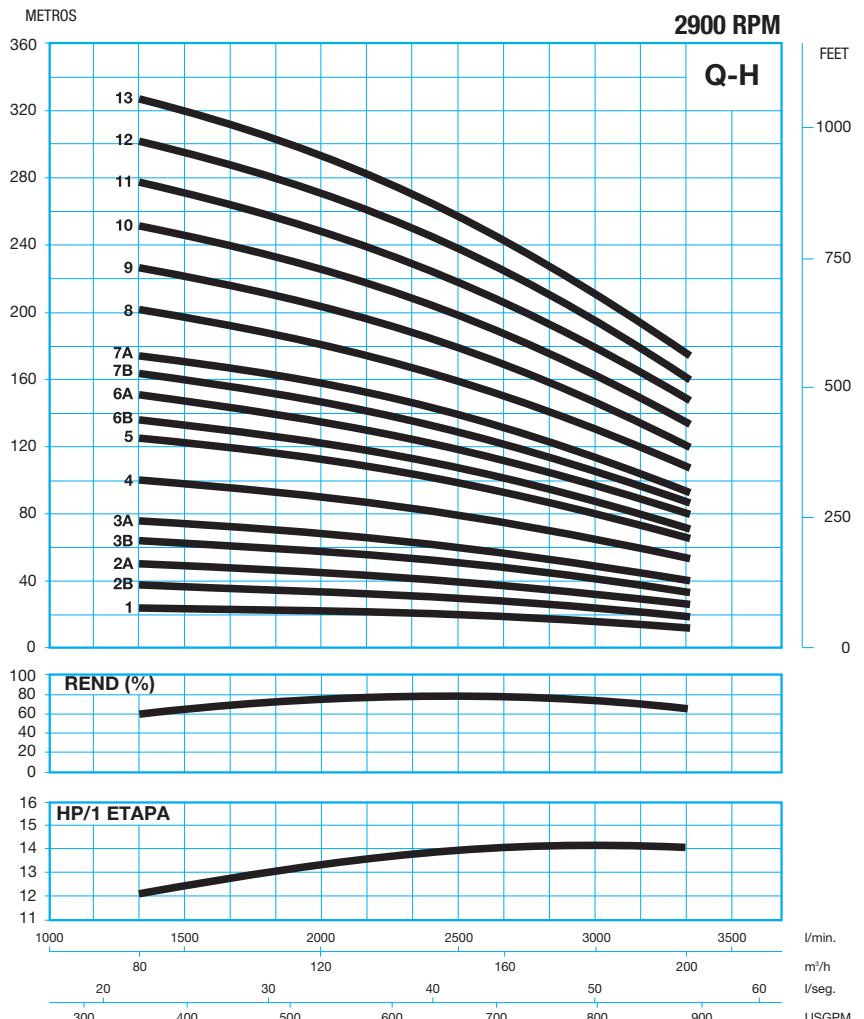

BOMBA TIPO: SEMIAXIAL
 TEMP. MAX. LIQUIDO: 25°
 MAX. ARENA: 40 gr/m³
 SENTIDO ROT.: ANTIHORARIO
 VALV. RET.: INCORPORADA

PUMP TYPE: MIXED FLOW
 MAXI. TEMP. LIQUID: 25°
 SAND MAX.: 40 gr/m³
 ROTATION: C.C.W.
 CHECK VAL.: BUILT IN

POMPE TYPE: SEMIAXIAL
 TEMP. MAX. LIQUIDE: 25°
 MAX. SABLE: 40 gr/m³
 SENS. ROT.: ANTIHORAIRE
 CLAPET RET.: INCORPORÉ

Tablas de selección / Selection charts / Tables de selection

Tipo Type	Motor - Moteur		l/min. m³/h	Caudal - Capacity - Debit					
	KW	HP		0	200	300	400	500	550
SD 0,30-3	3	4	m.c.a.	40	36	33	28	22	17
SD 0,30-4	4	5,5		53	48	43	37	29	23
SD 0,30-6	5,5	7,5		80	73	65	56	43	35
SD 0,30-8	7,5	10		106	97	87	74	58	46
SD 0,30-10	9,2	12,5		133	121	109	93	72	58
SD 0,30-12	11	15		159	145	130	111	86	70
SD 0,30-16	15	20		212	194	174	148	115	93
SD 0,30-18	18,5	25		239	218	196	167	130	104
SD 0,30-20	18,5	25		265	242	217	185	144	116
SD 0,30-22	22	30		292	267	239	204	158	128

Dimensiones / Dimensions / Dimensions

Materiales tipo A
 Impulsor: Hierro fundido
 Cuerpo: Hierro fundido
 Eje: Acero inox.

Material type A
 Impeller: Cast iron
 Bowl: Cast iron
 Shaft: St. steel

Materiaux type A
 Roue: Fonte
 Corps: Fonte
 Arbre: Acier inox.

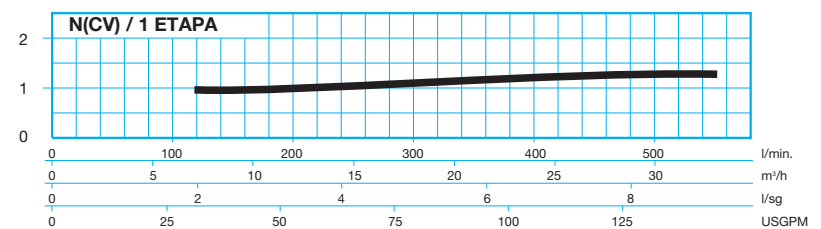
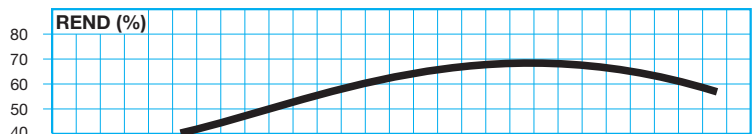
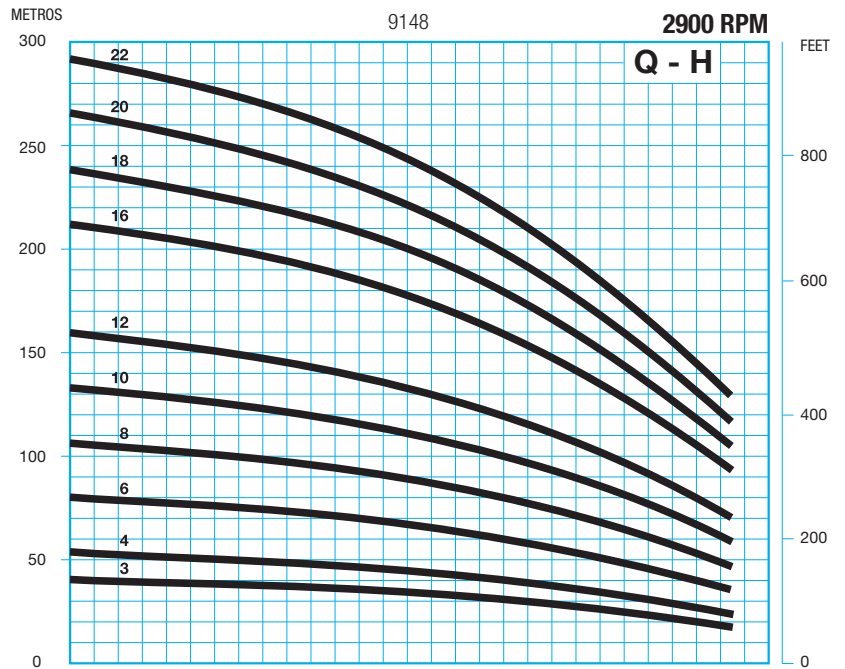
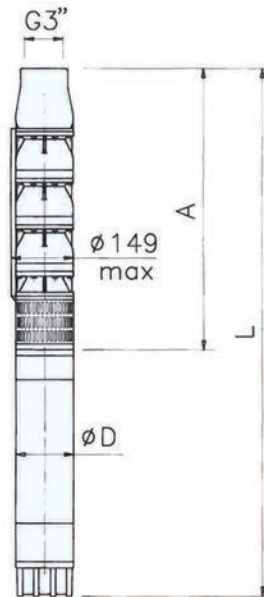

Tipo Type	Motor - Moteur		D mm	A mm	L mm	Peso Weight Poids (kg)
	KW	HP				
SD 0,30-3	3	4	90	690	1113	45
SD 0,30-4	4	5,5	90	805	1388	59
SD 0,30-6	5,5	7,5	90	1035	1733	77
SD 0,30-8	7,5	10	140	1265	1911	104
SD 0,30-10	9,2	12,5	140	1495	2173	119
SD 0,30-12	11	15	140	1725	2436	134
SD 0,30-16	15	20	140	2185	2961	164
SD 0,30-18	18,5	25	140	2415	3256	182
SD 0,30-20	18,5	25	140	2645	3486	194
SD 0,30-22	22	30	140	2875	3781	212

BOMBA TIPO: SEMIAXIAL
 TEMP. MAX. LIQUIDO: 25°
 MAX. ARENA: 40 gr/m³
 SENTIDO ROT.: ANTIHORARIO
 VALV. RET.: INCORPORADA

PUMP TYPE: MIXED FLOW
 MAXI. TEMP. LIQUID: 25°
 SAND MAX.: 40 gr/m³
 ROTATION: C.C.W.
 CHECK VAL.: BUILT-IN

POMPE TYPE: SEMIAXIAL
 TEMP. MAX. LIQUIDE: 25°
 MAX. SABLE: 40 gr/m³
 SENS. ROT.: ANTIHORAIRE
 CLAPET RET.: INCORPORÉ

Tablas de selección / Selection charts / Tables de selection

Tipo Type	Motor - Moteur		l/min. m ³ /h	Caudal - Capacity - Debit					
	KW	HP		0	400	500	550	600	700
SD 0,36 - 2 F2E	2,2	3	m.c.a.	24	19	17	16	14	7
SD 0,36 - 2	3	4		28	23	21	19	17	12
SD 0,36 - 3	4	5,5		42	34	31	29	26	24
SD 0,36 - 5 F5	5,5	7,5		64	52	48	44	38	26
SD 0,36 - 6 F1	7,5	10		81	67	63	58	51	35
SD 0,36 - 7	9,2	12,5		96	80	73,5	68	61	42
SD 0,36 - 9 F4	11	15		119	98	92	83	74	50
SD 0,36 - 10	13	17,5		138	114	105	97	87	60
SD 0,36 - 12 F4	15	20		160	131	124	113	100	68
SD 0,36 - 14	18,5	25		194	158	147	136	122	83
SD 0,36 - 17	22	30		235	192	179	166	148	102
SD 0,36 - 19	25	35		263	215	200	185	166	114
SD 0,36 - 22	30	40	304	250	231	213	190	135	

Dimensiones / Dimensions / Dimensions

Materiales tipo A
 Impulsor: Hierro fundido
 Cuerpo: Hierro fundido
 Eje: Acero inox.

Material type A
 Impeller: Cast iron
 Bowl: Cast iron
 Shaft: St. steel

Materiaux type A
 Roue: Fonte
 Corps: Fonte
 Arbre: Acier inox.

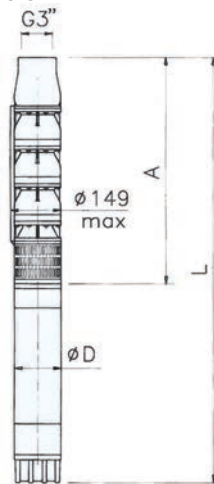

Tipo Type	Motor - Moteur		D mm	A mm	L mm	Peso Weight Poids (kg)
	KW	HP				
SD 0,36-2 F2E	2,2	3	90	545	901	42
SD 0,36-2	3	4	90	545	968	44
SD 0,36-3	4	5,5	90	660	1250	57
SD 0,36-5 F5	5,5	7,5	90	890	1594	72
SD 0,36-6 F1	7,5	10	140	1035	1671	89
SD 0,36-7	9,2	12,5	140	1150	1818	98
SD 0,36-9 F4	11	15	140	1380	2081	111
SD 0,36-10	13	17,5	140	1495	2261	122
SD 0,36-12 F4	15	20	140	1725	2491	132
SD 0,36-14	18,5	25	140	1955	2786	149
SD 0,36-17	22	30	140	2300	3196	170
SD 0,36-19	25	35	140	2530	3556	193
SD 0,36-22	30	40	140	2875	3901	208

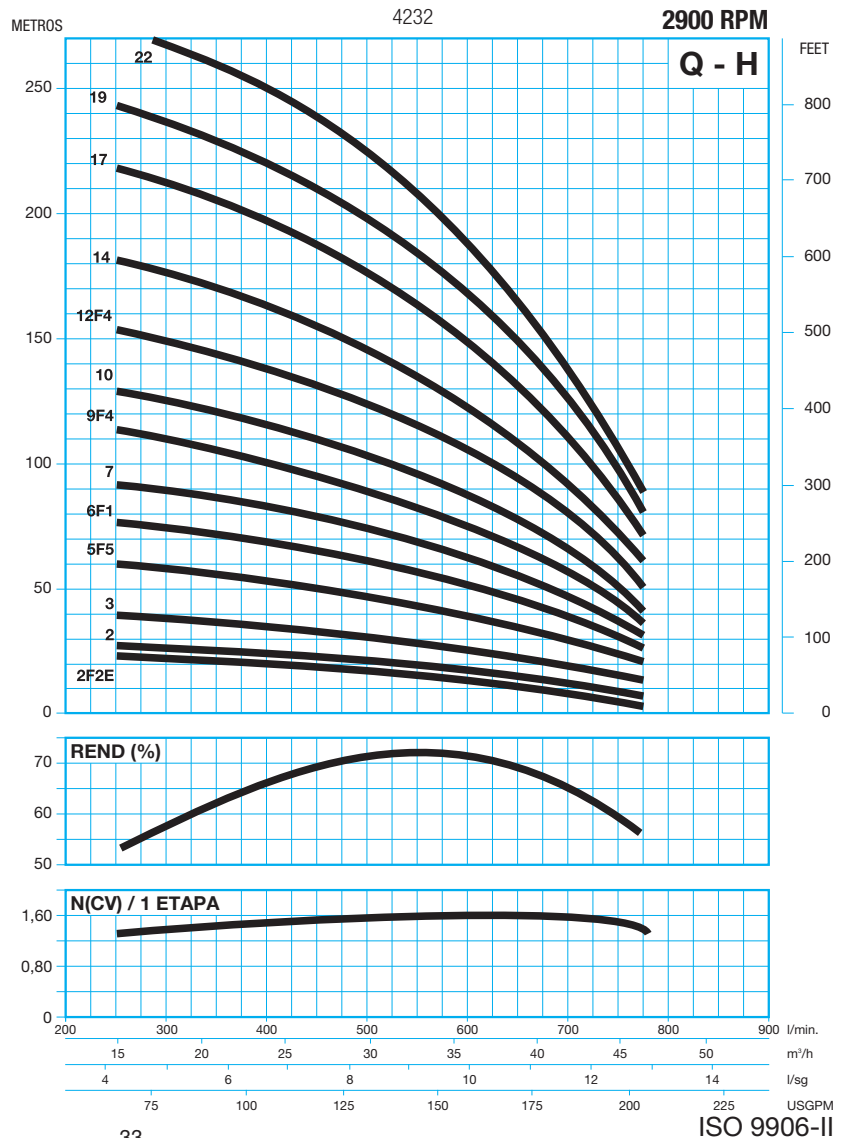

50Hz

BOMBA TIPO: SEMIAXIAL
 TEMP. MAX. LIQUIDO: 25°
 MAX. ARENA: 40 gr/m³
 SENTIDO ROT.: ANTIHORARIO
 VALV. RET.: INCORPORADA

PUMP TYPE: MIXED FLOW
 MAXI. TEMP. LIQUID: 25°
 SAND MAX.: 40 gr/m³
 ROTATION: C.C.W.
 CHECK VAL.: BUILT-IN

POMPE TYPE: SEMIAXIAL
 TEMP. MAX. LIQUIDE: 25°
 MAX. SABLE: 40 gr/m³
 SENS. ROT.: ANTIHORAIRE
 CLAPET RET.: INCORPORÉ

Tablas de selección / Selection charts / Tables de selection

Tipo Type	Motor - Moteur		l/min. m ³ /h	Caudal - Capacity - Debit					
	KW	HP		0	500	600	700	900	1000
				0	30	36	42	54	60
SD 0,42 - 2 F2E	3	4	m.c.a.	25	23	20	17	10	5
SD 0,42 - 2	4	5,5		34	28	25	23	18	14
SD 0,42 - 3 F1	5,5	7,5		48	39	36	32	24	18
SD 0,42 - 4 F1	7,5	10		64	53	49	43	33	25
SD 0,42 - 5 F2	9,2	12,5		78	65	59	53	40	29
SD 0,42 - 6 F2	11	15		94	79	72	64	49	36
SD 0,42 - 7 F3	13	17,5		107	90	83	73	55	40
SD 0,42 - 8 F4	15	20		121	102	93	83	62	45
SD 0,42 - 9	18,5	25		145	124	114	102	80	62
SD 0,42 - 11	22	30		178	151	139	125	98	76
SD 0,42 - 13 F2	25	35		208	177	162	145	114	87
SD 0,42 - 15 F1	30	40		238	202	186	166	129	99
SD 0,42 - 18	37	50		290	248	228	204	161	123

Dimensiones / Dimensions / Dimensions

Materiales tipo A
 Impulsor: Hierro fundido
 Cuerpo: Hierro fundido
 Eje: Acero inox.

Material type A
 Impeller: Cast iron
 Bowl: Cast iron
 Shaft: St. steel

Materiaux type A
 Roue: Fonte
 Corps: Fonte
 Arbre: Acier inox.

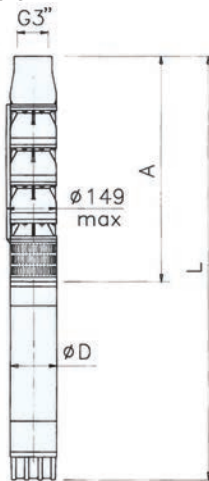

Tipo Type	Motor - Moteur		D mm	A mm	L mm	Peso Weight Poids (kg)
	KW	HP				
SD 0,42-2 F2E	3	4	90	545	968	43
SD 0,42-2	4	5,5	90	545	1135	51
SD 0,42-3 F1	5,5	7,5	90	660	1364	61
SD 0,42-4 F1	7,5	10	140	805	1441	79
SD 0,42-5 F2	9,2	12,5	140	920	1588	88
SD 0,42-6 F2	11	15	140	1035	1736	102
SD 0,42-7 F3	13	17,5	140	1150	1916	107
SD 0,42-8 F4	15	20	140	1265	2031	112
SD 0,42-9	18,5	25	140	1380	2211	124
SD 0,42-11	22	30	140	1610	2506	140
SD 0,42-13 F2	25	35	140	1840	2866	163
SD 0,42-15 F1	30	40	140	2070	3096	173
SD 0,42-18	37	50	140	2415	3884	228

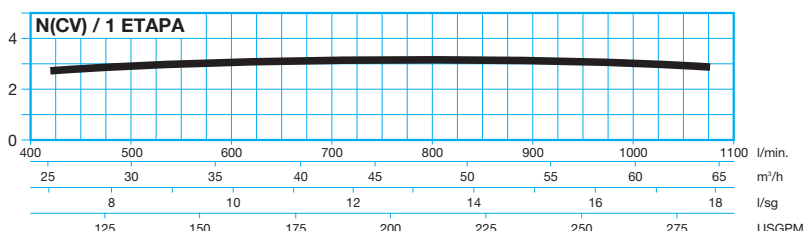
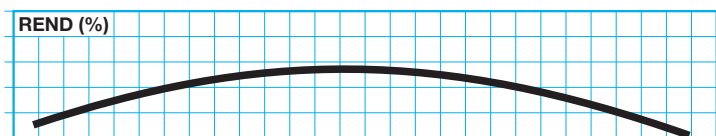
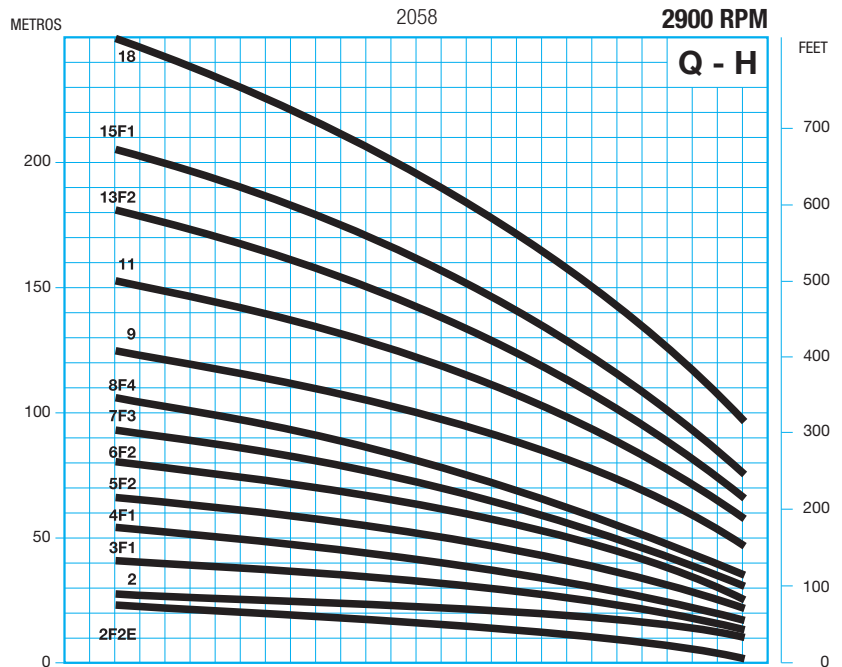

BOMBA TIPO: SEMIAXIAL
 TEMP. MAX. LIQUIDO: 25°
 MAX. ARENA: 40 gr/m³
 SENTIDO ROT.: ANTIHORARIO
 VALV. RET.: INCORPORADA

PUMP TYPE: MIXED FLOW
 MAXI. TEMP. LIQUID: 25°
 SAND MAX.: 40 gr/m³
 ROTATION: C.C.W.
 CHECK VAL.: BUILT IN

POMPE TYPE: SEMIAXIAL
 TEMP. MAX. LIQUIDE: 25°
 MAX. SABLE: 40 gr/m³
 SENS. ROT.: ANTIHORAIRE
 CLAPET RET.: INCORPORÉ

Tablas de selección / Selection charts / Tables de selection

Tipo Type	Motor - Moteur		l/min. m ³ /h	Caudal - Capacity - Debit					
	KW	HP		0	500	750	1000	1250	1500
SD 0,46-2F1	4	5,5	m.c.a.	27	22	20	17	13	7
SD 0,46-3F3	5,5	7,5		38	29	28	24	16	8
SD 0,46-3	7,5	10		43	36	33	29	22	13
SD 0,46-4	9,2	12,5		57	48	44	38	30	17
SD 0,46-5	11	15		71	60	55	48	37	21
SD 0,46-6F1	13	17,5		84	70	64	55	42	24
SD 0,46-7F2	15	20		96	80	74	63	48	26
SD 0,46-8	18,5	25		114	96	88	76	59	34
SD 0,46-10	22	30		142	120	110	95	74	42
SD 0,46-11	25	35		156	132	121	105	81	46
SD 0,46-13	30	40		185	156	143	124	96	55
SD 0,46-16	37	50		227	192	176	152	118	67
SD 0,46-20	45	60		284	240	220	190	148	84

Dimensiones / Dimensions / Dimensions

Materiales tipo A
 Impulsor: Hierro fundido
 Cuerpo: Hierro fundido
 Eje: Acero inox.

Material type A
 Impeller: Cast iron
 Bowl: Cast iron
 Shaft: St. steel

Materiaux type A
 Roue: Fonte
 Corps: Fonte
 Arbre: Acier inox.

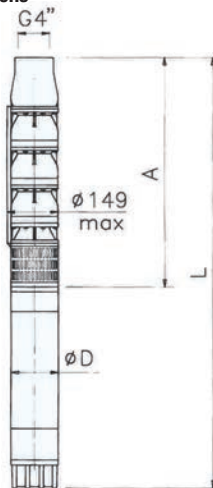

Tipo Type	Motor - Moteur		D mm	A mm	L mm	Peso Weight Poids (kg)
	KW	HP				
SD 0,46-2F1	4	5,5	90	566	1149	53
SD 0,46-3F3	5,5	7,5	90	683	1381	65
SD 0,46-3	7,5	10	140	713	1359	81
SD 0,46-4	9,2	12,5	140	830	1508	90
SD 0,46-5	11	15	140	947	1658	100
SD 0,46-6F1	13	17,5	140	1064	1784	117
SD 0,46-7F2	15	20	140	1181	1957	120
SD 0,46-8	18,5	25	140	1298	2139	133
SD 0,46-10	22	30	140	1532	2438	152
SD 0,46-11	25	35	140	1649	2726	189
SD 0,46-13	30	40	140	1883	2920	187
SD 0,46-16	37	50	140	2234	3639	259
SD 0,46-20	45	60	140	2702	3977	299

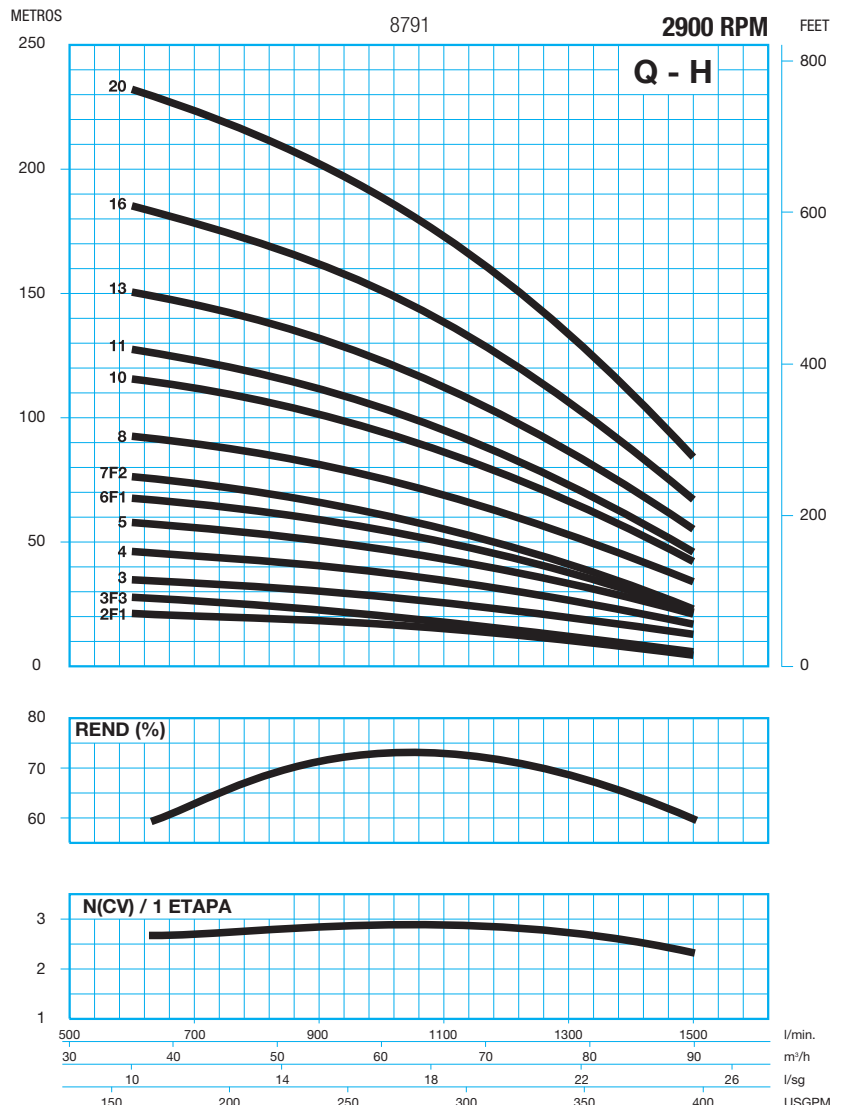

50HZ

BOMBA TIPO: SEMIAXIAL
 TEMP. MAX. LIQUIDO: 25°
 MAX. ARENA: 40 gr/m³
 SENTIDO ROT.: ANTIHORARIO
 VALV. RET.: INCORPORADA

PUMP TYPE: MIXED FLOW
 MAXI. TEMP. LIQUID: 25°
 SAND MAX.: 40 gr/m³
 ROTATION: C.C.W.
 CHECK VAL.: BUILT-IN

POMPE TYPE: SEMIAXIAL
 TEMP. MAX. LIQUIDE: 25°
 MAX. SABLE: 40 gr/m³
 SENS. ROT.: ANTIHORAIRE
 CLAPET RET.: INCORPORÉ

Tablas de selección / Selection charts / Tables de selection

Tipo Type	Motor - Moteur		l/min. m ³ /h	Caudal - Capacity - Debit					
	KW	HP		0	600	800	900	1000	1200
SD 0,62 - 2 F1	7,5	10	m.c.a.	50	41	36	33	29	22
SD 0,62 - 3 F3	9,2	12,5		68	55	49	44	37	27
SD 0,62 - 3 F1	11	15		77	59	55	50	43	32
SD 0,62 - 4 F4	13	17,5		92	76	67	61	52	38
SD 0,62 - 5 F5	15	20		108	90	79	71	58	42
SD 0,62 - 6 F6	18,5	25		133	111	98	88	74	54
SD 0,62 - 7 F7	22	30		159	130	116	103	88	64
SD 0,62 - 8 F8	26	35		184	153	134	122	104	77
SD 0,62 - 9 F9	30	40		207	172	151	137	117	87
SD 0,62 - 11 F10	37	50		258	214	188	171	146	109
SD 0,62 - 13 F11	45	60		309	258	225	204	175	131
SD 0,62 - 15 F12	52	70		360	297	262	237	204	153
SD 0,62 - 15 F6	55	75		390	319	273	250	219	162
SD 0,62 - 17 F13	59	80		410	339	299	270	233	175

Dimensiones / Dimensions / Dimensions

Materiales tipo A
 Impulsor: Hierro fundido
 Cuerpo: Hierro fundido
 Eje: Acero inox.

Material type A
 Impeller: Cast iron
 Bowl: Cast iron
 Shaft: St. steel

Materiaux type A
 Roue: Fonte
 Corps: Fonte
 Arbre: Acier inox.

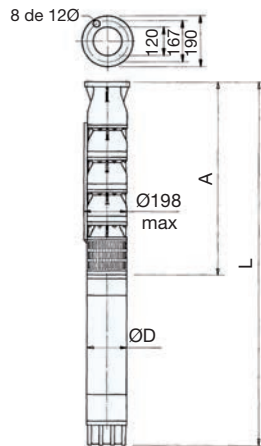

Tipo Type	Motor - Moteur		D mm	A mm	L mm	Peso Weight Poids (kg)
	KW	HP				
SD 0,62-2 F1	7,5	10	140	716	1426	99
SD 0,62-3 F3	9,2	12,5	140	852	1482	116
SD 0,62-3 F1	11	15	140	852	1627	118
SD 0,62-4 F4	13	17,5	140	988	1708	137
SD 0,62-5 F5	15	20	140	1124	1964	148
SD 0,62-6 F6	18,5	25	140	1260	2165	166
SD 0,62-7 F7	22	30	140	1396	2366	184
SD 0,62-8 F8	26	35	140	1532	2609	223
SD 0,62-9 F9	30	40	140	1668	2768	223
SD 0,62-11 F10	37	50	140	1940	3287	318
SD 0,62-13 F11	45	60	140	2212	3487	319
SD 0,62-15 F12	52	70	192	2484	3764	398
SD 0,62-15 F6	55	75	192	2484	3804	406
SD 0,62-17 F13	59	80	192	2620	3990	465

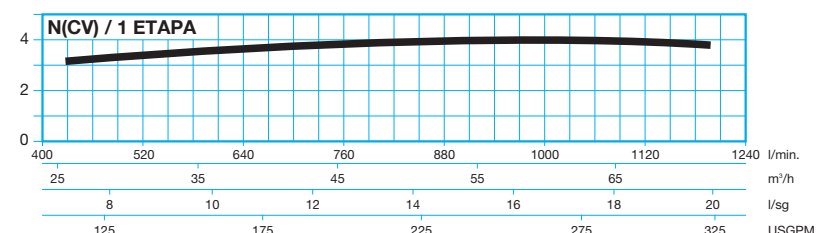
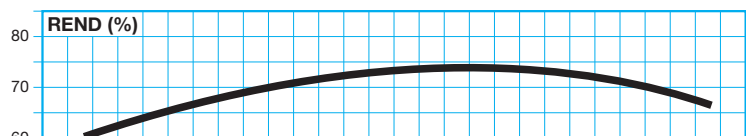
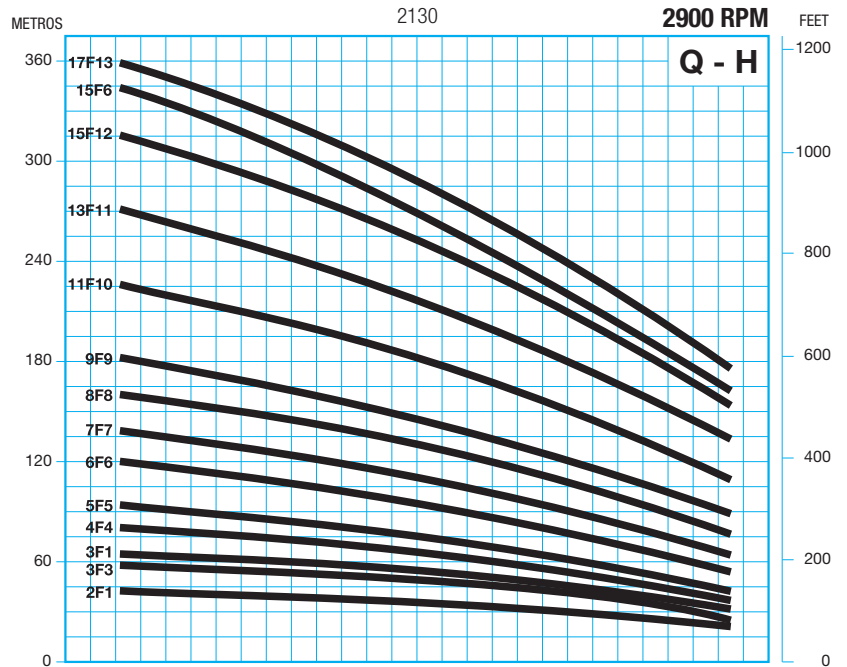

BOMBA TIPO: SEMIAXIAL
 TEMP. MAX. LIQUIDO: 25°
 MAX. ARENA: 40 gr/m³
 SENTIDO ROT.: ANTIHORARIO
 VALV. RET.: INCORPORADA

PUMP TYPE: MIXED FLOW
 MAXI. TEMP. LIQUID: 25°
 SAND MAX.: 40 gr/m³
 ROTATION: C.C.W.
 CHECK VAL.: BUILT-IN

POMPE TYPE: SEMIAXIAL
 TEMP. MAX. LIQUIDE: 25°
 MAX. SABLE: 40 gr/m³
 SENS. ROT.: ANTIHORAIRE
 CLAPET RET.: INCORPORÉ

Tablas de selección / Selection charts / Tables de selection

Tipo Type	Motor - Moteur		l/min. m ³ /h	Caudal - Capacity - Debit					
	KW	HP		0	800	1000	1200	1400	1600
SD 0,76 - 2 F1	9,2	12,5	m.c.a.	50	41	36	32	27	19
SD 0,76 - 2	11	15		57	46	41	36	31	23
SD 0,76 - 3 F2	13	17,5		71	59	53	46	38	26
SD 0,76 - 3	15	20		86	70	62	56	46	34
SD 0,76 - 4 F1	18,5	25		107	87	77	68	57	42
SD 0,76 - 5 F3	22	30		120	100	89	78	64	45
SD 0,76 - 5	26	35		143	115	102	90	76	57
SD 0,76 - 6 F1	30	40		164	134	119	104	88	64
SD 0,76 - 7	37	50		200	162	143	126	107	79
SD 0,76 - 9 F2	45	60		242	196	174	153	129	94
SD 0,76 - 10	52	70		285	230	206	179	152	113
SD 0,76 - 11 F3	55	75		290	235	210	182	152	120
SD 0,76 - 12 F2	59	80		327	266	236	206	175	128
SD 0,76 - 13	66	90		371	300	266	233	198	147
SD 0,76 - 15 F2	75	100		413	338	300	261	220	162

Dimensiones / Dimensions / Dimensions

Materiales tipo A
 Impulsor: Hierro fundido
 Cuerpo: Hierro fundido
 Eje: Acero inox.

Material type A
 Impeller: Cast iron
 Bowl: Cast iron
 Shaft: St. steel

Materiaux type A
 Roue: Fonte
 Corps: Fonte
 Arbre: Acier inox.

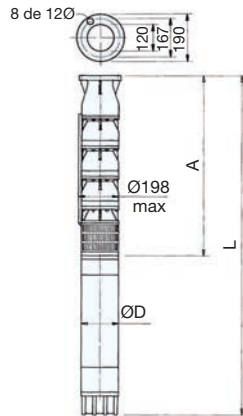

Tipo Type	Motor - Moteur		D mm	A mm	L mm	Peso Weight Poids (kg)
	KW	HP				
SD 0,76-2 F1	9,2	12,5	140	716	1346	105
SD 0,76-2	11	15	140	716	1491	106
SD 0,76-3 F2	13	17,5	140	852	1572	125
SD 0,76-3	15	20	140	852	1692	125
SD 0,76-4 F1	18,5	25	140	988	1893	142
SD 0,76-5 F3	22	30	140	1124	2094	160
SD 0,76-5	26	35	140	1124	2201	187
SD 0,76-6 F1	30	40	140	1260	2360	199
SD 0,76-7	37	50	140	1396	2743	270
SD 0,76-9 F2	45	60	140	1668	2943	271
SD 0,76-10	52	70	192	1804	3084	338
SD 0,76-11 F3	55	75	192	1940	3260	358
SD 0,76-12 F2	59	80	192	2076	3446	377
SD 0,76-13	66	90	192	2212	3672	404
SD 0,76-15 F2	75	100	192	2484	3977	473

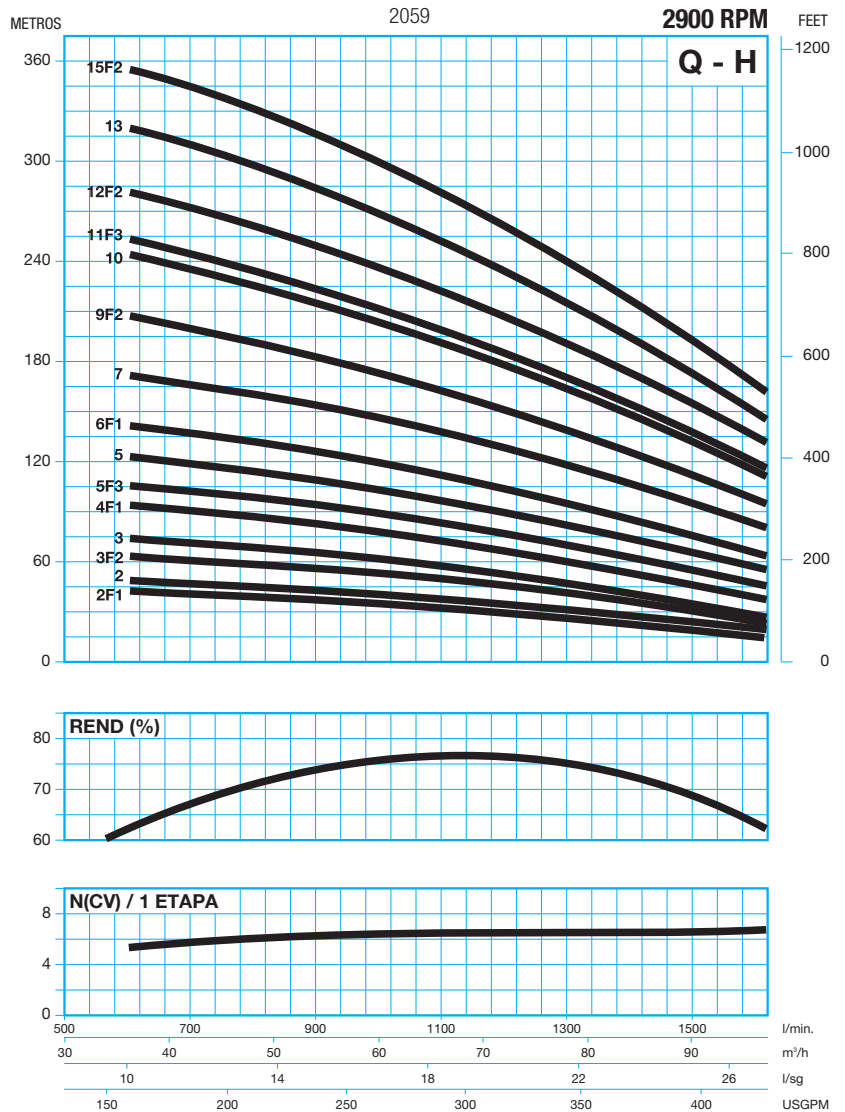

50HZ

BOMBA TIPO: SEMIAXIAL
 TEMP. MAX. LIQUIDO: 25°
 MAX. ARENA: 40 gr/m³
 SENTIDO ROT.: ANTIHORARIO
 VALV. RET.: INCORPORADA

PUMP TYPE: MIXED FLOW
 MAXI. TEMP. LIQUID: 25°
 SAND MAX.: 40 gr/m³
 ROTATION: C.C.W.
 CHECK VAL.: BUILT-IN

POMPE TYPE: SEMIAXIAL
 TEMP. MAX. LIQUIDE: 25°
 MAX. SABLE: 40 gr/m³
 SENS. ROT.: ANTIHORAIRE
 CLAPET RET.: INCORPORÉ

Tablas de selección / Selection charts / Tables de selection

Tipo Type	Motor - Moteur		l/min. m ³ /h	Caudal - Capacity - Debit					
	KW	HP		0	1000	1300	1500	1600	1900
				0	60	78	90	96	114
SD 0,82 - 1	7,5	10	m.c.a.	32	25	22	21	19	16
SD 0,82 - 2 F2	11	15		52	43	38	32	26	17
SD 0,82 - 2	15	20		64	49	48	41	38	31
SD 0,82 - 3 F2	18,5	25		84	68	61	53	45	33
SD 0,82 - 3	22	30		96	74	69	62	57	46
SD 0,82 - 4 F2	26	35		116	93	84	74	69	49
SD 0,82 - 4	30	40		128	98	92	82	76	62
SD 0,82 - 5	37	50		160	123	115	103	95	77
SD 0,82 - 6	45	60		192	147	138	123	114	92
SD 0,82 - 7	52	70		224	172	156	144	133	108
SD 0,82 - 8 F2	55	75	248	188	168	154	146	100	
SD 0,82 - 8	59	80	256	196	178	164	152	123	
SD 0,82 - 9	66	90	288	221	201	185	171	138	
SD 0,82 - 10	75	100	320	245	223	205	189	153	

Dimensiones / Dimensions / Dimensions

Materiales tipo A
 Impulsor: Hierro fundido
 Cuerpo: Hierro fundido
 Eje: Acero inox.

Material type A
 Impeller: Cast iron
 Bowl: Cast iron
 Shaft: St. steel

Materiaux type A
 Roue: Fonte
 Corps: Fonte
 Arbre: Acier inox.

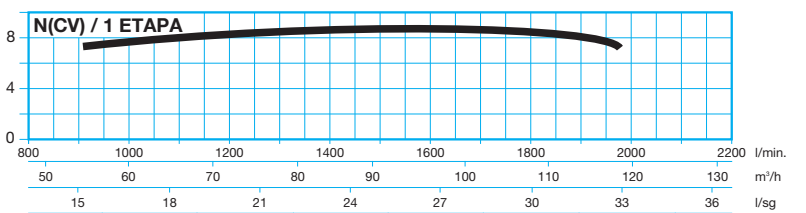
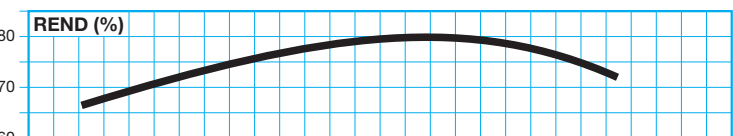
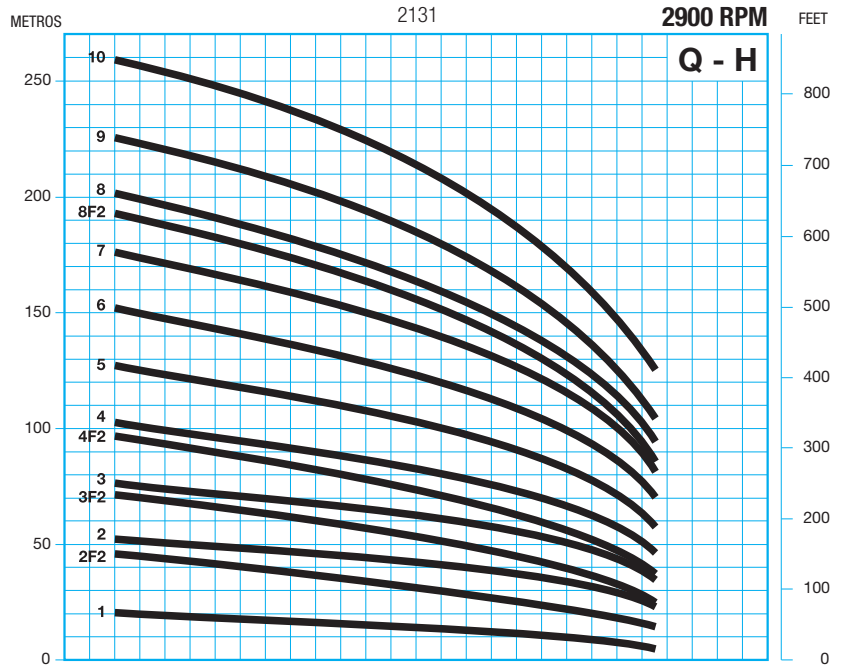
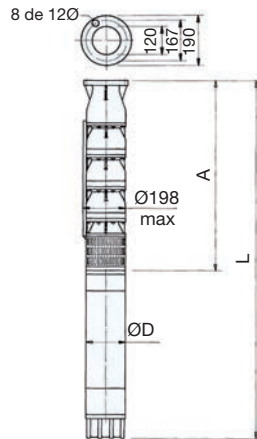

Tipo Type	Motor - Moteur		D mm	A mm	L mm	Peso Weight Poids (kg)
	KW	HP				
SD 0,82-1	7,5	10	140	580	1280	87
SD 0,82-2 F2	11	15	140	716	1491	106
SD 0,82-2	15	20	140	716	1556	112
SD 0,82-3 F2	18,5	25	140	852	1757	130
SD 0,82-3	22	30	140	852	1822	136
SD 0,82-4 F2	26	35	140	988	2065	162
SD 0,82-4	30	40	140	988	2088	162
SD 0,82-5	37	50	140	1124	2471	246
SD 0,82-6	45	60	140	1260	2537	235
SD 0,82-7	52	70	192	1396	2676	302
SD 0,82-8 F2	55	75	192	1532	2852	322
SD 0,82-8	59	80	192	1532	2902	329
SD 0,82-9	66	90	192	1668	3128	356
SD 0,82-10	75	100	192	1804	3297	413

BOMBA TIPO: SEMIAXIAL
 TEMP. MAX. LIQUIDO: 25°
 MAX. ARENA: 40 gr/m³
 SENTIDO ROT.: ANTIHORARIO
 VALV. RET.: INCORPORADA

PUMP TYPE: MIXED FLOW
 MAXI. TEMP. LIQUID: 25°
 SAND MAX.: 40 gr/m³
 ROTATION: C.C.W.
 CHECK VAL.: BUILT-IN

POMPE TYPE: SEMIAXIAL
 TEMP. MAX. LIQUIDE: 25°
 MAX. SABLE: 40 gr/m³
 SENS. ROT.: ANTIHORAIRE
 CLAPET RET.: INCORPORÉ

Tablas de selección / Selection charts / Tables de selection

Tipo Type	Motor - Moteur		l/min. m ³ /h	Caudal - Capacity - Debit					
	KW	HP		0	1750	2250	2500	2750	3100
				0	105	135	150	165	186
SD 0,88 - 1 F1	7,5	10	m.c.a.	23	17	14	12	10	6
SD 0,88 - 1	9,2	12,5		25	19	16	15	13	8
SD 0,88 - 2	18,5	25		51	39	33	29	26	17
SD 0,88 - 3 F3	22	30		69	50	42	36	29	18
SD 0,88 - 3	25	35		76	58	49	44	38	24
SD 0,88 - 4 F4	30	40		92	67	56	48	39	26
SD 0,88 - 5 F5	37	50		115	84	70	60	49	30
SD 0,88 - 6 F6	44	60		138	101	84	72	59	36
SD 0,88 - 6	52	70		152	116	98	87	77	49
SD 0,88 - 7 F2	59	80		173	130	109	97	83	54
SD 0,88 - 9 F9	66	90		207	151	126	102	88	56
SD 0,88 - 9 F2	75	100		223	168	142	126	109	70

Dimensiones / Dimensions / Dimensions

Materiales tipo A
 Impulsor: Hierro fundido
 Cuerpo: Hierro fundido
 Eje: Acero inox.

Material type A
 Impeller: Cast iron
 Bowl: Cast iron
 Shaft: St. steel

Materiaux type A
 Roue: Fonte
 Corps: Fonte
 Arbre: Acier inox.

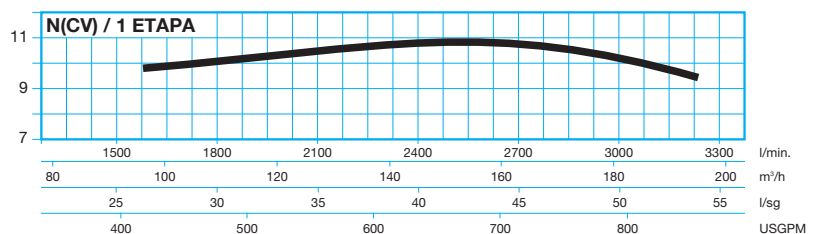
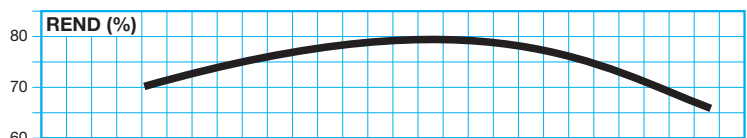
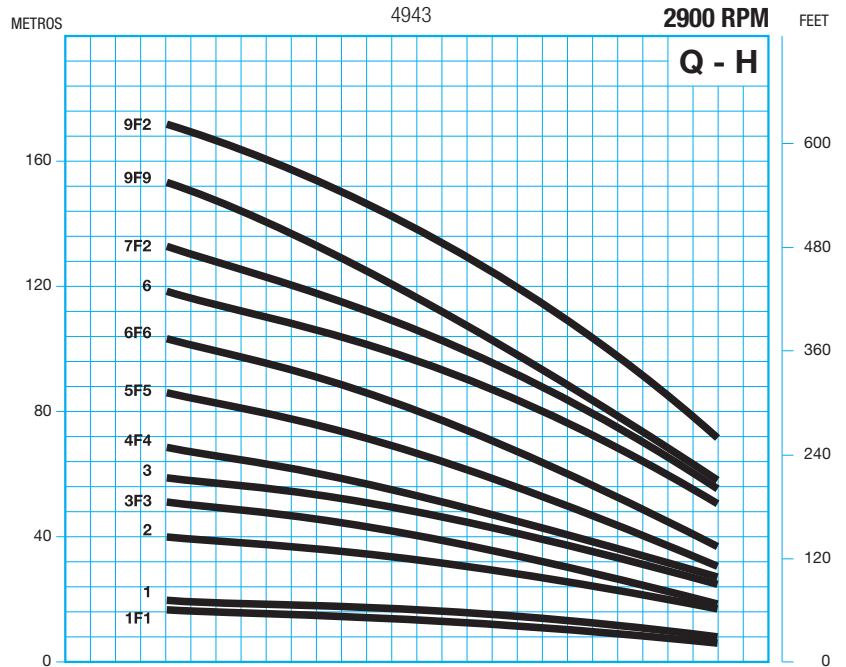
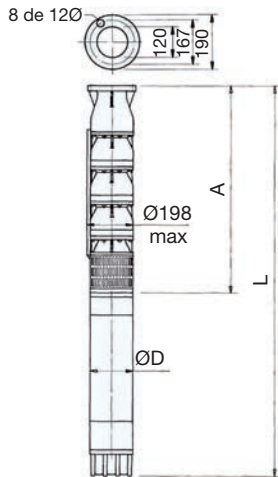

Tipo Type	Motor - Moteur		D mm	A mm	L mm	Peso Weight Poids (kg)
	KW	HP				
SD 0,88-1 F1	7,5	10	140	580	1216	86
SD 0,88-1	9,2	12,5	140	580	1248	91
SD 0,88-2	18,5	25	140	716	1547	116
SD 0,88-3 F3	22	30	140	852	1478	134
SD 0,88-3	25	35	140	852	1659	166
SD 0,88-4 F4	30	40	140	988	2014	157
SD 0,88-5 F5	37	50	140	1124	2471	250
SD 0,88-6 F6	44	60	140	1260	2535	274
SD 0,88-6	52	70	192	1260	2540	288
SD 0,88-7 F2	59	80	192	1396	2766	314
SD 0,88-9 F9	66	90	192	1668	3128	350
SD 0,88-9 F2	75	100	192	1668	3218	366

BOMBA TIPO: SEMIAXIAL
 TEMP. MAX. LIQUIDO: 25°
 MAX. ARENA: 40 gr/m³
 SENTIDO ROT.: ANTIHORARIO
 VALV. RET.: BAJO PEDIDO

PUMP TYPE: MIXED FLOW
 MAXI. TEMP. LIQUID: 25°
 SAND MAX.: 40 gr/m³
 ROTATION: C.C.W.
 CHECK VAL.: ON REQUEST

POMPE TYPE: SEMIAXIAL
 TEMP. MAX. LIQUIDE: 25°
 MAX. SABLE: 40 gr/m³
 SENS. ROT.: ANTIHORAIRE
 CLAPET RET.: SUR DEMENDE

Tablas de selección / Selection charts / Tables de selection

Tipo Type	Motor - Moteur		l/min. m ³ /h	Caudal - Capacity - Debit					
	KW	HP		0	1500	1750	2000	2250	2500
SD 1 - 1	11	15	m.c.a.	29	24	23	22	20	17
SD 1 - 2	22	30		58	49	47	44	40	34
SD 1 - 3 F1	30	40		80	67	63	59	53	44
SD 1 - 3	37	50		87	74	70	66	60	51
SD 1 - 4	45	60		116	98	93	88	80	68
SD 1 - 5	55	75		145	123	116	110	100	85
SD 1 - 6	66	90		174	148	140	132	120	102
SD 1 - 7	75	100		203	172	163	154	140	119
SD 1 - 8	92	125		232	197	186	176	160	136
SD 1 - 10	110	150		290	246	233	220	200	170
SD 1 - 12	130	175		348	295	280	264	240	204

Dimensiones / Dimensions / Dimensions

Materiales tipo B
 Impulsor: Bronce
 Cuerpo: Hierro fundido
 Eje: Acero inox.

Material type B
 Impeller: Bronze
 Bowl: Cast iron
 Shaft: St. steel

Materiaux type B
 Roue: Bronze
 Corps: Fonte
 Arbre: Acier inox.

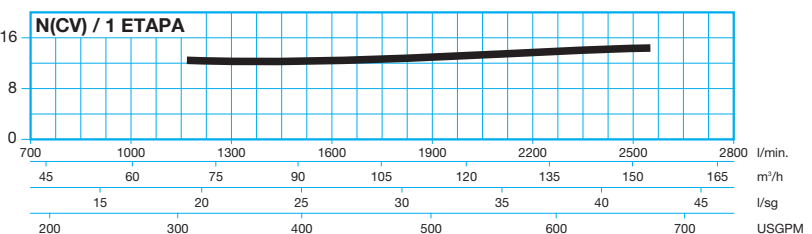
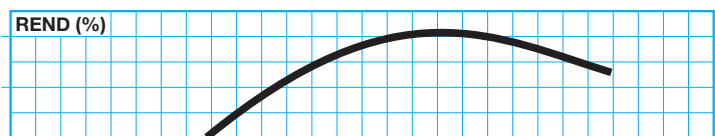
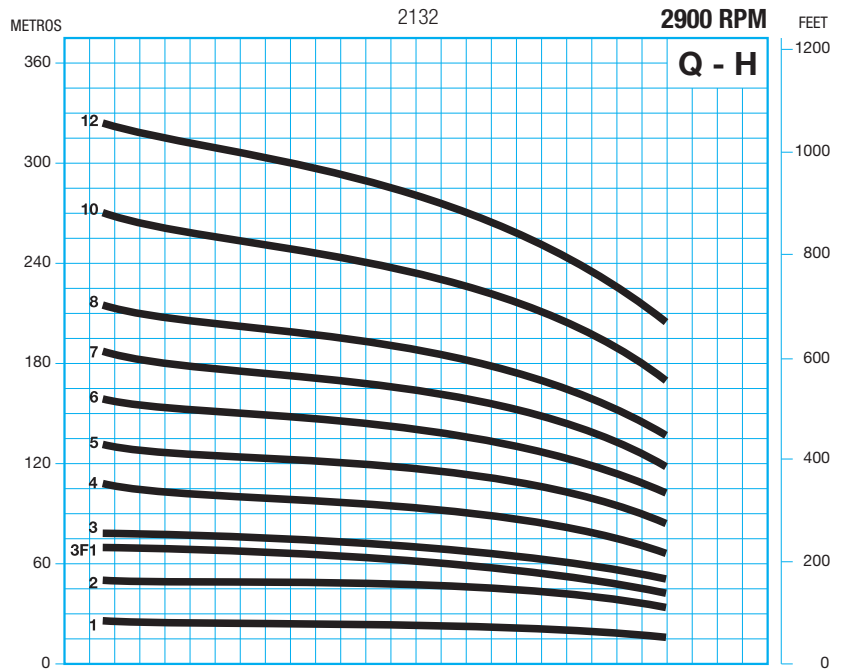
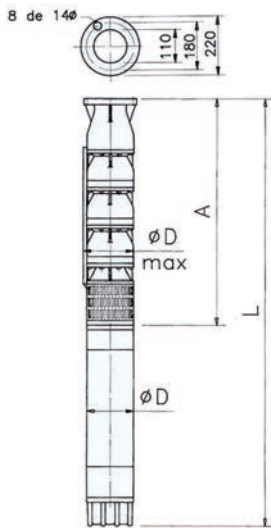

Tipo Type	Motor - Moteur		D máx.	D Motor-M	A mm	L mm	Peso Weight Poids (kg)
	KW	HP					
SD 1-1	11	15	240	140	745	1520	154
SD 1-2	22	30	240	140	883	1853	194
SD 1-3 F1	30	40	240	140	1043	2144	230
SD 1-3	37	50	240	140	1043	2390	302
SD 1-4	45	60	260	140	1203	2480	342
SD 1-5	55	75	260	192	1363	2683	386
SD 1-6	66	90	260	192	2973	2920	430
SD 1-7	75	100	260	192	1620	3170	468
SD 1-8	92	125	260	192	1780	3280	604
SD 1-10	110	150	260	192	2152	3996	683
SD 1-12	130	175	260	236	2472	4312	777

BOMBA TIPO: SEMIAXIAL
 TEMP. MAX. LIQUIDO: 25°
 MAX. ARENA: 40 gr/m³
 SENTIDO ROT.: ANTIHORARIO
 VALV. RET.: BAJO PEDIDO

PUMP TYPE: MIXED FLOW
 MAXI. TEMP. LIQUID: 25°
 SAND MAX.: 40 gr/m³
 ROTATION: C.C.W.
 CHECK VAL.: ON REQUEST

POMPE TYPE: SEMIAXIAL
 TEMP. MAX. LIQUIDE: 25°
 MAX. SABLE: 40 gr/m³
 SENS. ROT.: ANTIHORAIRE
 CLAPET RET.: SUR DEMENDE

Tablas de selección / Selection charts / Tables de selection

Tipo Type	Motor - Moteur		l/min. m ³ /h	Caudal - Capacity - Debit					
	KW	HP		0	1750	2250	2750	3250	3750
				0	105	135	165	195	225
SD 1,8-1F1	18	25	m.c.a.	40	35	33	30	23	10
SD 1,8-1	22	30		46	40	38	35	32	23
SD 1,8-2F2	37	50		80	70	65	60	46	20
SD 1,8-2	44	60		92	80	76	70	64	46
SD 1,8-3F3	55	75		120	105	98	90	69	30
SD 1,8-3F2	59	80		126	110	103	95	78	43
SD 1,8-3	66	90		138	120	114	105	96	69
SD 1,8-4F4	74	100		160	140	130	120	92	40
SD 1,8-4	92	125		184	160	152	140	128	92
SD 1,8-5	110	150		230	200	190	175	160	115
SD 1,8-6F2	129	175		264	230	217	200	174	112
SD 1,8-7F2	147	200		310	270	255	235	206	135
SD 1,8-7	166	225		322	280	266	245	224	161
SD 1,8-8	184	250		368	320	304	280	256	184
SD 1,8-9	221	300		414	360	342	315	288	207

Dimensiones / Dimensions / Dimensions

Materiales tipo A
 Impulsor: Hierro fundido
 Cuerpo: Hierro fundido
 Eje: Acero inox.

Material type A
 Impeller: Cast iron
 Bowl: Cast iron
 Shaft: St. steel

Materiaux type A
 Roue: Fonte
 Corps: Fonte
 Arbre: Acier inox.

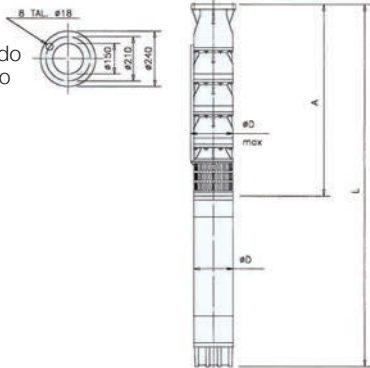

Tipo Type	Motor - Moteur		D máx.	D Motor-M	A mm	L mm	Peso Weight Poids (kg)
	KW	HP					
SD 1,8-1F1	18	25	250	140	710	1572	127
SD 1,8-1	22	30	250	140	710	1766	134
SD 1,8-2F2	37	50	254	140	895	2242	252
SD 1,8-2	44	60	254	140	895	2170	266
SD 1,8-3F3	55	75	254	192	1080	2400	313
SD 1,8-3F2	59	80	254	192	1080	2450	320
SD 1,8-3	66	90	254	192	1080	2540	335
SD 1,8-4F4	74	100	254	192	1265	2815	376
SD 1,8-4	92	125	260	192	1265	2801	490
SD 1,8-5	110	150	260	192	1450	3294	550
SD 1,8-6F2	129	175	260	236	1635	3475	625
SD 1,8-7F2	147	200	260	236	1820	3650	690
SD 1,8-7	166	225	276	236	1820	3742	771
SD 1,8-8	184	250	276	236	2005	3927	796
SD 1,8-9	221	300	276	236	2190	4950	881

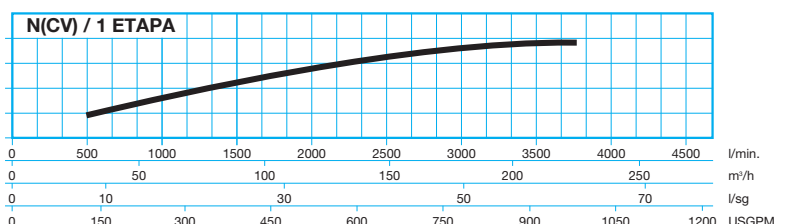
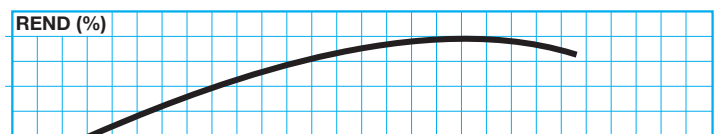
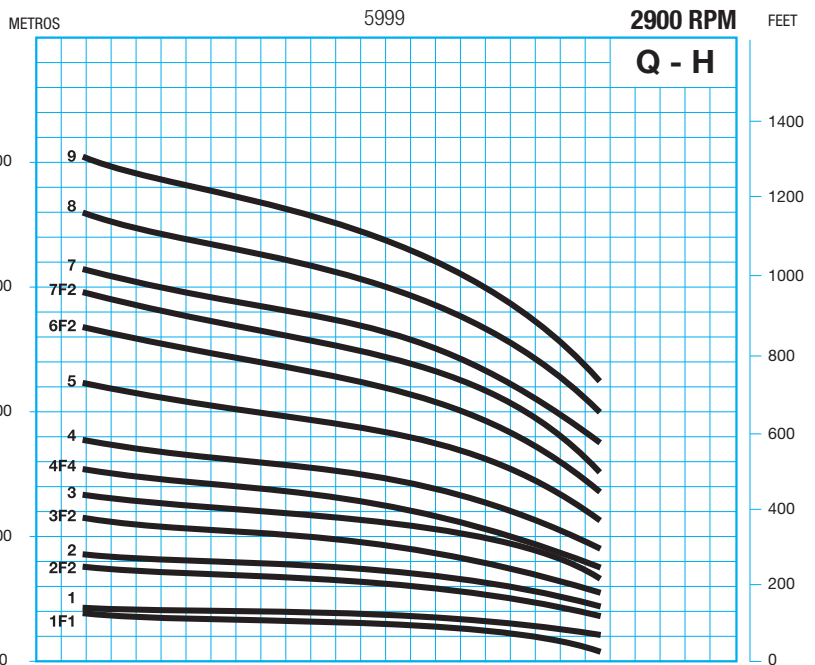

BOMBA TIPO: SEMIAXIAL
 TEMP. MAX. LIQUIDO: 25°
 MAX. ARENA: 160 gr/m³
 SENTIDO ROT.: ANTIHORARIO
 VALV. RET.: BAJO PEDIDO

PUMP TYPE: MIXED FLOW
 MAXI. TEMP. LIQUID: 25°
 SAND MAX.: 160 gr/m³
 ROTATION: C.C.W.
 CHECK VAL.: ON REQUEST

POMPE TYPE: SEMIAXIAL
 TEMP. MAX. LIQUIDE: 25°
 MAX. SABLE: 160 gr/m³
 SENS. ROT.: ANTIHORAIRE
 CLAPET RET.: SUR DEMENDE

Tablas de selección / Selection charts / Tables de selection

Tipo Type	Motor - Moteur		l/min. m ³ /h	Caudal - Capacity - Debit					
	KW	HP		0	1750	2250	2750	3250	3750
				0	105	135	165	195	225
SDX 1,8-1F1	18	25	m.c.a.	40	35	33	30	23	10
SDX 1,8-1	22	30		46	40	38	35	32	23
SDX 1,8-2F2	37	50		80	70	65	60	46	20
SDX 1,8-2	44	60		92	80	76	70	64	46
SDX 1,8-3F3	55	75		120	105	98	90	69	30
SDX 1,8-3F2	59	80		126	110	103	95	78	43
SDX 1,8-3	66	90		138	120	114	105	96	69
SDX 1,8-4F4	74	100		160	140	130	120	92	40
SDX 1,8-4	92	125		184	160	152	140	128	92
SDX 1,8-5	110	150		230	200	190	175	160	115
SDX 1,8-6F2	129	175		264	230	217	200	174	112
SDX 1,8-7F2	147	200		310	270	255	235	206	135
SDX 1,8-7	166	225		322	280	266	245	224	161
SDX 1,8-8	184	250		368	320	304	280	256	184
SDX 1,8-9	221	300		414	360	342	315	288	207

Dimensiones / Dimensions / Dimensions

Materiales tipo E
 Impulsor: AISI 316
 Cuerpo: AISI 316
 Eje: Acero inox.

Material type E
 Impeller: AISI 316
 Bowl: AISI 316
 Shaft: St. steel

Materiaux type E
 Roue: AISI 316
 Corps: AISI 316
 Arbre: Acier inox.

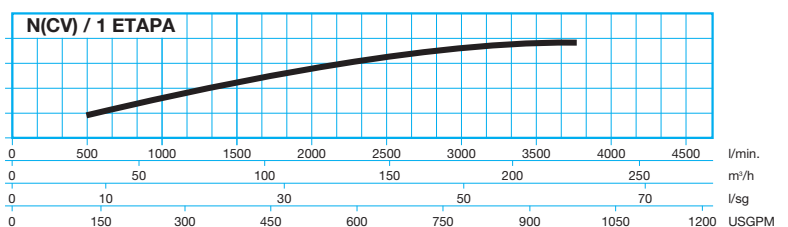
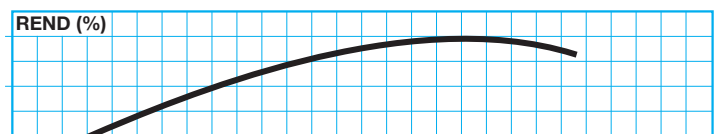
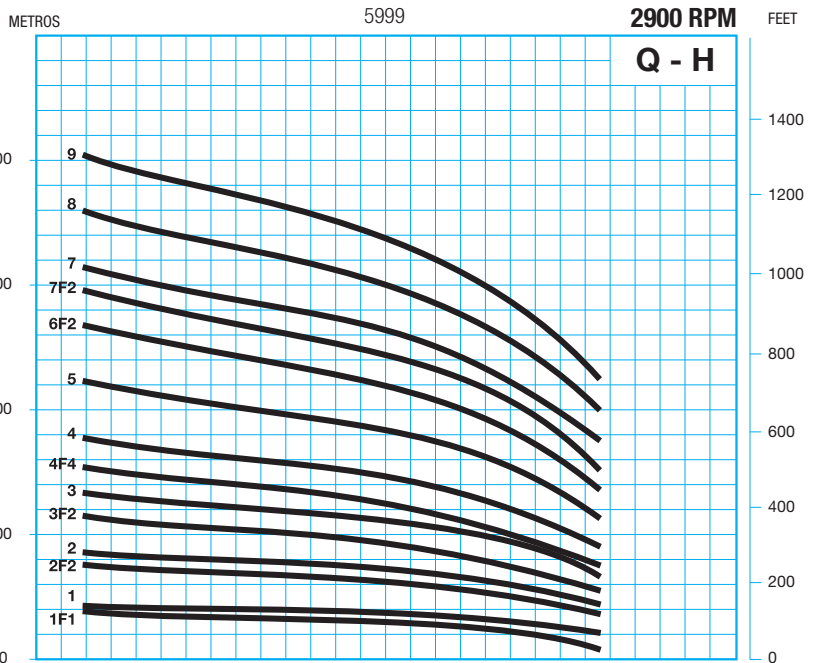
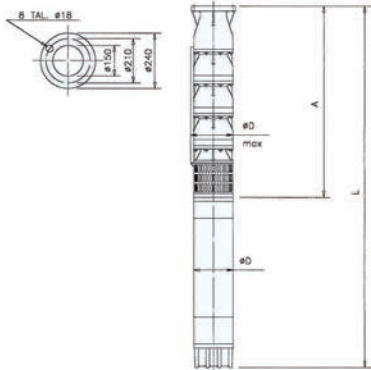

Tipo Type	Motor - Moteur		D máx.	D Motor-M	A mm	L mm	Peso Weight Poids (kg)
	KW	HP					
SDX 1,8-1F1	18	25	250	140	710	1572	127
SDX 1,8-1	22	30	250	140	710	1766	134
SDX 1,8-2F2	37	50	254	140	895	2242	252
SDX 1,8-2	44	60	254	140	895	2170	266
SDX 1,8-3F3	55	75	254	192	1080	2400	313
SDX 1,8-3F2	59	80	254	192	1080	2450	320
SDX 1,8-3	66	90	254	192	1080	2540	335
SDX 1,8-4F4	74	100	254	192	1265	2815	376
SDX 1,8-4	92	125	260	192	1265	2801	490
SDX 1,8-5	110	150	260	192	1450	3294	550
SDX 1,8-6F2	129	175	260	236	1635	3245	625
SDX 1,8-7F2	147	200	260	236	1820	3560	690
SDX 1,8-7	166	225	276	236	1820	3742	771
SDX 1,8-8	184	250	276	236	2005	3927	796
SDX 1,8-9	221	300	276	236	2190	4230	881

BOMBA TIPO: SEMIAXIAL
 TEMP. MAX. LIQUIDO: 25°
 MAX. ARENA: 40 gr/m³
 SENTIDO ROT.: ANTIHORARIO
 VALV. RET.: BAJO PEDIDO

PUMP TYPE: MIXED FLOW
 MAXI. TEMP. LIQUID: 25°
 SAND MAX.: 40 gr/m³
 ROTATION: C.C.W.
 CHECK VALV.: ON REQUEST

POMPE TYPE: SEMIAXIAL
 TEMP. MAX. LIQUIDE: 25°
 MAX. SABLE: 40 gr/m³
 SENS. ROT.: ANTIHORAIRE
 CLAPET RET.: SUR DEMENDE

Tablas de selección / Selection charts / Tables de selection

Tipo Type	Motor - Moteur		l/min. m ³ /h	Caudal - Capacity - Debit					
	KW	HP		0	2400	3000	3600	4200	4800
SD 2,5-1FE	18	25	m.c.a.	37	30	27	24	19	14
SD 2,5-1F1	22	30		41	34	32	29	25	21
SD 2,5-2FE	37	50		73	60	54	48	39	28
SD 2,5-2F2	44	60		82	69	64	58	51	42
SD 2,5-2F1	55	75		89	76	72	68	60	52
SD 2,5-3F3	66	90		122	103	96	87	76	63
SD 2,5-3F2	74	100		130	111	104	97	85	73
SD 2,5-3	92	125		144	125	119	116	103	92
SD 2,5-4F2	110	150		178	152	144	136	120	104
SD 2,5-5F3	129	175		218	187	176	165	145	125
SD 2,5-5F1	147	200		233	202	192	180	163	144
SD 2,5-7F4	184	250		307	263	248	233	205	176
SD 2,5-7	221	300		336	293	279	266	241	216

Dimensiones / Dimensions / Dimensions

Materiales tipo A
 Impulsor: Hierro fundido
 Cuerpo: Hierro fundido
 Eje: Acero inox.

Material type A
 Impeller: Cast iron
 Bowl: Cast iron
 Shaft: St. steel

Matériaux type A
 Roue: Fonte
 Corps: Fonte
 Arbre: Acier inox.

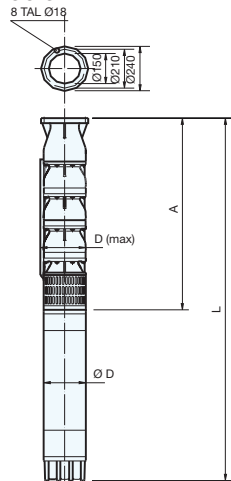

Tipo Type	Motor - Moteur		D máx.	D Motor-M	A mm	L mm	Peso Weight Poids (kg)
	KW	HP					
SD 2,5-1FE	18	25	250	140	710	1551	127
SD 2,5-1F1	22	30	250	140	710	1616	134
SD 2,5-2FE	37	50	254	140	895	2242	252
SD 2,5-2F2	44	60	254	140	895	2170	266
SD 2,5-2F1	55	75	254	192	895	2220	313
SD 2,5-3F3	66	90	254	192	1080	2545	335
SD 2,5-3F2	74	100	254	192	1080	2635	376
SD 2,5-3	92	125	254	192	1080	2801	490
SD 2,5-4F2	110	150	260	192	1265	2775	550
SD 2,5-5F3	129	175	260	236	1450	3060	625
SD 2,5-5F1	147	200	260	236	1450	3372	690
SD 2,5-7F4	184	250	276	236	1820	3742	821
SD 2,5-7	221	300	276	236	1820	3860	906

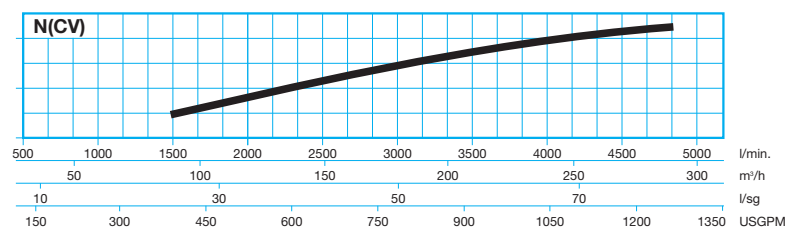
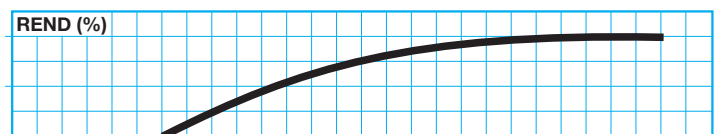
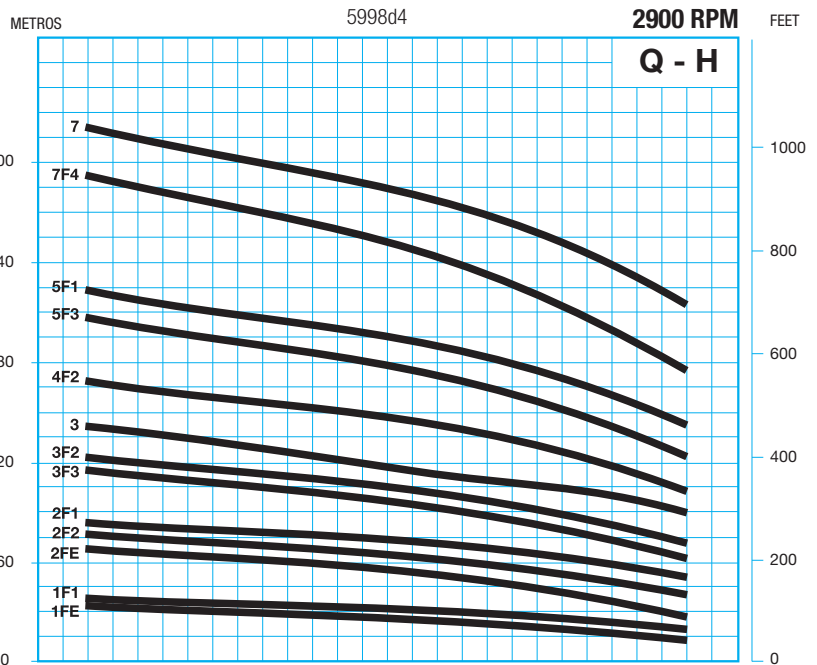

50HZ

BOMBA TIPO: SEMIAXIAL
 TEMP. MAX. LIQUIDO: 25°
 MAX. ARENA: 160 gr/m³
 SENTIDO ROT.: ANTIHORARIO
 VALV. RET.: BAJO PEDIDO

PUMP TYPE: MIXED FLOW
 MAXI. TEMP. LIQUID: 25°
 SAND MAX.: 160 gr/m³
 ROTATION: C.C.W.
 CHECK VAL.: ON REQUEST

POMPE TYPE: SEMIAXIAL
 TEMP. MAX. LIQUIDE: 25°
 MAX. SABLE: 160 gr/m³
 SENS. ROT.: ANTIHORAIRE
 CLAPET RET.: SUR DEMENDE

Tablas de selección / Selection charts / Tables de selection

Tipo Type	Motor - Moteur		l/min. m ³ /h	Caudal - Capacity - Debit					
	KW	HP		0	2400	3000	3600	4200	4800
SDX 2,5-1FE	18	25	m.c.a.	37	30	27	24	19	14
SDX 2,5-1F1	22	30		41	34	32	29	25	21
SDX 2,5-2FE	37	50		73	60	54	48	39	28
SDX 2,5-2F2	44	60		82	69	64	58	51	42
SDX 2,5-2F1	55	75		89	76	72	68	60	52
SDX 2,5-3F3	66	90		122	103	96	87	76	63
SDX 2,5-3F2	74	100		130	111	104	97	85	73
SDX 2,5-3	92	125		144	125	119	116	103	92
SDX 2,5-4F2	110	150		178	152	144	136	120	104
SDX 2,5-5F3	129	175		218	187	176	165	145	125
SDX 2,5-5F1	147	200		233	202	192	180	163	144
SDX 2,5-7F4	184	250		307	263	248	233	205	176
SDX 2,5-7	221	300		336	293	279	266	241	216

Dimensiones / Dimensions / Dimensions

Materiales tipo E
 Impulsor: AISI 316
 Cuerpo: AISI 316
 Eje: Acero inox.

Material type E
 Impeller: AISI 316
 Bowl: AISI 316
 Shaft: St. steel

Materiaux type E
 Roue: AISI 316
 Corps: AISI 316
 Arbre: Acier inox.

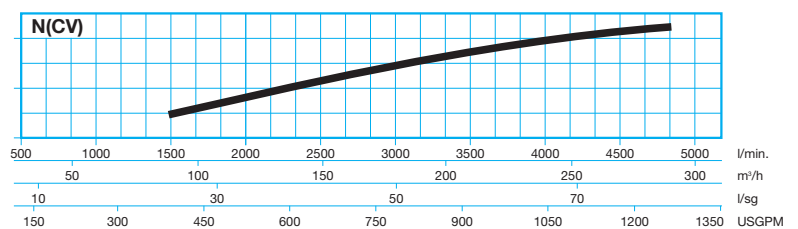
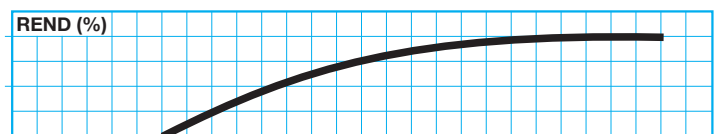
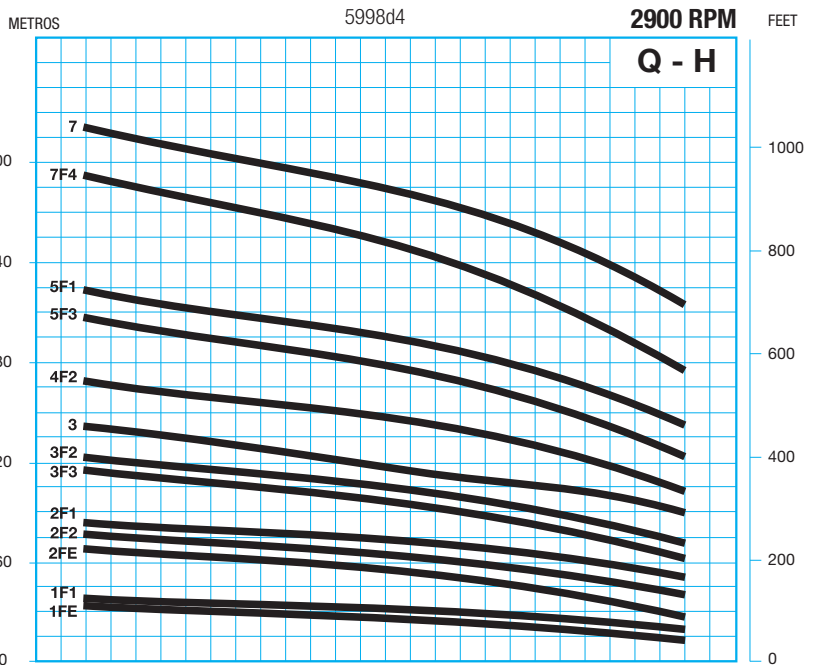
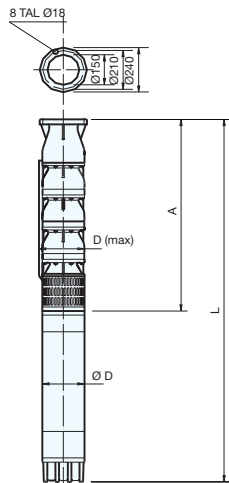

Tipo Type	Motor - Moteur		D máx.	D Motor-M	A mm	L mm	Peso Weight Poids (kg)
	KW	HP					
SDX 2,5-1FE	18	25	250	140	710	1551	127
SDX 2,5-1F1	22	30	250	140	710	1616	134
SDX 2,5-2FE	37	50	254	140	895	2242	252
SDX 2,5-2F2	44	60	254	140	895	2170	266
SDX 2,5-2F1	55	75	254	192	895	2220	313
SDX 2,5-3F3	66	90	254	192	1080	2545	335
SDX 2,5-3F2	74	100	254	192	1080	2635	376
SDX 2,5-3	92	125	254	192	1080	2801	490
SDX 2,5-4F2	110	150	260	192	1265	3109	550
SDX 2,5-5F3	129	175	260	236	1450	3060	625
SDX 2,5-5F1	147	200	260	236	1450	3370	690
SDX 2,5-7F4	184	250	276	236	1820	3742	821
SDX 2,5-7	221	300	276	236	1820	3860	906

BOMBA TIPO: SEMIAXIAL
 TEMP. MAX. LIQUIDO: 25°
 MAX. ARENA: 40 gr/m³
 SENTIDO ROT.: ANTIHORARIO
 VALV. RET.: BAJO PEDIDO

PUMP TYPE: MIXED FLOW
 MAXI. TEMP. LIQUID: 25°
 SAND MAX.: 40 gr/m³
 ROTATION: C.C.W.
 CHECK VAL.: ON REQUEST

POMPE TYPE: SEMIAXIAL
 TEMP. MAX. LIQUIDE: 25°
 MAX. SABLE: 40 gr/m³
 SENS. ROT.: ANTIHORAIRE
 CLAPET RET.: SUR DEMENDE

Tablas de selección / Selection charts / Tables de selection

Tipo Type	Motor - Moteur		l/min. m ³ /h	Caudal - Capacity - Debit						
	KW	HP		0	2500	3000	3500	4000	4500	5000
SD 2,6-1F1E	22	30	m.c.a.	37	31	30	28	26	22	17
SD 2,6-1F1	30	40		42	37	35	33	30	27	22
SD 2,6-1	37	50		49	41	39	37	35	32	27
SD 2,6 2F2E	45	60		74	62	60	56	52	44	34
SD 2,6-2F2	55	75		84	74	71	67	61	55	45
SD 2,6-2F1	59	80		91	78	75	71	66	60	50
SD 2,6-2	66	90		98	82	79	76	71	64	55
SD 2,6-3F3E	74	100		111	99	95	89	82	71	56
SD 2,6-3F2	92	125		133	117	112	106	96	89	74
SD 2,6-3	92	125		147	125	120	115	108	98	84
SD 2,6-4F4	110	150		168	147	140	132	122	110	90
SD 2,6-4	129	175		176	166	160	154	144	130	112
SD 2,6-5F5	147	200		210	184	175	165	152	137	112
SD 2,6-5F2	147	200		231	206	201	192	180	163	140
SD 2,6-6	184	250		294	249	240	231	216	195	168
SD 2,6-7	221	300	343	291	280	270	252	225	196	

Dimensiones / Dimensions / Dimensions

Materiales tipo A
 Impulsor: Hierro fundido
 Cuerpo: Hierro fundido
 Eje: Acero inox.

Material type A
 Impeller: Cast iron
 Bowl: Cast iron
 Shaft: St. steel

Materiaux type A
 Roue: Fonte
 Corps: Fonte
 Arbre: Acier inox.

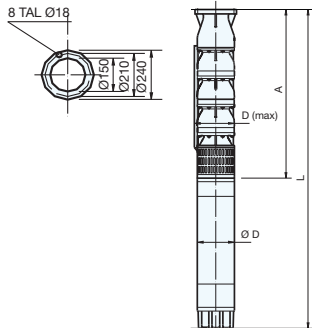

Tipo Type	Motor - Moteur		D máx.	D Motor-M	A mm	L mm	Peso Weight Poids (kg)
	KW	HP					
SD 2,6-1F1E	22	30	250	142	710	1889	134
SD 2,6-1F1	30	40	250	142	710	2030	152
SD 2,6-1	37	50	250	142	710	2130	159
SD 2,6 2F2E	45	60	250	142	895	2375	258
SD 2,6-2F2	55	75	250	192	895	2283	291
SD 2,6-2F1	59	80	250	192	895	2338	299
SD 2,6-2	66	90	250	192	895	2363	308
SD 2,6-3F3E	74	100	250	192	1080	2573	481
SD 2,6-3F2	92	125	250	192	1080	2718	500
SD 2,6-3	92	125	250	192	1080	2718	500
SD 2,6-4F4	110	150	250	192	1265	3109	636
SD 2,6-4	129	175	250	236	1265	2875	705
SD 2,6-5F5	147	200	250	236	1450	3190	751
SD 2,6-5F2	147	200	250	236	1450	3190	751
SD 2,6-6	184	250	250	236	1635	3585	976
SD 2,6-7	221	300	250	236	1820	3860	1091

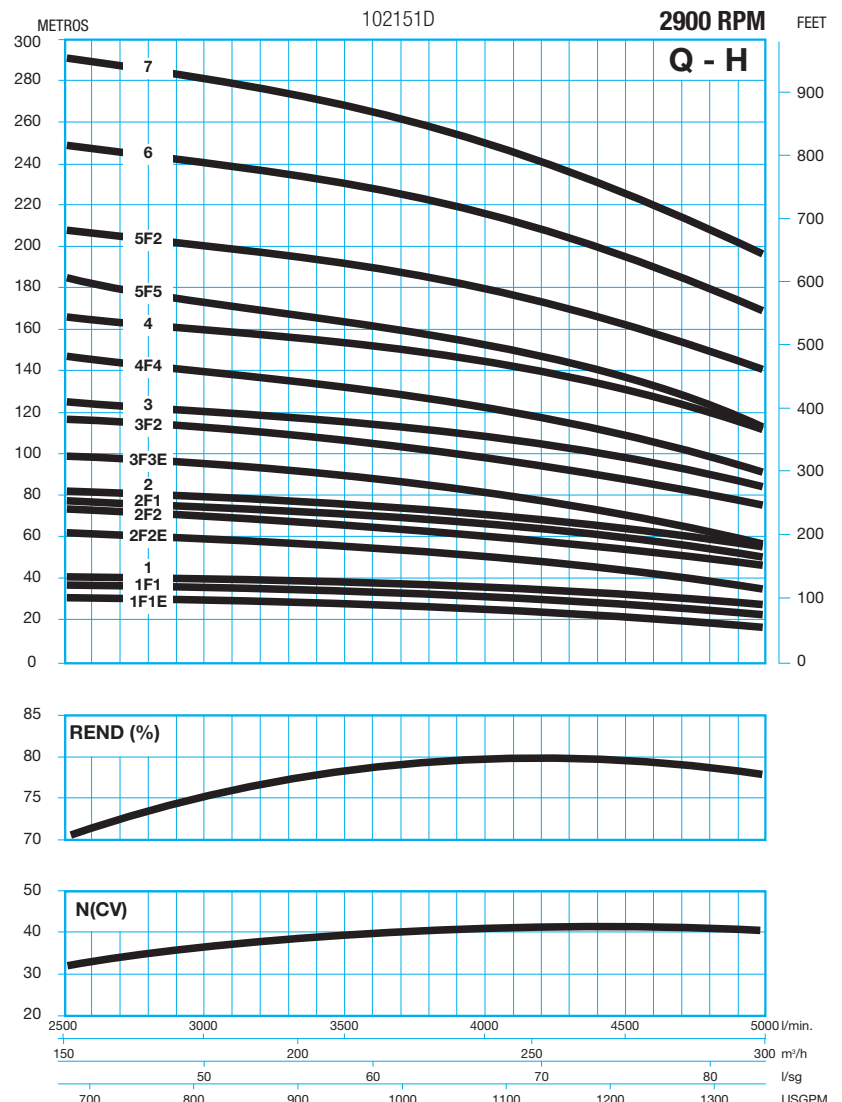

BOMBA TIPO: SEMIAXIAL
 TEMP. MAX. LIQUIDO: 25°
 MAX. ARENA: 160 gr/m³
 SENTIDO ROT.: ANTIHORARIO
 VALV. RET.: BAJO PEDIDO

PUMP TYPE: MIXED FLOW
 MAXI. TEMP. LIQUID: 25°
 SAND MAX.: 160 gr/m³
 ROTATION: C.C.W.
 CHECK VAL.: ON REQUEST

POMPE TYPE: SEMIAXIAL
 TEMP. MAX. LIQUIDE: 25°
 MAX. SABLE: 160 gr/m³
 SENS. ROT.: ANTIHORAIRE
 CLAPET RET.: SUR DEMENDE

Tablas de selección / Selection charts / Tables de selection

Tipo Type	Motor - Moteur		l/min. m ³ /h	Caudal - Capacity - Debit						
	KW	HP		0	2500	3000	3500	4000	4500	5000
SDX 2,6-1F1E	22	30	m.c.a.	37	31	30	28	26	22	17
SDX 2,6-1F1	30	40		42	37	35	33	30	27	22
SDX 2,6-1	37	50		49	41	39	37	35	32	27
SDX 2,6 2F2E	45	60		74	62	60	56	52	44	34
SDX 2,6-2F2	55	75		84	74	71	67	61	55	45
SDX 2,6-2F1	59	80		91	78	75	71	66	60	50
SDX 2,6-2	66	90		98	82	79	76	71	64	55
SDX 2,6-3F3E	74	100		111	99	95	89	82	71	56
SDX 2,6-3F2	92	125		133	117	112	106	96	89	74
SDX 2,6-3	92	125		147	125	120	115	108	98	84
SDX 2,6-4F4	110	150		168	147	140	132	122	110	90
SDX 2,6-4	129	175		176	166	160	154	144	130	112
SDX 2,6-5F5	147	200		210	184	175	165	152	137	112
SDX 2,6-5F2	147	200		231	206	201	192	180	163	140
SDX 2,6-6	184	250		294	249	240	231	216	195	168
SDX 2,6-7	221	300	343	291	280	270	252	225	196	

Dimensiones / Dimensions / Dimensions

Materiales tipo E
 Impulsor: AISI 316
 Cuerpo: AISI 316
 Eje: Acero inox.

Material type E
 Impeller: AISI 316
 Bowl: AISI 316
 Shaft: St. steel

Materiaux type E
 Roue: AISI 316
 Corps: AISI 316
 Arbre: Acier inox.

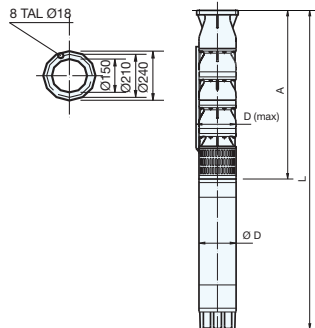

Tipo Type	Motor - Moteur		D máx.	D Motor-M	A mm	L mm	Peso Weight Poids (kg)
	KW	HP					
SDX 2,6-1F1E	22	30	250	142	710	1889	134
SDX 2,6-1F1	30	40	250	142	710	2030	152
SDX 2,6-1	37	50	250	142	710	2130	159
SDX 2,6 2F2E	45	60	250	142	895	2375	258
SDX 2,6-2F2	55	75	250	192	895	2283	291
SDX 2,6-2F1	59	80	250	192	895	2338	299
SDX 2,6-2	66	90	250	192	895	2363	308
SDX 2,6-3F3E	74	100	250	192	1080	2573	481
SDX 2,6-3F2	92	125	250	192	1080	2718	500
SDX 2,6-3	92	125	250	192	1080	2718	500
SDX 2,6-4F4	110	150	250	192	1265	3109	636
SDX 2,6-4	129	175	250	236	1265	2875	705
SDX 2,6-5F5	147	200	250	236	1450	3190	751
SDX 2,6-5F2	147	200	250	236	1450	3190	751
SDX 2,6-6	184	250	250	236	1635	3587	976
SDX 2,6-7	221	300	250	236	1820	3860	1091

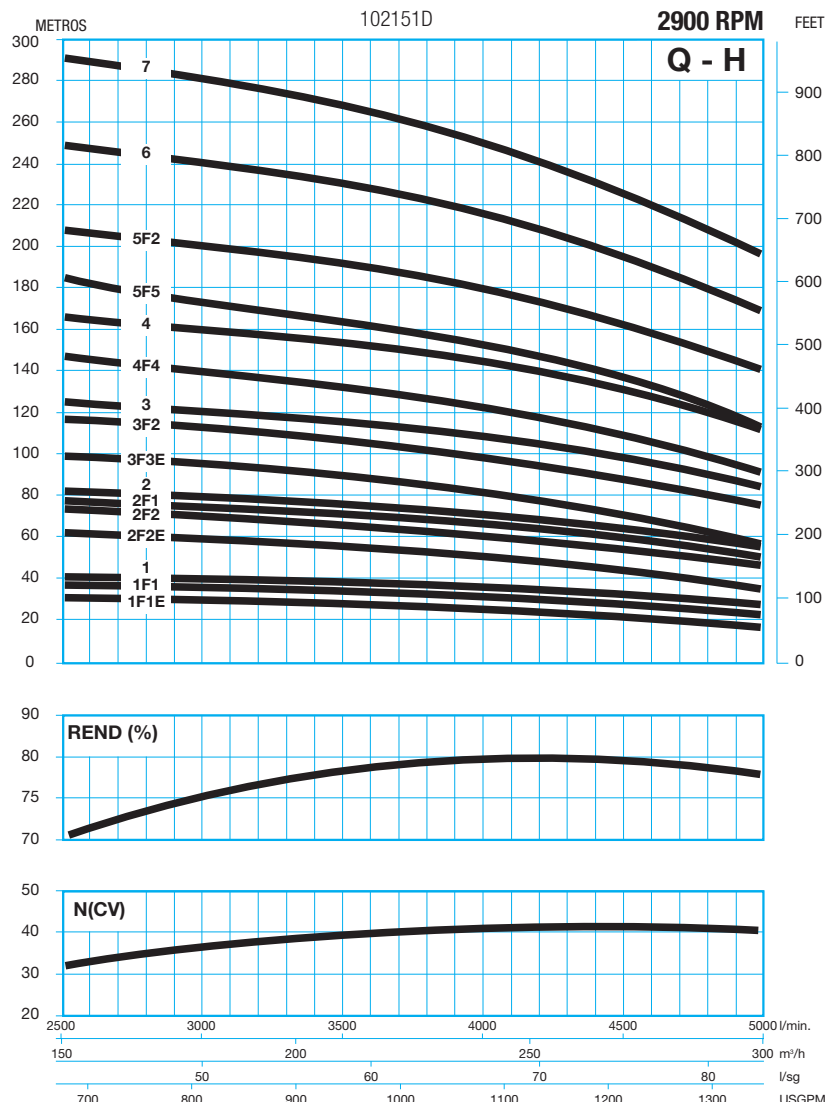

50HZ

BOMBA TIPO: SEMIAXIAL
 TEMP. MAX. LIQUIDO: 25°
 MAX. ARENA: 40 gr/m³
 SENTIDO ROT.: ANTIHORARIO
 VALV. RET.: BAJO PEDIDO

PUMP TYPE: MIXED FLOW
 MAXI. TEMP. LIQUID: 25°
 SAND MAX.: 40 gr/m³
 ROTATION: C.C.W.
 CHECK VAL.: ON REQUEST

POMPE TYPE: SEMIAXIAL
 TEMP. MAX. LIQUIDE: 25°
 MAX. SABLE: 40 gr/m³
 SENS. ROT.: ANTIHORAIRE
 CLAPET RET.: SUR DEMENDE

Tablas de selección / Selection charts / Tables de selection

Tipo Type	Motor - Moteur		l/min. m ³ /h	Caudal - Capacity - Debit					
	KW	HP		0	4000	4500	4750	5250	5500
SD 5 - 1	30	40	m.c.a.	32	26	25	24	21	19
SD 5 - 2	55	75		64	53	50	48	42	38
SD 5 - 3	75	100		96	79	75	72	63	57
SD 5 - 4	110	150		128	106	100	96	84	76
SD 5 - 5	130	175		160	133	125	120	105	95
SD 5 - 6	150	200		192	159	150	144	126	114
SD 5 - 7	185	250		224	186	175	168	147	133
SD 5 - 8	220	300		256	212	200	192	168	152

Dimensiones / Dimensions / Dimensions

Materiales tipo B
 Impulsor: Bronce
 Cuerpo: Hierro fundido
 Eje: Acero inox.

Material type B
 Impeller: Bronze
 Bowl: Cast iron
 Shaft: St. steel

Materiaux type B
 Roue: Bronze
 Corps: Fonte
 Arbre: Acier inox.

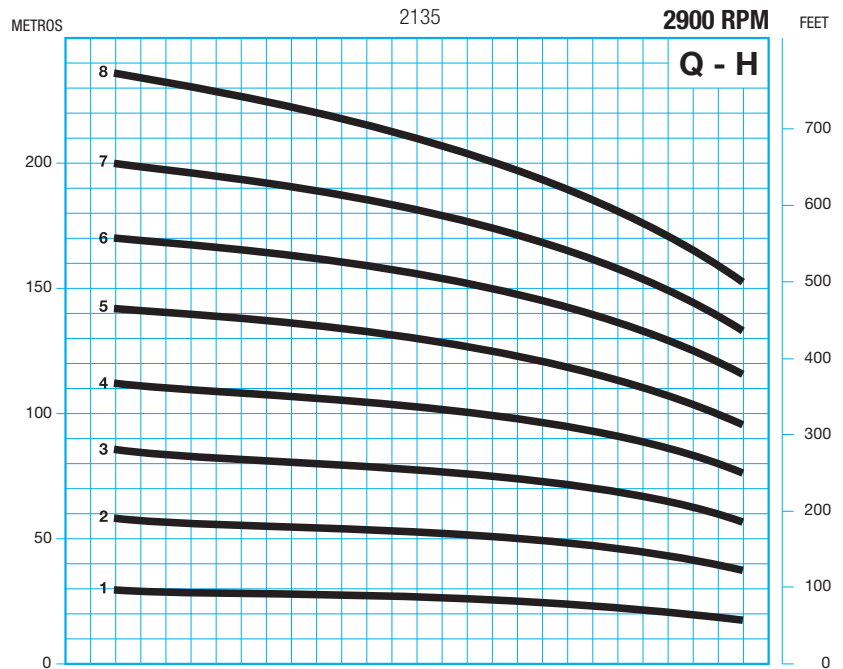
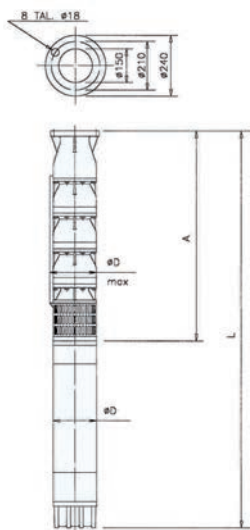

50HZ

Tipo Type	Motor - Moteur		D máx.	D Motor-M	A mm	L mm	Peso Weight Poids (kg)
	KW	HP					
SD 5-1	30	40	240	140	620	1721	196
SD 5-2	55	75	240	192	775	2095	329
SD 5-3	75	100	240	192	868	2418	388
SD 5-4	110	150	260	192	1150	2994	558
SD 5-5	130	175	260	236	1305	3145	629
SD 5-6	150	200	260	236	1460	3430	690
SD 5-7	185	250	280	276	1615	3203	792
SD 5-8	220	300	280	279	1770	3508	873

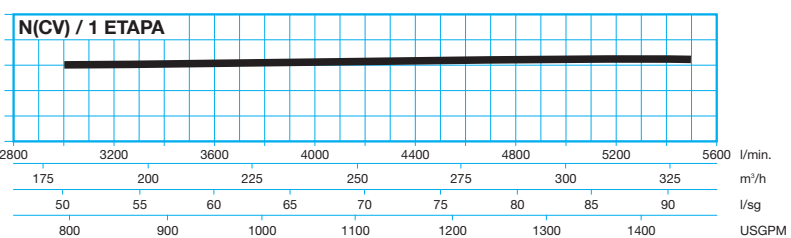
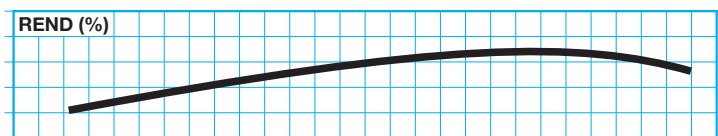

BOMBA TIPO: SEMIAXIAL
 TEMP. MAX. LIQUIDO: 25°
 MAX. ARENA: 40 gr/m³
 SENTIDO ROT.: ANTIHORARIO
 VALV. RET.: BAJO PEDIDO

PUMP TYPE: MIXED FLOW
 MAXI. TEMP. LIQUID: 25°
 SAND MAX.: 40 gr/m³
 ROTATION: C.C.W.
 CHECK VAL.: ON REQUEST

POMPE TYPE: SEMIAXIAL
 TEMP. MAX. LIQUIDE: 25°
 MAX. SABLE: 40 gr/m³
 SENS. ROT.: ANTIHORAIRE
 CLAPET RET.: SUR DEMENDE

Tablas de selección / Selection charts / Tables de selection

Tipo Type	Motor - Moteur		l/min. m ³ /h	Caudal - Capacity - Debit				
	KW	HP		4200	4800	5400	6000	6600
				252	288	324	360	396
SD 6E - 1	30	40	m.c.a.	29	27	25	21	18
SD 6E - 2F1	55	75		50	48	42	32	22
SD 6E - 2	75	100		58	55	51	44	35
SD 6E - 3F1	110	150		82	80	73	60	45
SD 6E - 3	110	150		94	92	86	76	63
SD 6E - 4	150	200		120	120	115	93	72

Dimensiones / Dimensions / Dimensions

Materiales tipo B
 Impulsor: Bronce
 Cuerpo: Hierro fundido
 Eje: Acero inox.

Material type B
 Impeller: Bronze
 Bowl: Cast iron
 Shaft: St. steel

Matériaux type B
 Roue: Bronze
 Corps: Fonte
 Arbre: Acier inox.

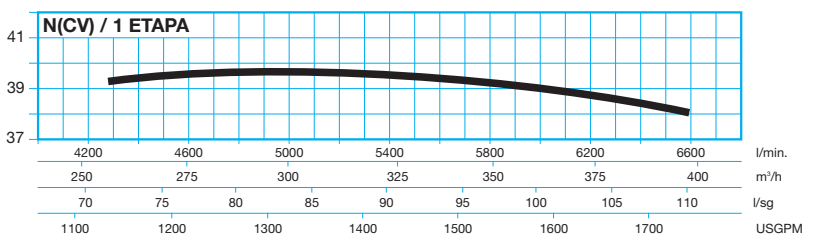
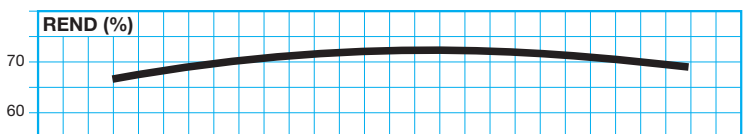
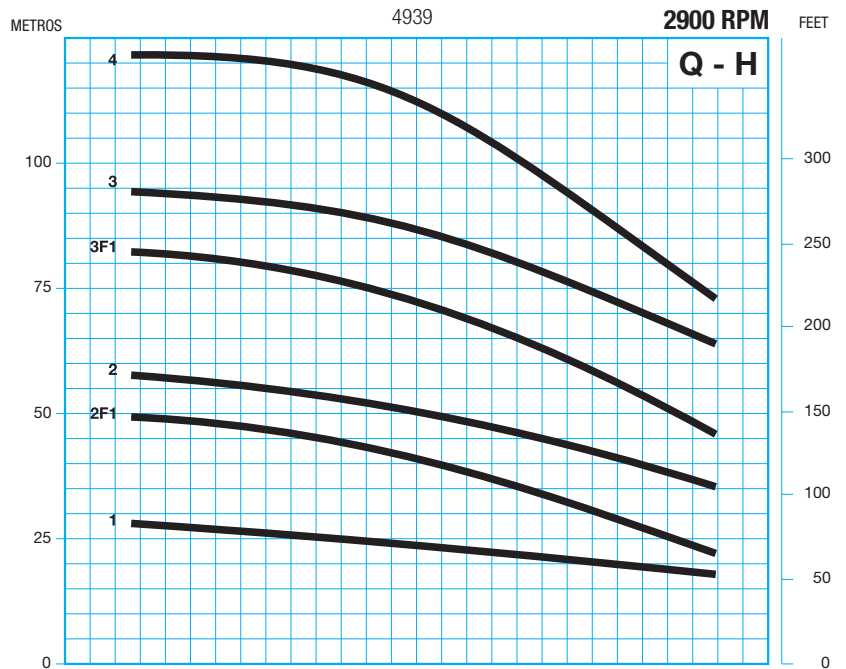
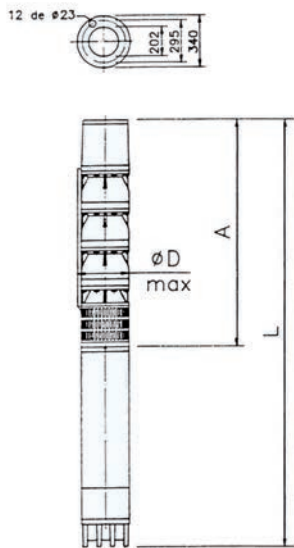

Tipo Type	Motor - Moteur		D máx.	D Motor-M	A mm	L mm	Peso Weight Poids (kg)
	KW	HP					
SD 6E-1	30	40	340	192	755	1856	201
SD 6E-2F1	55	75	340	192	969	2289	300
SD 6E-2	75	100	340	192	969	2289	300
SD 6E-3F1	110	150	348	192	1188	3032	495
SD 6E-3	110	150	348	192	1188	3032	525
SD 6E-4	150	200	348	236	1402	3342	590

BOMBA TIPO: SEMIAXIAL
 TEMP. MAX. LIQUIDO: 25°
 MAX. ARENA: 40 gr/m³
 SENTIDO ROT.: ANTIHORARIO
 VALV. RET.: BAJO PEDIDO

PUMP TYPE: MIXED FLOW
 MAXI. TEMP. LIQUID: 25°
 SAND MAX.: 40 gr/m³
 ROTATION: C.C.W.
 CHECK VAL.: ON REQUEST

POMPE TYPE: SEMIAXIAL
 TEMP. MAX. LIQUIDE: 25°
 MAX. SABLE: 40 gr/m³
 SENS. ROT.: ANTIHORAIRE
 CLAPET RET.: SUR DEMENDE

Tablas de selección / Selection charts / Tables de selection

Tipo Type	Motor - Moteur		l/min. m ³ /h	Caudal - Capacity - Debit					
	KW	HP		0	6500	7000	8000	9000	10000
				0	390	420	480	540	600
SD 9 - 1	55	75	m.c.a.	40	35	34	30	26	21
SD 9 - 2F1	92	125		72	62	60	52	44	34
SD 9 - 2	110	150		80	70	68	60	52	42
SD 9 - 3F1	150	200		112	97	94	82	70	55
SD 9 - 3	185	250		120	105	102	90	78	63
SD 9 - 4	220	300		160	140	136	120	104	85

Dimensiones / Dimensions / Dimensions

Materiales tipo B
 Impulsor: Bronce
 Cuerpo: Hierro fundido
 Eje: Acero inox.

Material type B
 Impeller: Bronze
 Bowl: Cast iron
 Shaft: St. steel

Materiaux type B
 Roue: Bronze
 Corps: Fonte
 Arbre: Acier inox.

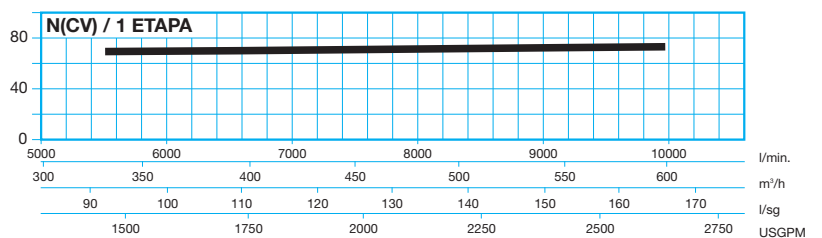
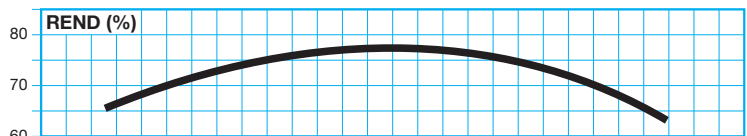
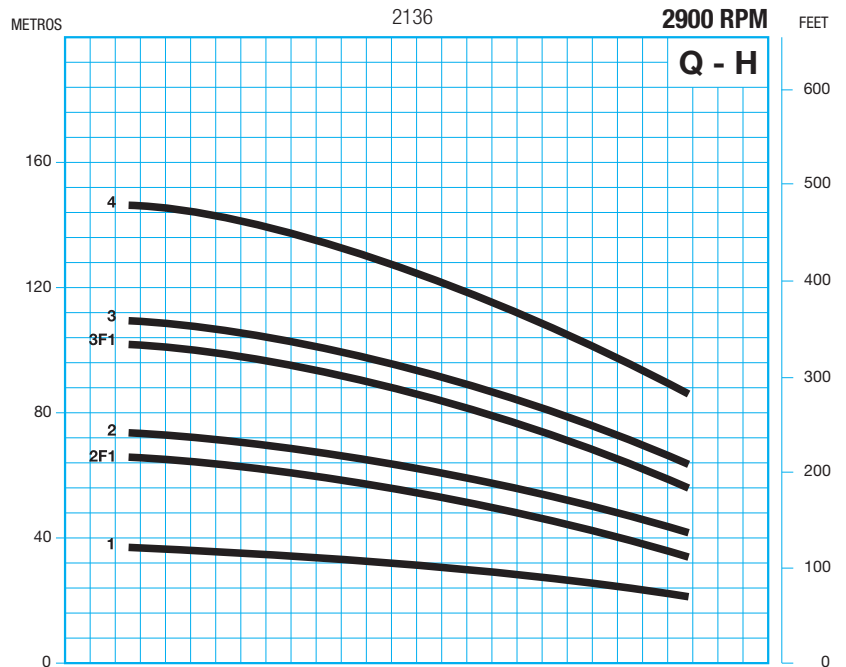
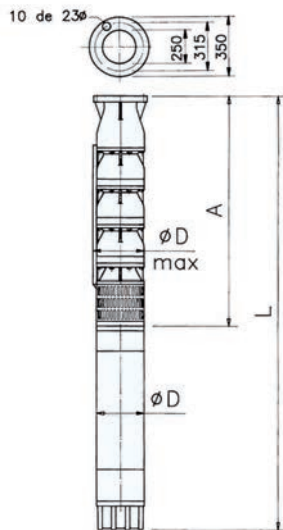

Tipo Type	Motor - Moteur		D máx.	D Motor-M	A mm	L mm	Peso Weight Poids (kg)
	KW	HP					
SD 9-1	55	75	365	192	887	2177	350
SD 9-2F1	92	125	370	192	1127	2971	550
SD 9-2	110	150	380	192	1127	2971	585
SD 9-3F1	150	200	380	236	1367	3337	723
SD 9-3	185	250	380	276	1367	2955	804
SD 9-4	220	300	380	276	1607	3345	912

BOMBA TIPO: RADIAL
 TEMP. MAX. LIQUIDO: 30°
 MAX. ARENA: 200 gr/m³
 SENTIDO ROT.: ANTIHORARIO
 VALV. RET.: INCORPORADA

PUMP TYPE: RADIAL
 MAXI. TEMP. LIQUID: 30°
 SAND MAX.: 200 gr/m³
 ROTATION: C.C.W.
 CHECK VAL.: BUILT-IN

POMPE TYPE: RADIALE
 TEMP. MAX. LIQUIDE: 30°
 MAX. SABLE: 200 gr/m³
 SENS. ROT.: ANTIHORAIRE
 CLAPET RET.: INCORPORÉ

Tablas de selección / Selection charts / Tables de selection

Tipo Type	Motor - Moteur		l/min. m³/h	Caudal - Capacity - Debit							
	KW	HP		0	13,3	26,7	40	53,31	66,7	80	83,3
SJI 4	0,37	0,5	m.c.a.	47	46	44	40	34	25	15	12
SJI 5	0,55	0,75		59	58	55	50	42	32	19	15
SJI 7	0,75	1		82	81	77	70	59	44	25	20
SJI 10	1,1	1,5		117	115	110	100	84	63	38	31
SJI 12	1,5	2		140	139	133	120	101	75	44	37
SJI 16	2,2	3		187	185	175	160	133	101	58	49
SJI 22	3	4		247	244	233	209	175	129	73	53
SJI 27	3,7	5		306	302	288	259	216	161	92	74
SJI 30	4	5,5		335	331	316	284	237	175	99	78

Dimensiones / Dimensions / Dimensions

Materiales tipo A
 Impulsor: Noryl
 Difusor: Noryl
 Eje: Acero inox.
 Camisa: Acero inox.

Material type A
 Impeller: Noryl
 Diffuser: Noryl
 Shaft: St. steel
 Shell: St. steel

Materiaux type A
 Roue: Noryl
 Diffuseur: Noryl
 Arbre: Acier inox.
 Chemise: Acier inox.

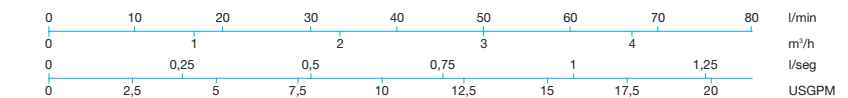
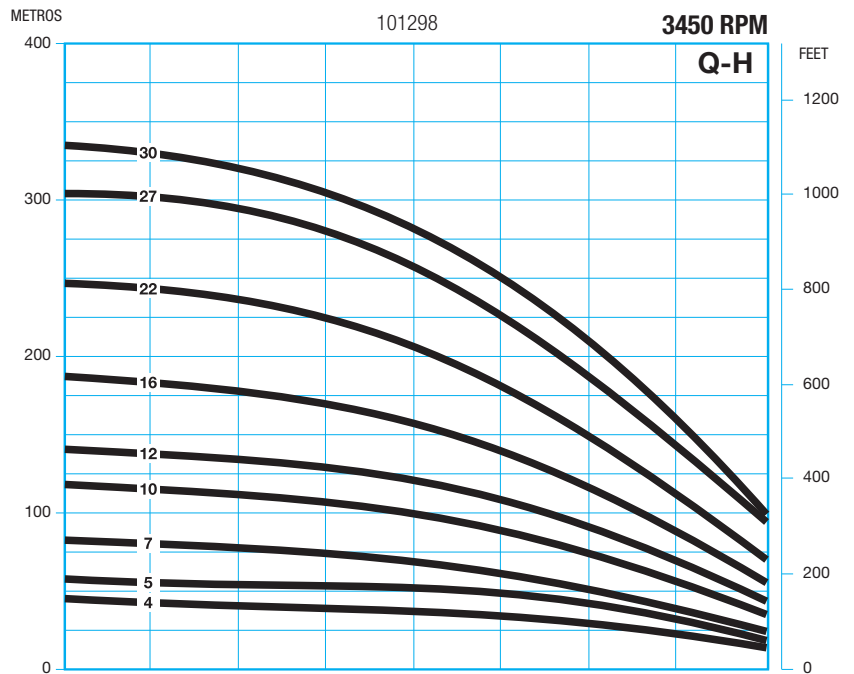
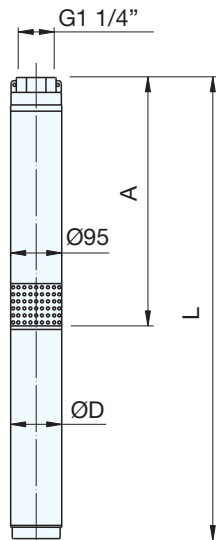

Tipo Type	Motor - Moteur		D mm	A mm	L mm	Peso Weight Poids (kg)
	KW	HP				
SJI 4	0,37	0,5	100	341	671	11
SJI 5	0,55	0,75	100	366	712	12,4
SJI 7	0,75	1	100	417	782	14,2
SJI 10	1,1	1,5	100	497	877	15,9
SJI 12	1,5	2	100	548	953	18,4
SJI 16	2,2	3	100	651	1091	22,2
SJI 22	3	4	100	806	1413	30,2
SJI 27	3,7	5	100	955	1562	41,2
SJI 30	4	5,5	100	1062	1669	43

BOMBA TIPO: RADIAL
 TEMP. MAX. LIQUIDO: 30°
 MAX. ARENA: 200 gr/m³
 SENTIDO ROT.: ANTIHORARIO
 VALV. RET.: INCORPORADA

PUMP TYPE: RADIAL
 MAXI. TEMP. LIQUID: 30°
 SAND MAX.: 200 gr/m³
 ROTATION: C.C.W.
 CHECK VAL.: BUILT-IN

POMPE TYPE: RADIALE
 TEMP. MAX. LIQUIDE: 30°
 MAX. SABLE: 200 gr/m³
 SENS. ROT.: ANTIHORAIRE
 CLAPET RET.: INCORPORÉ

Tablas de selección / Selection charts / Tables de selection

Tipo Type	Motor - Moteur		l/min. m³/h	Caudal - Capacity - Debit							
	KW	HP		0	50	60	70	80	90	100	110
				0	3	3,6	4,2	4,8	5,4	6	6,6
SKI 3	0,37	0,5	m.c.a.	33	30	29	28	26	24	21	18
SKI 4	0,55	0,75		43	40	39	37	34	31	28	23
SKI 5	0,75	1		54	50	49	46	43	39	35	29
SKI 6	1,1	1,5		65	61	58	55	52	47	42	35
SKI 8	1,5	2		87	81	78	74	69	63	55	47
SKI 12	2,2	3		130	121	116	111	103	90	83	68
SKI 16	3	4		174	161	155	147	137	125	111	94
SKI 20	3,7	5		217	202	194	184	172	157	139	117
SKI 22	4	5,5		239	222	214	203	189	172	152	129
SKI 30	5,5	7,5		320	303	291	275	258	235	208	176

Dimensiones / Dimensions / Dimensions

Materiales tipo A
 Impulsor: Noryl
 Difusor: Noryl
 Eje: Acero inox.
 Camisa: Acero inox.

Material type A
 Impeller: Noryl
 Diffuser: Noryl
 Shaft: St. steel
 Shell: St. steel

Materiaux type A
 Roue: Noryl
 Diffuseur: Noryl
 Arbre: Acier inox.
 Chemise: Acier inox.

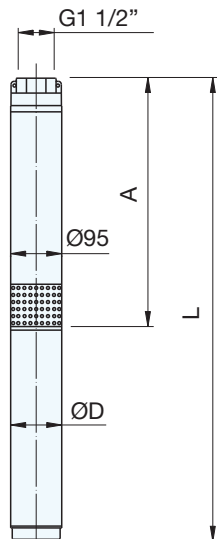

Tipo Type	Motor - Moteur		D mm	A mm	L mm	Peso Weight Poids (kg)
	KW	HP				
SKI 3	0,37	0,5	100	343	673	10,9
SKI 4	0,55	0,75	100	368	714	12,4
SKI 5	0,75	1	100	393	758	14,2
SKI 6	1,1	1,5	100	418	798	15,9
SKI 8	1,5	2	100	468	873	18,4
SKI 12	2,2	3	100	568	1008	22,4
SKI 16	3	4	100	691	1298	30,2
SKI 20	3,7	5	100	843	1450	41,2
SKI 22	4	5,5	100	871	1554	43
SKI 30	5,5	7,5	100	1128	1911	44,5

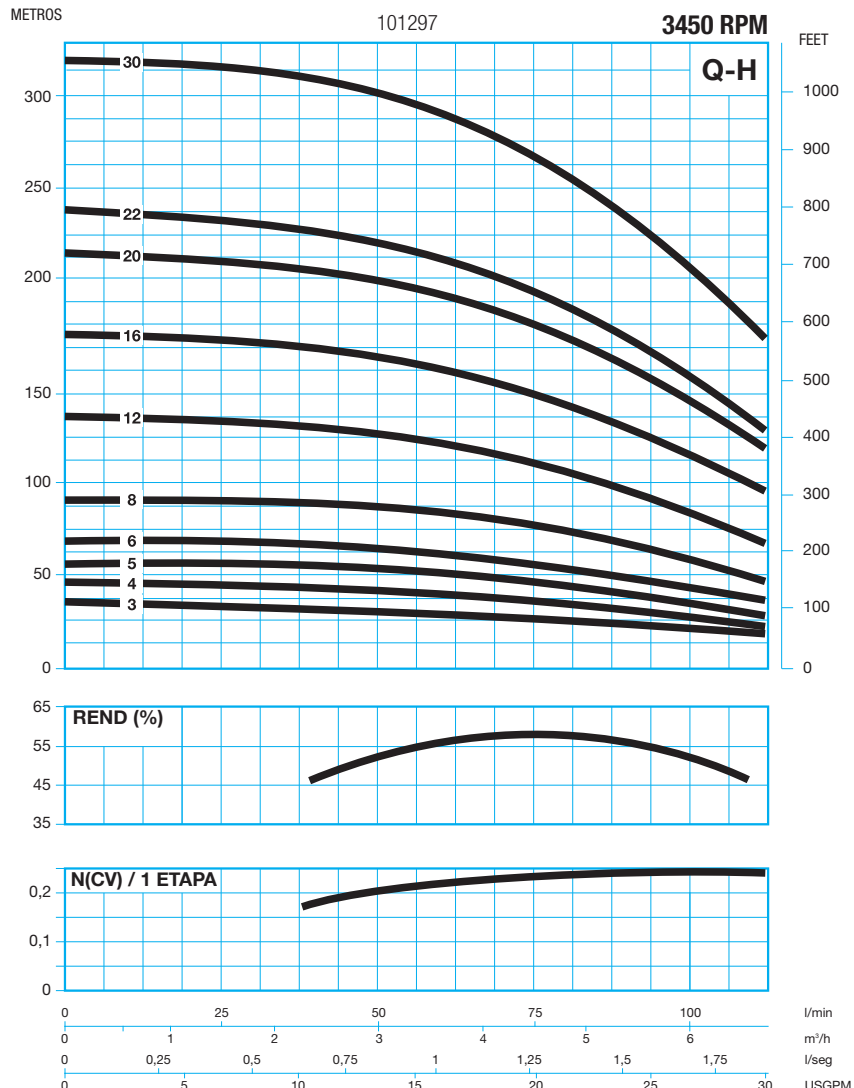

60HZ

BOMBA TIPO: RADIAL
 TEMP. MAX. LIQUIDO: 30°
 MAX. ARENA: 200 gr/m³
 SENTIDO ROT.: ANTIHORARIO
 VALV. RET.: INCORPORADA

PUMP TYPE: RADIAL
 MAXI. TEMP. LIQUID: 30°
 SAND MAX.: 200 gr/m³
 ROTATION: C.C.W.
 CHECK VAL.: BUILT-IN

POMPE TYPE: RADIALE
 TEMP. MAX. LIQUIDE: 30°
 MAX. SABLE: 200 gr/m³
 SENS. ROT.: ANTIHORAIRE
 CLAPET RET.: INCORPORÉ

Tablas de selección / Selection charts / Tables de selection

Tipo Type	Motor - Moteur		l/min. m³/h	Caudal - Capacity - Debit							
	KW	HP		0	40	60	80	100	120	140	160
				0	2,4	3,6	4,8	6	7,2	8,4	9,6
SLI 3	0,55	0,75	m.c.a.	31	30	29	27	24	20	13	3
SLI 4	0,75	1		40	39	39	36	32	26	16	6
SLI 6	1,1	1,5		60	59	58	54	48	38	23	8
SLI 8	1,5	2		81	80	77	73	65	52	35	13
SLI 11	2,2	3		111	109	106	100	89	72	48	18
SLI 15	3	4		151	148	145	136	121	98	66	25
SLI 18	3,7	5		181	179	174	163	145	118	79	30
SLI 20	4	5,5		202	199	193	181	161	131	88	33
SLI 26	5,5	7,5		262	259	251	236	210	170	115	43

Dimensiones / Dimensions / Dimensions

Materiales tipo A
 Impulsor: Noryl
 Difusor: Noryl
 Eje: Acero inox.
 Camisa: Acero inox.

Material type A
 Impeller: Noryl
 Diffuser: Noryl
 Shaft: St. steel
 Shell: St. steel

Materiaux type A
 Roue: Noryl
 Diffuseur: Noryl
 Arbre: Acier inox.
 Chemise: Acier inox.

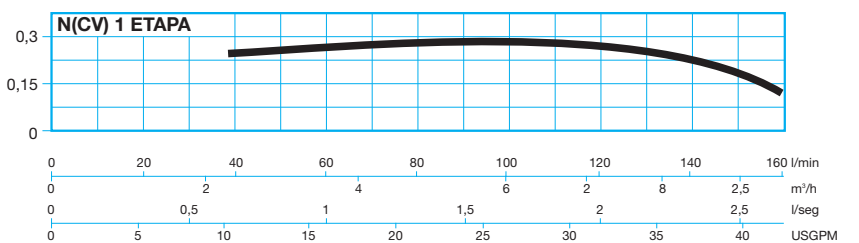
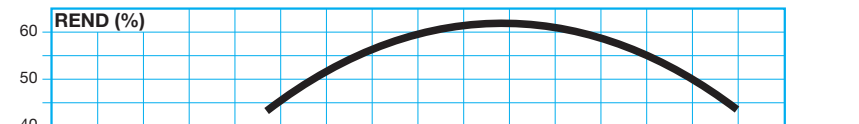
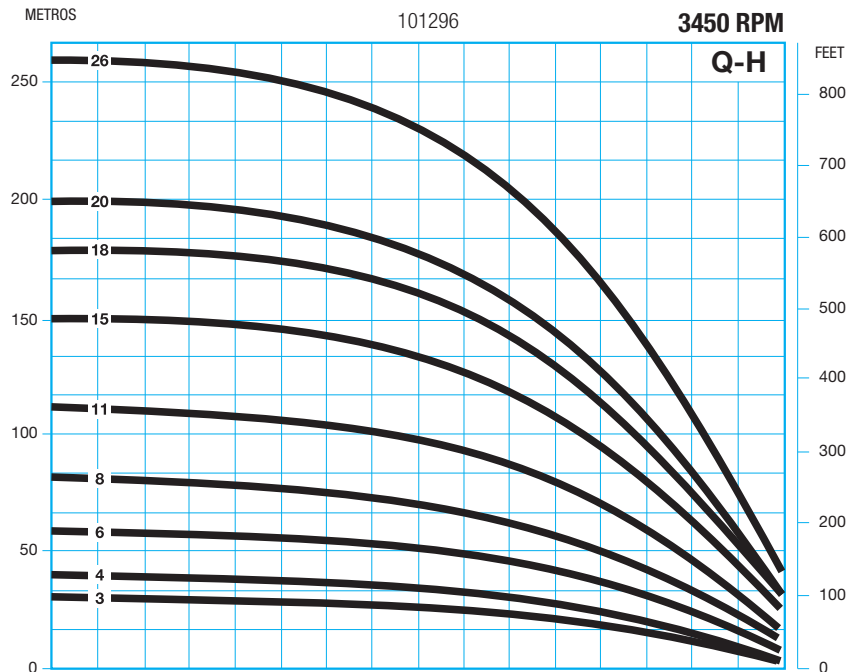
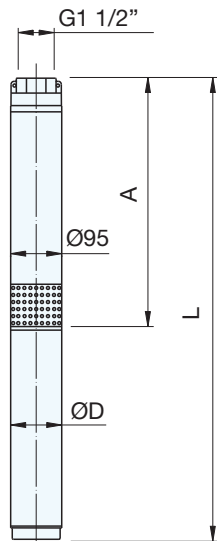

Tipo Type	Motor - Moteur		D mm	A mm	L mm	Peso Weight Poids (kg)
	KW	HP				
SLI 3	0,55	0,75	100	344	374	12,4
SLI 4	0,75	1	100	380	726	14,2
SLI 6	1,1	1,5	100	454	819	15,9
SLI 8	1,5	2	100	572	907	18,4
SLI 11	2,2	3	100	637	1077	22,2
SLI 15	3	4	100	820	1427	30,2
SLI 18	3,7	5	100	857	1464	41,2
SLI 20	4	5,5	100	930	1613	44,7
SLI 26	5,5	7,5	100	1113	1796	64,5

BOMBA TIPO: RADIAL
 TEMP. MAX. LIQUIDO: 30°
 MAX. ARENA: 200 gr/m³
 SENTIDO ROT.: ANTIHORARIO
 VALV. RET.: INCORPORADA

PUMP TYPE: RADIAL
 MAXI. TEMP. LIQUID: 30°
 SAND MAX.: 200 gr/m³
 ROTATION: C.C.W.
 CHECK VAL.: BUILT-IN

POMPE TYPE: RADIALE
 TEMP. MAX. LIQUIDE: 30°
 MAX. SABLE: 200 gr/m³
 SENS. ROT.: ANTIHORAIRE
 CLAPET RET.: INCORPORÉ

Tablas de selección / Selection charts / Tables de selection

Tipo Type	Motor - Moteur		l/min. m³/h	Caudal - Capacity - Debit							
	KW	HP		0	60	100	120	140	160	180	200
				0	3,6	6	7,2	8,4	9,6	10,8	12
SMI 2	0,75	1	m.c.a.	22	20	18	17	16	15	13	11
SMI 3	1,1	1,5		33	29	27	26	24	22	19	16
SMI 4	1,5	2		43	39	36	34	32	29	26	22
SMI 6	2,2	3		65	59	55	52	48	44	39	33
SMI 8	3	4		87	79	73	69	64	59	52	43
SMI 11	3,7	5		119	108	100	95	88	81	71	60
SMI 12	4	5,5		130	118	109	103	96	88	78	65
SMI 15	5,5	7,5		163	147	136	129	121	110	97	81
SMI 22	7,5	10		239	216	200	189	177	161	142	119

Dimensiones / Dimensions / Dimensions

Materiales tipo A
 Impulsor: Noryl
 Difusor: Noryl
 Eje: Acero inox.
 Camisa: Acero inox.

Material type A
 Impeller: Noryl
 Diffuser: Noryl
 Shaft: St. steel
 Shell: St. steel

Materiaux type A
 Roue: Noryl
 Diffuseur: Noryl
 Arbre: Acier inox.
 Chemise: Acier inox.

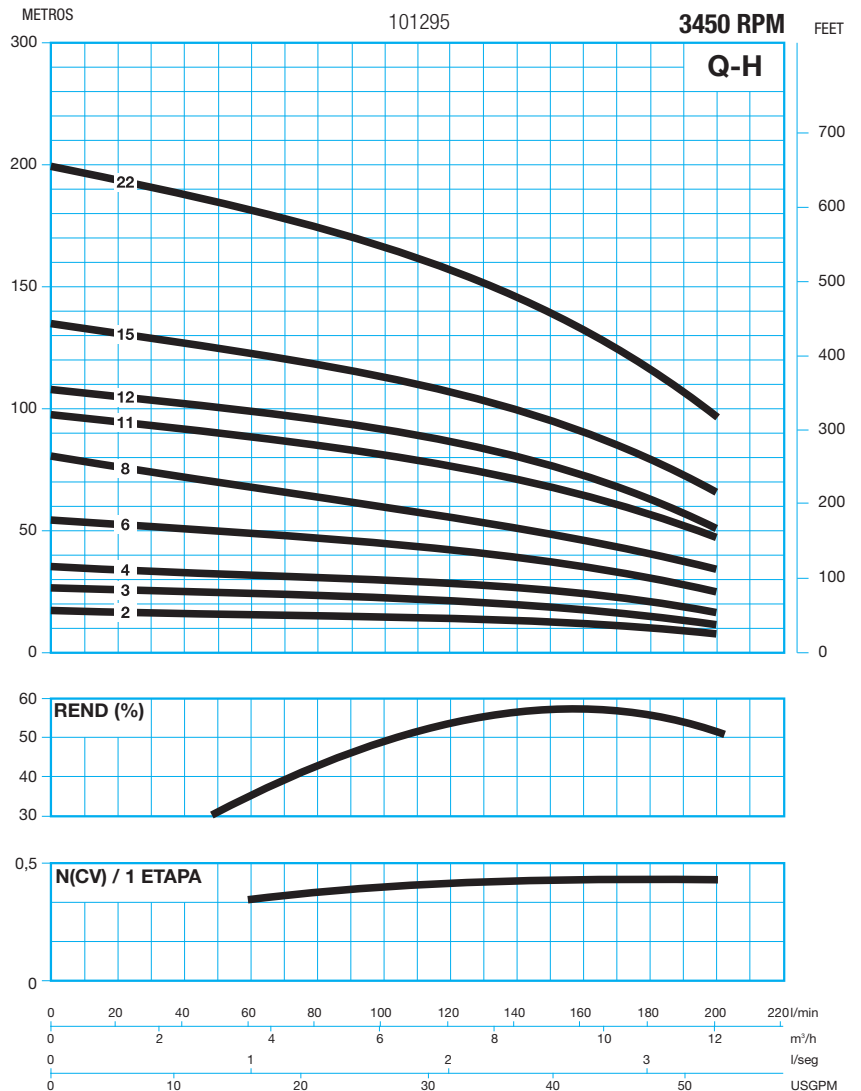
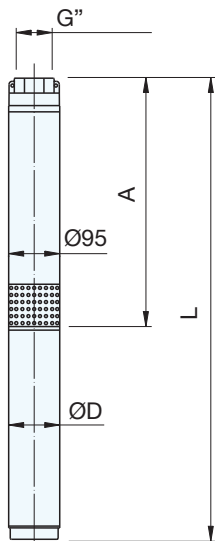

Tipo Type	Motor - Moteur		D mm	A mm	L mm	Peso Weight Poids (kg)
	KW	HP				
SMI 2	0,75	1	100	444	774	11,4
SMI 3	1,1	1,5	100	496	842	15,6
SMI 4	1,5	2	100	548	913	17,5
SMI 6	2,2	3	100	651	1031	18,3
SMI 8	3	4	100	755	1160	21,4
SMI 11	3,7	5	100	909	1516	28,2
SMI 12	4	5,5	100	962	1569	36,4
SMI 15	5,5	7,5	100	1117	1800	45,5
SMI 22	7,5	10	100	1324	2107	64,5

BOMBA TIPO: RADIAL
 TEMP. MAX. LIQUIDO: 30°
 MAX. ARENA: 200 gr/m³
 SENTIDO ROT.: ANTIHORARIO
 VALV. RET.: INCORPORADA

PUMP TYPE: RADIAL
 MAXI. TEMP. LIQUID: 30°
 SAND MAX.: 200 gr/m³
 ROTATION: C.C.W.
 CHECK VAL.: BUILT-IN

POMPE TYPE: RADIALE
 TEMP. MAX. LIQUIDE: 30°
 MAX. SABLE: 200 gr/m³
 SENS. ROT.: ANTIHORAIRE
 CLAPET RET.: INCORPORÉ

Tablas de selección / Selection charts / Tables de selection

Tipo Type	Motor - Moteur		l/min. m³/h	Caudal - Capacity - Debit						
	KW	HP		0	50	100	150	200	250	300
				0	3	6	9	12	15	18
SPI 2	0,75	1	m.c.a.	16	15	14	13	11	10	8
SPI 3	1,1	1,5		25	23	21	19	17	15	12
SPI 4	1,5	2		33	30	28	25	23	20	16
SPI 6	2,2	3		49	45	42	38	34	29	24
SPI 8	3	4		65	60	56	51	46	39	32
SPI 10	3,7	5		82	75	70	64	57	49	39
SPI 12	4	5,5		98	90	84	76	68	59	47
SPI 15	5,5	7,5		123	113	104	95	85	74	59
SPI 21	7,5	10		172	158	146	134	120	103	83

Dimensiones / Dimensions / Dimensions

Materiales tipo A
 Impulsor: Noryl
 Difusor: Noryl
 Eje: Acero inox.
 Camisa: Acero inox.

Material type A
 Impeller: Noryl
 Diffuser: Noryl
 Shaft: St. steel
 Shell: St. steel

Materiaux type A
 Roue: Noryl
 Diffuseur: Noryl
 Arbre: Acier inox.
 Chemise: Acier inox.

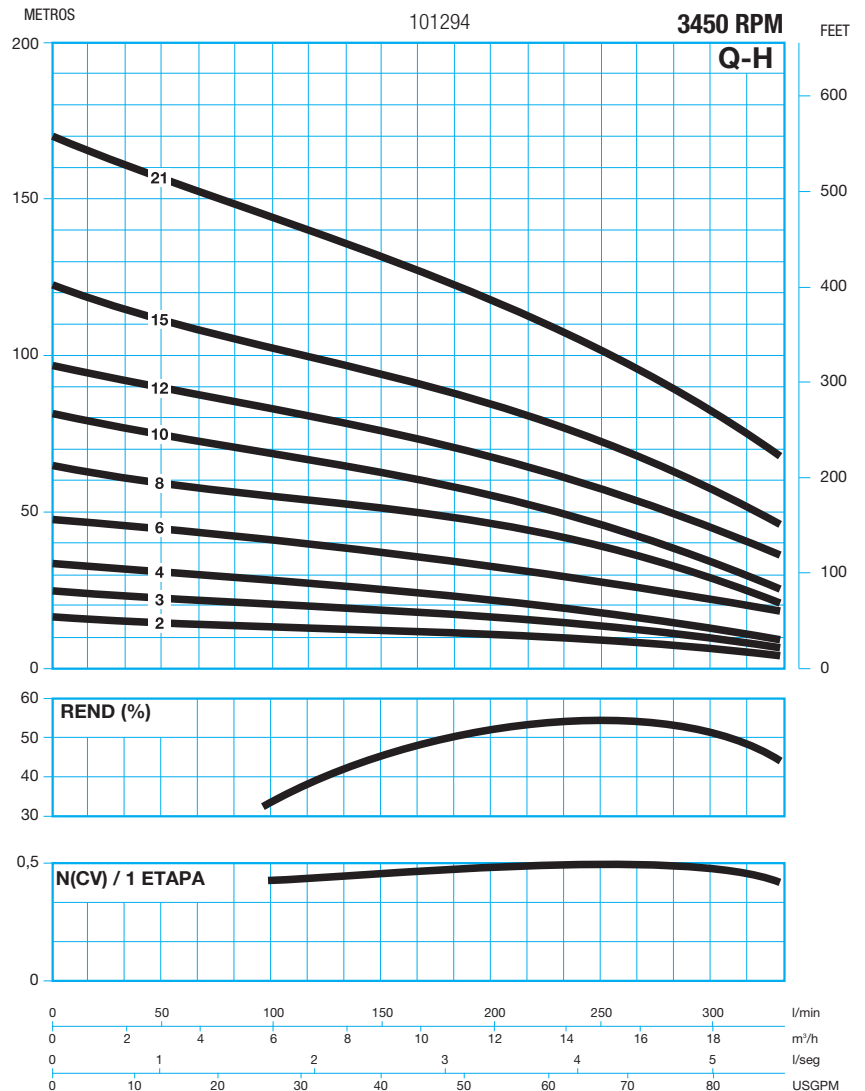
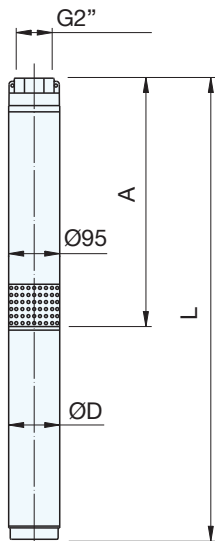

Tipo Type	Motor - Moteur		D mm	A mm	L mm	Peso Weight Poids (kg)
	KW	HP				
SPI 2	0,75	1	100	329	679	11,4
SPI 3	1,1	1,5	100	401	781	15,8
SPI 4	1,5	2	100	473	878	18
SPI 6	2,2	3	100	617	1057	21,2
SPI 8	3	4	100	761	1366	29,3
SPI 10	3,7	5	100	905	1512	35,9
SPI 12	4	5,5	100	1049	1656	35,9
SPI 15	5,5	7,5	100	1265	1948	43,7
SPI 21	7,5	10	100	1697	2480	60,4

BOMBA TIPO: RADIAL
 TEMP. MAX. LIQUIDO: 30°
 MAX. ARENA: 200 gr/m³
 SENTIDO ROT.: ANTIHORARIO
 VALV. RET.: INCORPORADA

PUMP TYPE: RADIAL
 MAXI. TEMP. LIQUID: 30°
 SAND MAX.: 200 gr/m³
 ROTATION: C.C.W.
 CHECK VAL.: BUILT-IN

POMPE TYPE: RADIALE
 TEMP. MAX. LIQUIDE: 30°
 MAX. SABLE: 200 gr/m³
 SENS. ROT.: ANTIHORAIRE
 CLAPET RET.: INCORPORÉ

Tablas de selección / Selection charts / Tables de selection

Tipo Type	Motor - Moteur		l/min. m³/h	Caudal - Capacity - Debit							
	KW	HP		0	100	200	250	300	350	400	450
				0	6	12	15	18	21	24	27
SQI 2	1,1	1,5	m.c.a.	18	16	13	12	10	9	7	5
SQI 3	1,5	2		27	24	20	18	15	13	10	8
SQI 4	2,2	3		36	32	27	24	20	17	14	10
SQI 6	3	4		54	48	40	36	31	26	21	16
SQI 7	3,7	5		63	56	47	42	36	30	24	18
SQI 8	4	5,5		72	64	53	48	41	34	27	21
SQI 10	5,5	7,5		90	80	67	60	51	43	34	26
SQI 14	7,5	10		126	113	94	83	71	60	48	37

Dimensiones / Dimensions / Dimensions

Materiales tipo A
 Impulsor: Noryl
 Difusor: Noryl
 Eje: Acero inox.
 Camisa: Acero inox.

Material type A
 Impeller: Noryl
 Diffuser: Noryl
 Shaft: St. steel
 Shell: St. steel

Materiaux type A
 Roue: Noryl
 Diffuseur: Noryl
 Arbre: Acier inox.
 Chemise: Acier inox.

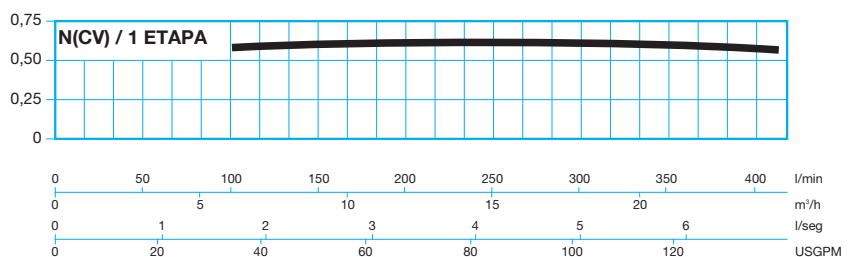
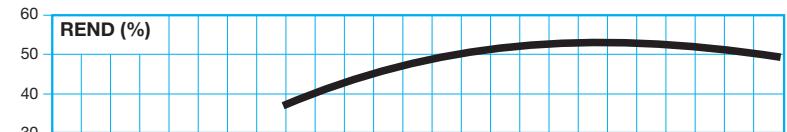
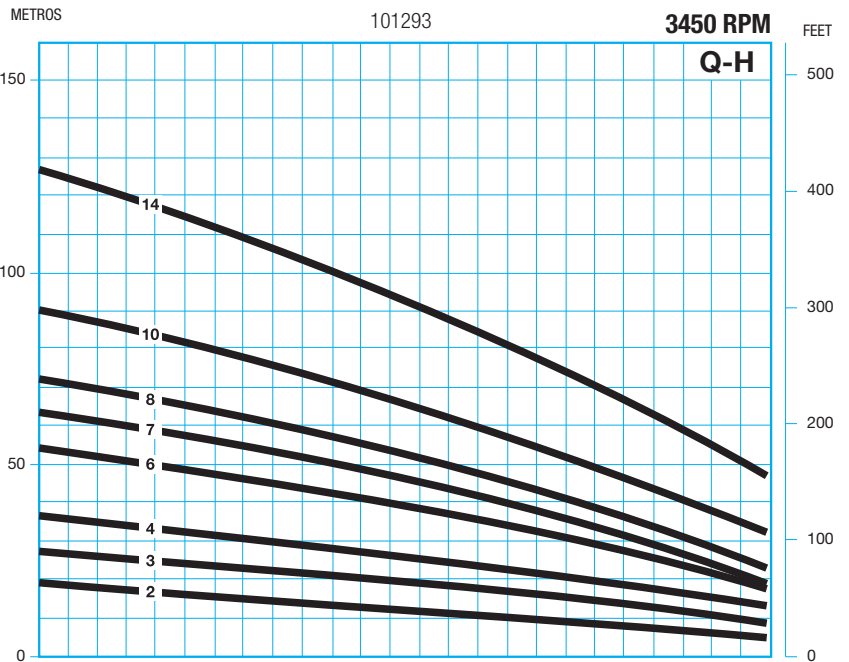
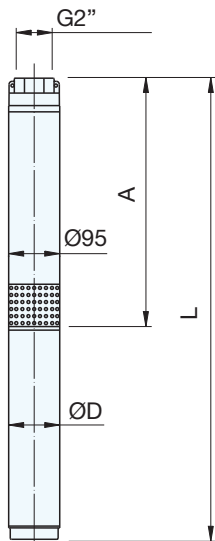

Tipo Type	Motor - Moteur		D mm	A mm	L mm	Peso Weight Poids (kg)
	KW	HP				
SQI 2	1,1	1,5	100	361	741	15,6
SQI 3	1,5	2	100	429	834	18,8
SQI 4	2,2	3	100	497	937	20,2
SQI 6	3	4	100	633	1240	26,2
SQI 7	3,7	5	100	701	1308	31
SQI 8	4	5,5	100	769	1376	33,2
SQI 10	5,5	7,5	100	905	1588	41,3
SQI 14	7,5	10	100	1177	1960	59,3

BOMBA TIPO: RADIAL
 TEMP. MAX. LIQUIDO: 30°
 MAX. ARENA: 50 gr/m³
 SENTIDO ROT.: ANTIHORARIO
 VALV. RET.: INCORPORADA

PUMP TYPE: RADIAL
 MAXI. TEMP. LIQUID: 30°
 SAND MAX.: 50 gr/m³
 ROTATION: C.C.W.
 CHECK VAL.: BUILT-IN

POMPE TYPE: RADIALE
 TEMP. MAX. LIQUIDE: 30°
 MAX. SABLE: 50 gr/m³
 SENS. ROT.: ANTIHORAIRE
 CLAPET RET.: INCORPORÉ

Tablas de selección / Selection charts / Tables de selection

Tipo Type	Motor - Moteur		l/min. m³/h	Caudal - Capacity - Debit					
	KW	HP		0	100	150	200	233	300
STI 0,19 - 1	1,5	2	m.c.a.	24	22	21	19	18	14
STI 0,19 - 2	2,2	3		47	44	41	39	36	27
STI 0,19 - 3	3	4		69	65	62	58	53	41
STI 0,19 - 4	4	5,5		93	88	84	77	71	54
STI 0,19 - 5	5,5	7,5		118	111	105	96	89	68
STI 0,19 - 6	7,5	10		138	131	125	116	107	82
STI 0,19 - 8	9,2	12,5		183	173	167	154	143	109
STI 0,19 - 10	11	15		232	218	210	193	178	138
STI 0,19 - 12	13	18		280	260	251	231	214	163

Dimensiones / Dimensions / Dimensions

Materiales tipo A
 Impulsor: Noryl
 Difusor: Noryl
 Eje: Acero inox.
 Camisa: Acero inox.

Material type A
 Impeller: Noryl
 Diffuser: Noryl
 Shaft: St. steel
 Shell: St. steel

Materiaux type A
 Roue: Noryl
 Diffuseur: Noryl
 Arbre: Acier inox.
 Chemise: Acier inox.

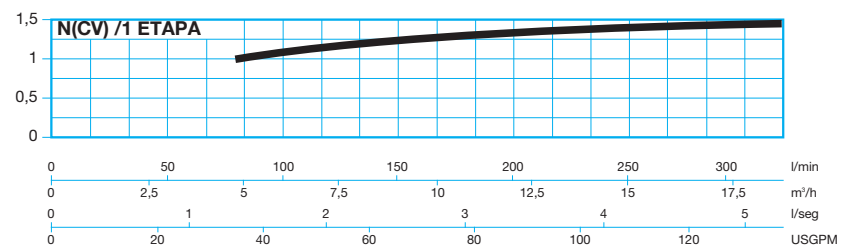
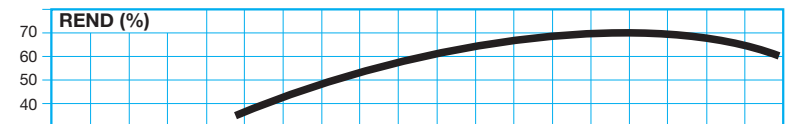
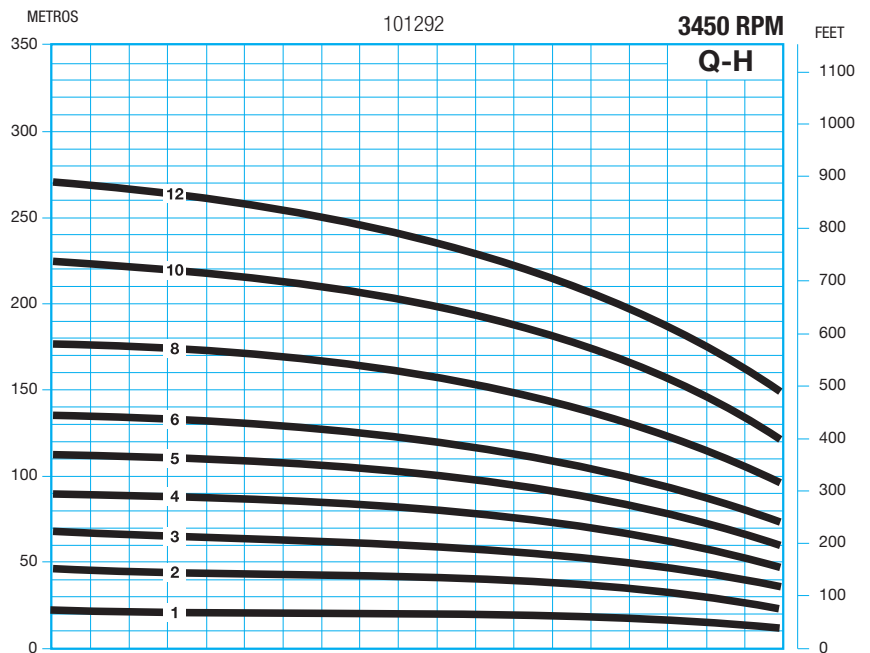
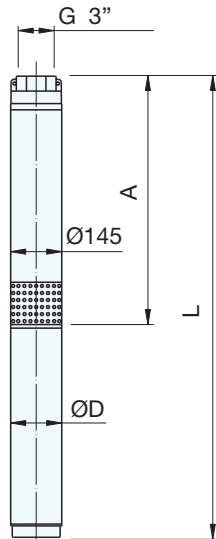

Tipo Type	Motor - Moteur		D mm	A mm	L mm	Peso Weight Poids (kg)
	KW	HP				
STI 0,19-1	1,5	2	95	280	685	15,8
STI 0,19-2	2,2	3	95	340	780	20
STI 0,19-3	3	4	95	400	1007	24,5
STI 0,19-4	4	5,5	95	460	1067	28,7
STI 0,19-5	5,5	7,5	95	520	1203	33,7
STI 0,19-6	7,5	10	145	580	1338	58,4
STI 0,19-8	9,2	12,5	145	700	1500	60,2
STI 0,19-10	11	15	145	810	1661	67,7
STI 0,19-12	13	18	145	930	1833	77,1

BOMBA TIPO: RADIAL
 TEMP. MAX. LIQUIDO: 30°
 MAX. ARENA: 50 gr/m³
 SENTIDO ROT.: ANTIHORARIO
 VALV. RET.: INCORPORADA

PUMP TYPE: RADIAL
 MAXI. TEMP. LIQUID: 30°
 SAND MAX.: 50 gr/m³
 ROTATION: C.C.W.
 CHECK VAL.: BUILT-IN

POMPE TYPE: RADIALE
 TEMP. MAX. LIQUIDE: 30°
 MAX. SABLE: 50 gr/m³
 SENS. ROT.: ANTIHORAIRE
 CLAPET RET.: INCORPORÉ

Tablas de selección / Selection charts / Tables de selection

Tipo Type	Motor - Moteur		l/min. m ³ /h	Caudal - Capacity - Debit					
	KW	HP		0	200	250	300	400	450
STI 0,21 - 2	3	4	m.c.a.	44	39	37	34	27	24
STI 0,21 - 3	4	5,5		66	59	55	52	41	35
STI 0,21 - 4	5,5	7,5		87	77	74	68	55	47
STI 0,21 - 5	7,5	10		108	96	92	83	69	59
STI 0,21 - 7	9,2	12,5		150	135	127	120	96	85
STI 0,21 - 9	11	15		195	176	165	155	124	106
STI 0,21 - 10	13	18		218	193	185	168	137	118
STI 0,21 - 11	15	20		240	215	200	186	151	130
STI 0,21 - 14	18,5	25		310	266	252	235	192	163
STI 0,21 - 16	22	30		355	312	292	275	220	189

Dimensiones / Dimensions / Dimensions

Materiales tipo A
 Impulsor: Noryl
 Difusor: Noryl
 Eje: Acero inox.
 Camisa: Acero inox.

Material type A
 Impeller: Noryl
 Diffuser: Noryl
 Shaft: St. steel
 Shell: St. steel

Materiaux type A
 Roue: Noryl
 Diffuseur: Noryl
 Arbre: Acier inox.
 Chemise: Acier inox.

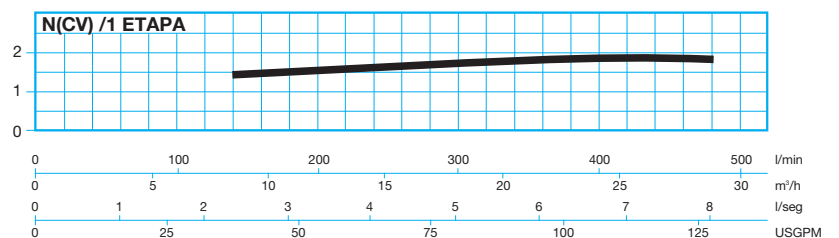
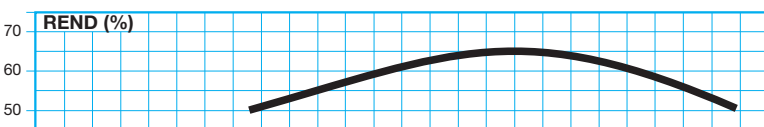
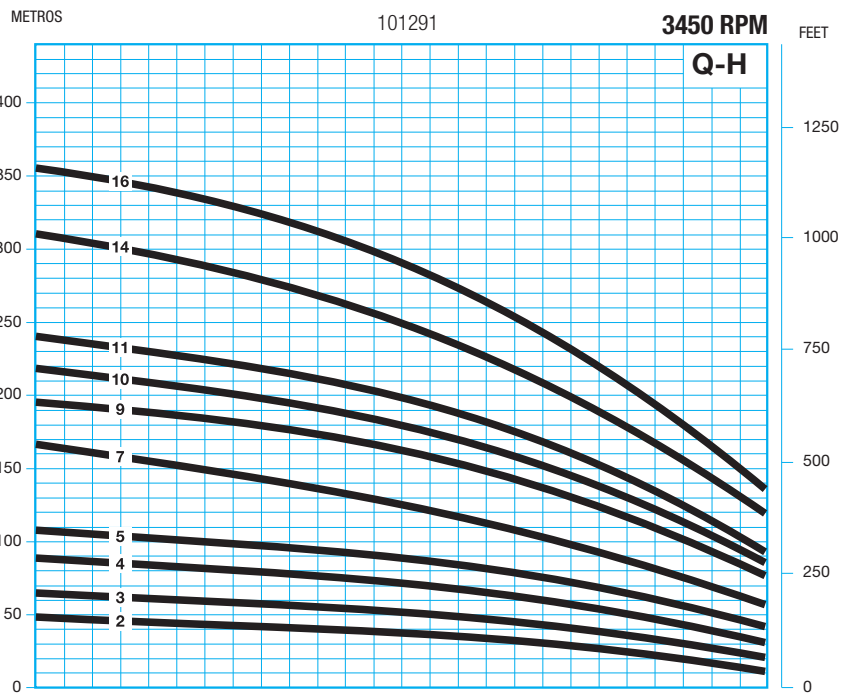
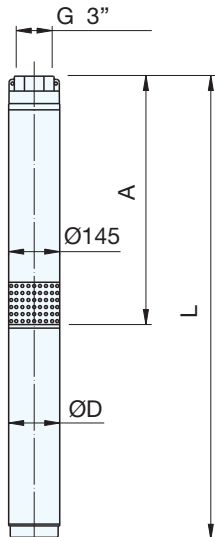

Tipo Type	Motor - Moteur		D mm	A mm	L mm	Peso Weight Poids (kg)
	KW	HP				
STI 0,21-2	3	4	95	495	1102	26,8
STI 0,21-3	4	5,5	95	535	1142	30,3
STI 0,21-4	5,5	7,5	95	580	1263	34,5
STI 0,21-5	7,5	10	145	630	1388	58,5
STI 0,21-7	9,2	12,5	145	720	1520	62,8
STI 0,21-9	11	15	145	815	1666	67,7
STI 0,21-10	13	18	145	860	1771	72,5
STI 0,21-11	15	20	145	905	1878	77,1
STI 0,21-14	18,5	25	145	1045	2051	94,1
STI 0,21-16	22	30	145	1135	2241	101

BOMBA TIPO: RADIAL
 TEMP. MAX. LIQUIDO: 30°
 MAX. ARENA: 50 gr/m³
 SENTIDO ROT.: ANTIHORARIO
 VALV. RET.: INCORPORADA

PUMP TYPE: RADIAL
 MAXI. TEMP. LIQUID: 30°
 SAND MAX.: 50 gr/m³
 ROTATION: C.C.W.
 CHECK VAL.: BUILT-IN

POMPE TYPE: RADIALE
 TEMP. MAX. LIQUIDE: 30°
 MAX. SABLE: 50 gr/m³
 SENS. ROT.: ANTIHORAIRE
 CLAPET RET.: INCORPORÉ

Tablas de selección / Selection charts / Tables de selection

Tipo Type	Motor - Moteur		l/min. m³/h	Caudal - Capacity - Debit						
	KW	HP		0	300	400	500	600	700	800
STI 0,26 - 2	5,5	7,5	m.c.a.	42	40	38	35	32	25	20
STI 0,26 - 3	7,5	10		61	59	56	53	47	40	31
STI 0,26 - 4	11	15		82	80	73	70	62	54	43
STI 0,26 - 5	13	18		105	100	95	88	79	66	53
STI 0,26 - 6	15	20		125	120	114	105	95	81	65
STI 0,26 - 8	18,5	25		168	160	152	141	126	108	87
STI 0,26 - 9	22	30		185	180	168	154	138	120	95
STI 0,26 - 10	26	35		205	195	186	176	155	132	105
STI 0,26 - 12	30	40		248	233	222	206	184	157	124

Dimensiones / Dimensions / Dimensions

Materiales tipo A
 Impulsor: Noryl
 Difusor: Noryl
 Eje: Acero inox.
 Camisa: Acero inox.

Material type A
 Impeller: Noryl
 Diffuser: Noryl
 Shaft: St. steel
 Shell: St. steel

Materiaux type A
 Roue: Noryl
 Diffuseur: Noryl
 Arbre: Acier inox.
 Chemise: Acier inox.

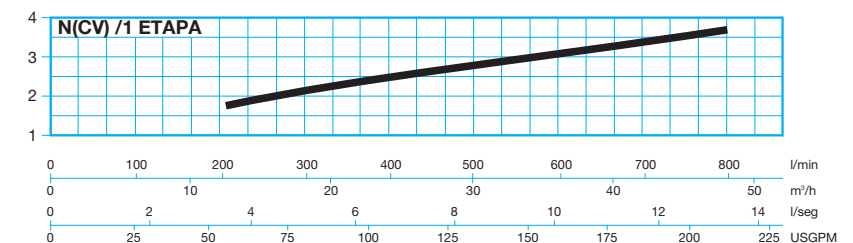
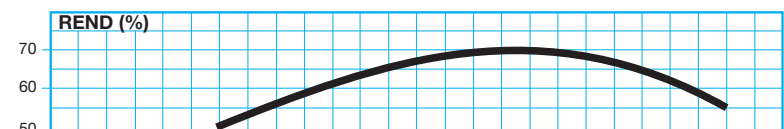
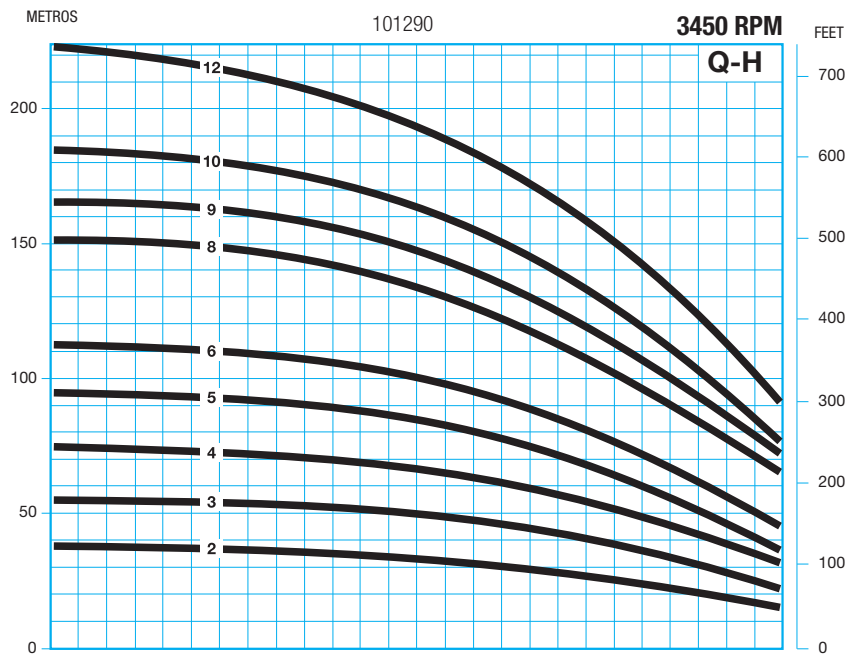
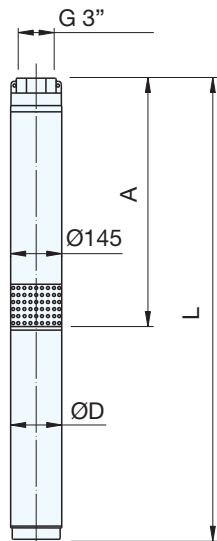

Tipo Type	Motor - Moteur		D mm	A mm	L mm	Peso Weight Poids (kg)
	KW	HP				
STI 0,26-2	5,5	7,5	95	550	1157	33,4
STI 0,26-3	7,5	10	145	615	1298	58,5
STI 0,26-4	11	15	145	680	1480	62,5
STI 0,26-5	13	18	145	745	1656	66,3
STI 0,26-6	15	20	145	810	1783	69,5
STI 0,26-8	18,5	25	145	940	1913	74
STI 0,26-9	22	30	145	1005	2111	87,6
STI 0,26-10	26	35	145	1070	2287	94,4
STI 0,26-12	30	40	145	1135	2382	120

BOMBA TIPO: RADIAL
 TEMP. MAX. LIQUIDO: 30°
 MAX. ARENA: 40 gr/m³
 SENTIDO ROT.: ANTIHORARIO
 VALV. RET.: INCORPORADA

PUMP TYPE: RADIAL
 MAXI. TEMP. LIQUID: 30°
 SAND MAX.: 40 gr/m³
 ROTATION: C.C.W.
 CHECK VAL.: BUILT-IN

POMPE TYPE: RADIALE
 TEMP. MAX. LIQUIDE: 30°
 MAX. SABLE: 40 gr/m³
 SENS. ROT.: ANTIHORAIRE
 CLAPET RET.: INCORPORÉ

Tablas de selección / Selection charts / Tables de selection

Tipo Type	Motor - Moteur		l/min. m ³ /h	Caudal - Capacity - Debit					
	KW	HP		0	35	40	50	60	80
TXI 18/5	0,37	0,5	m.c.a.	47	39	38	36	31	20
TXI 18/9	0,75	1		85	71	70	65	58	39
TXI 18/13	1,1	1,5		123	103	101	94	84	57
TXI 18/17	1,5	2		160	133	129	120	108	70
TXI 18/23	2,2	3		216	177	173	160	143	90
TXI 18/31	3	4		290	239	232	214	193	122
TXI 18/36	3,7	5		337	285	277	256	230	152

Dimensiones / Dimensions / Dimensions

Materiales tipo A
 Impulsor: AISI 304
 Difusor: AISI 304
 Eje: AISI 304

Material type A
 Impeller: AISI 304
 Diffuser: AISI 304
 Shaft: AISI 304

Materiaux type A
 Roue: AISI 304
 Diffuseur: AISI 304
 Arbre: AISI 304

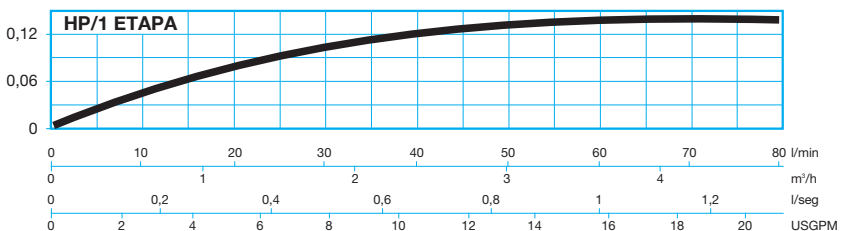
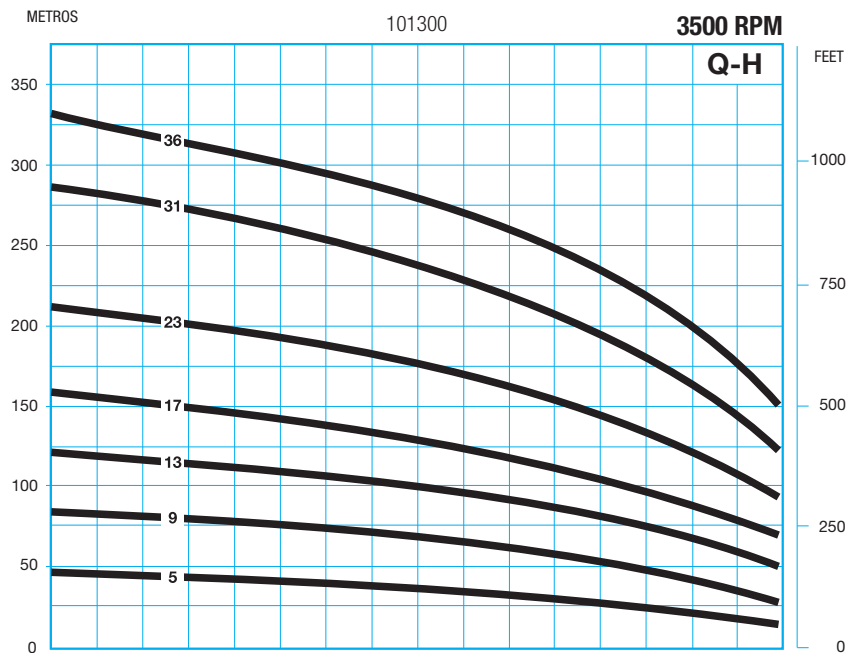
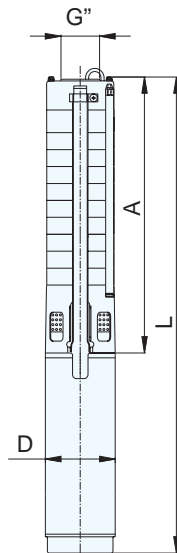

Tipo Type	Motor - Moteur		D mm	A mm	L mm	G"	Peso Weight Poids (kg)
	KW	HP					
TXI 18/5	0,37	0,5	98	270	595	1 1/4"	8,9
TXI 18/9	0,75	1	98	354	679	1 1/4"	10,7
TXI 18/13	1,1	1,5	98	438	823	1 1/4"	12,5
TXI 18/17	1,5	2	98	522	905	1 1/4"	14,9
TXI 18/23	2,2	3	98	648	1066	1 1/4"	16,8
TXI 18/31	3	4	98	816	1284	1 1/4"	20,5
TXI 18/36	3,7	5	98	921	1459	1 1/4"	24,2

BOMBA TIPO: RADIAL
 TEMP. MAX. LIQUIDO: 30°
 MAX. ARENA: 40 gr/m³
 SENTIDO ROT.: ANTIHORARIO
 VALV. RET.: INCORPORADA

PUMP TYPE: RADIAL
 MAXI. TEMP. LIQUID: 30°
 SAND MAX.: 40 gr/m³
 ROTATION: C.C.W.
 CHECK VAL.: BUILT-IN

POMPE TYPE: RADIALE
 TEMP. MAX. LIQUIDE: 30°
 MAX. SABLE: 40 gr/m³
 SENS. ROT.: ANTIHORAIRE
 CLAPET RET.: INCORPORÉ

Tablas de selección / Selection charts / Tables de selection

Tipo Type	Motor - Moteur		l/min. m ³ /h	Caudal - Capacity - Debit					
	KW	HP		0	60	70	80	90	120
TXI 25/4	0,37	0,5	m.c.a.	36	30	28	26	24	17
TXI 25/7	0,75	1		64	52	49	46	42	30
TXI 25/9	1,1	1,5		82	68	63	59	55	40
TXI 25/11	1,5	2		100	83	79	73	69	51
TXI 25/15	2,2	3		136	110	105	98	92	70
TXI 25/21	3	4		190	153	146	137	128	97
TXI 25/26	3,7	5		236	192	183	172	162	121
TXI 25/39	5,5	7,5		348	290	278	262	246	183

Dimensiones / Dimensions / Dimensions

Materiales tipo A
 Impulsor: AISI 304
 Difusor: AISI 304
 Eje: AISI 304

Material type A
 Impeller: AISI 304
 Diffuser: AISI 304
 Shaft: AISI 304

Materiaux type A
 Roue: AISI 304
 Diffuseur: AISI 304
 Arbre: AISI 304

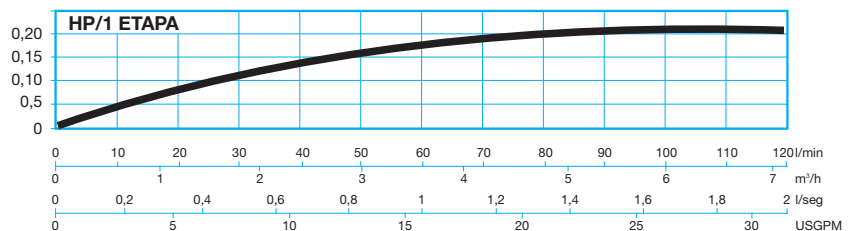
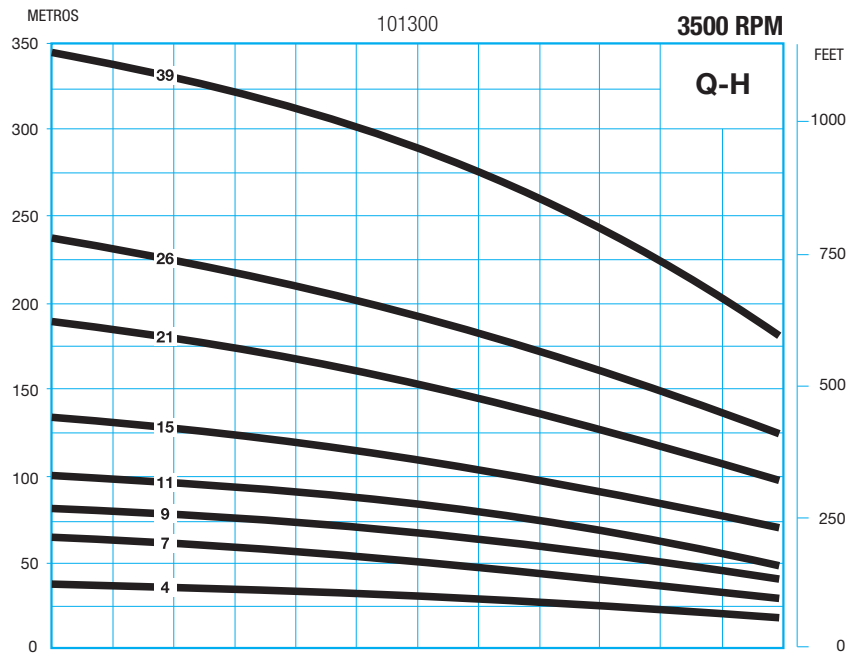
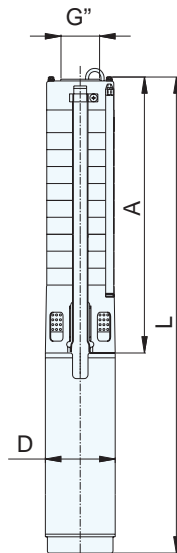

Tipo Type	Motor - Moteur		D mm	A mm	L mm	G"	Peso Weight Poids (kg)
	KW	HP					
TXI 25/4	0,37	0,5	98	249	574	1 1/2"	8,7
TXI 25/7	0,75	1	98	312	637	1 1/2"	10,4
TXI 25/9	1,1	1,5	98	354	679	1 1/2"	11,9
TXI 25/11	1,5	2	98	396	781	1 1/2"	14
TXI 25/15	2,2	3	98	480	863	1 1/2"	15,6
TXI 25/21	3	4	98	606	1024	1 1/2"	18,4
TXI 25/26	3,7	5	98	711	1179	1 1/2"	22,3
TXI 25/39	5,5	7,5	98	984	1522	1 1/2"	29

BOMBA TIPO: RADIAL
 TEMP. MAX. LIQUIDO: 30°
 MAX. ARENA: 40 gr/m³
 SENTIDO ROT.: ANTIHORARIO
 VALV. RET.: INCORPORADA

PUMP TYPE: RADIAL
 MAXI. TEMP. LIQUID: 30°
 SAND MAX.: 40 gr/m³
 ROTATION: C.C.W.
 CHECK VAL.: BUILT-IN

POMPE TYPE: RADIALE
 TEMP. MAX. LIQUIDE: 30°
 MAX. SABLE: 40 gr/m³
 SENS. ROT.: ANTIHORAIRE
 CLAPET RET.: INCORPORÉ

Tablas de selección / Selection charts / Tables de selection

Tipo Type	Motor - Moteur		l/min. m ³ /h	Caudal - Capacity - Debit					
	KW	HP		0	80	90	140	180	200
TXI 40/4	0,75	1	m.c.a.	34	31	30	27	22	18
TXI 40/5	1,1	1,5		43	39	38	34	27	22
TXI 40/7	1,5	2		60	52	51	44	39	32
TXI 40/9	2,2	3		77	64	62	57	49	42
TXI 40/12	3	4		102	90	89	80	70	61
TXI 40/15	3,7	5		129	112	110	99	88	77
TXI 40/25	5,5	7,5		213	183	180	163	142	124
TXI 40/30	7,5	10		255	220	217	197	171	150

Dimensiones / Dimensions / Dimensions

Materiales tipo A
 Impulsor: AISI 304
 Difusor: AISI 304
 Eje: AISI 304

Material type A
 Impeller: AISI 304
 Diffuser: AISI 304
 Shaft: AISI 304

Materiaux type A
 Roue: AISI 304
 Diffuseur: AISI 304
 Arbre: AISI 304

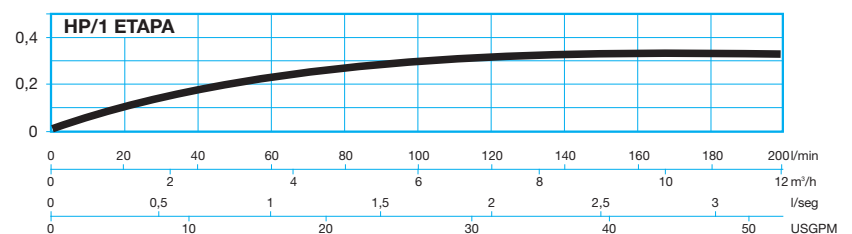
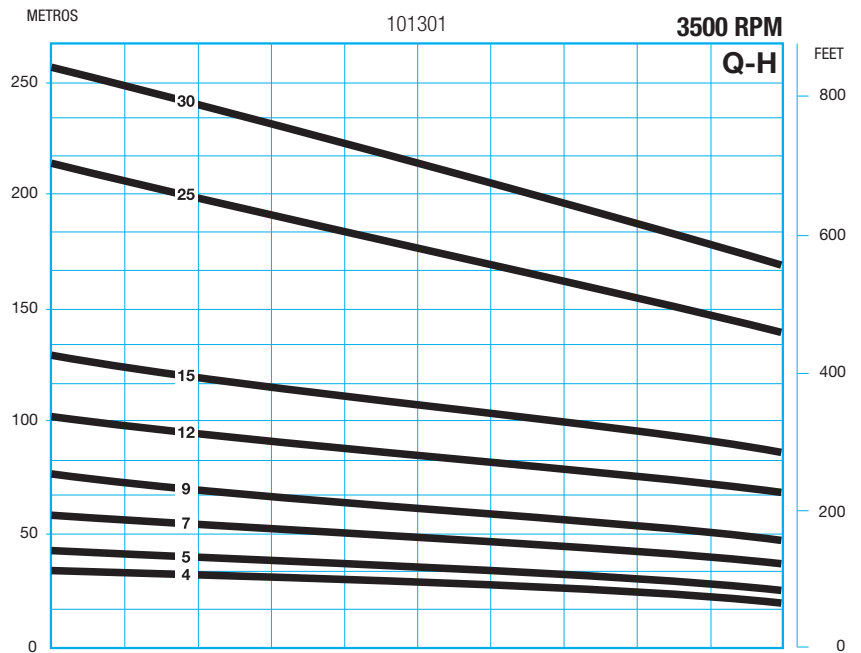
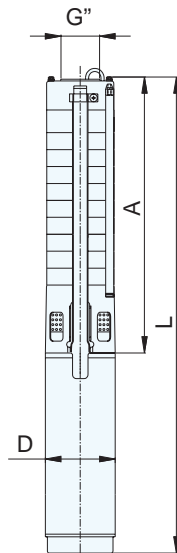

Tipo Type	Motor - Moteur		D mm	A mm	L mm	G"	Peso Weight Poids (kg)
	KW	HP					
TXI 40/4	0,75	1	98	343	668	2"	11,2
TXI 40/5	1,1	1,5	98	385	710	2"	12,8
TXI 40/7	1,5	2	98	469	854	2"	15,5
TXI 40/9	2,2	3	98	553	936	2"	17,3
TXI 40/12	3	4	98	679	1097	2"	20,7
TXI 40/15	3,7	5	98	805	1273	2"	24,7
TXI 40/25	5,5	7,5	98	1225	1763	2"	33
TXI 40/30	7,5	10	98	1435	2245	2"	43,6

60HZ

BOMBA TIPO: RADIAL
 TEMP. MAX. LIQUIDO: 30°
 MAX. ARENA: 40 gr/m³
 SENTIDO ROT.: ANTIHORARIO
 VALV. RET.: INCORPORADA

PUMP TYPE: RADIAL
 MAXI. TEMP. LIQUID: 30°
 SAND MAX.: 40 gr/m³
 ROTATION: C.C.W.
 CHECK VAL.: BUILT-IN

POMPE TYPE: RADIALE
 TEMP. MAX. LIQUIDE: 30°
 MAX. SABLE: 40 gr/m³
 SENS. ROT.: ANTIHORAIRE
 CLAPET RET.: INCORPORÉ

Tablas de selección / Selection charts / Tables de selection

Tipo Type	Motor - Moteur		l/min. m ³ /h	Caudal - Capacity - Debit					
	KW	HP		0	140	180	200	250	350
TXI 75/3	1,5	2	m.c.a.	29	26	25	24	22	13
TXI 75/5	2,2	3		48	41	40	39	37	21
TXI 75/8	3,7	5		77	65	63	62	57	34
TXI 75/12	5,5	7,5		115	100	96	93	84	52
TXI 75/16	7,5	10		154	131	126	123	112	69

Dimensiones / Dimensions / Dimensions

Materiales tipo A
 Impulsor: AISI 304
 Difusor: AISI 304
 Eje: AISI 304

Material type A
 Impeller: AISI 304
 Diffuser: AISI 304
 Shaft: AISI 304

Materiaux type A
 Roue: AISI 304
 Diffuseur: AISI 304
 Arbre: AISI 304

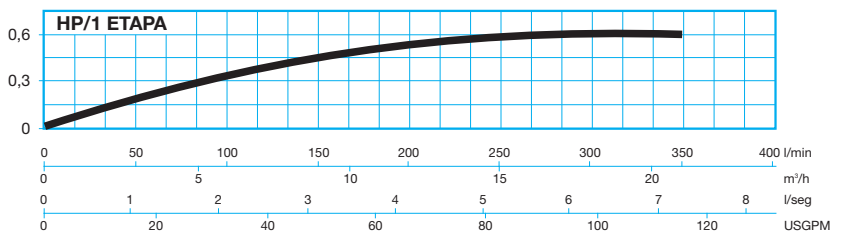
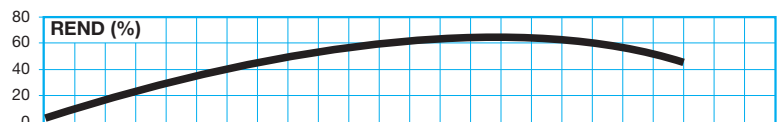
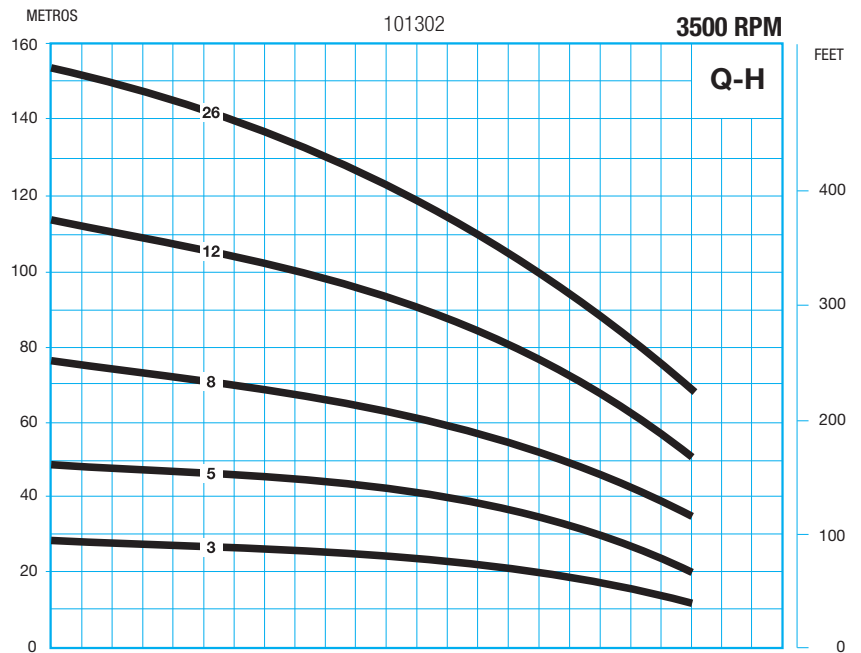
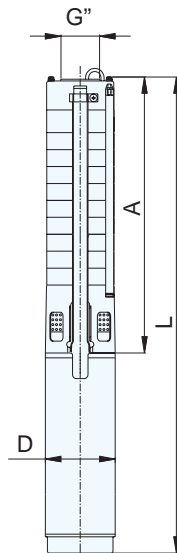

Tipo Type	Motor - Moteur		D mm	A mm	L mm	G"	Peso Weight Poids (kg)
	KW	HP					
TXI 75/3	1,5	2	98	373	758	2"	15
TXI 75/5	2,2	3	98	503	886	2"	17
TXI 75/8	3,7	5	98	698	1166	2"	24
TXI 75/12	5,5	7,5	98	958	1496	2"	29
TXI 75/16	7,5	10	98	1218	2028	2"	40

BOMBA TIPO: RADIAL
 TEMP. MAX. LIQUIDO: 30°
 MAX. ARENA: 50 gr/m³
 SENTIDO ROT.: ANTIHORARIO
 VALV. RET.: INCORPORADA

PUMP TYPE: RADIAL
 MAXI. TEMP. LIQUID: 30°
 SAND MAX.: 50 gr/m³
 ROTATION: C.C.W.
 CHECK VAL.: BUILT-IN

POMPE TYPE: RADIALE
 TEMP. MAX. LIQUIDE: 30°
 MAX. SABLE: 50 gr/m³
 SENS. ROT.: ANTIHORAIRE
 CLAPET RET.: INCORPORÉ

Tablas de selección / Selection charts / Tables de selection

Tipo Type	Motor - Moteur		l/min. m ³ /h	Caudal - Capacity - Debit											
	KW	HP		0	60	90	120	180	240	270	300	330	360	390	420
				0	3,6	5,4	7,2	10,8	14,4	16,2	18	19,8	21,6	23,4	25,2
SXT 10/8	5,5	7,5	m.c.a.	109	109	108	106	98	86	78	68	57	45	31	17
SXT 10/9	7,5	10		122	122	121	119	111	96	87	77	64	50	35	20
SXT 10/10	7,5	10		136	136	135	132	123	107	97	85	71	56	39	22
SXT 10/12	9,3	12,5		163	163	162	159	147	129	116	102	86	67	47	26
SXT 10/14	9,3	12,5		190	190	189	185	172	150	136	119	100	78	55	30
SXT 10/16	11	15		217	218	215	211	197	172	155	136	114	90	63	35
SXT 10/18	13	17,5		244	245	242	238	221	193	175	153	128	101	70	39
SXT 10/19	13	17,5		258	258	256	251	233	204	184	162	135	106	74	41
SXT 10/21	15	20		285	285	283	278	258	225	204	179	150	118	82	46
SXT 10/23	15	20		312	313	310	304	283	247	223	196	164	129	90	50
SXT 10/24	19	25		326	326	323	317	295	257	233	204	171	134	94	52
SXT 10/26	19	25		353	353	350	344	320	279	252	221	185	146	102	56
SXT 10/28	19	25		380	381	377	370	344	300	272	238	200	157	110	61
SXT 10/30	22	30		407	408	404	397	369	322	291	255	214	168	117	65
SXT 10/33	22	30		448	449	444	436	406	354	320	281	235	185	129	72
SXT 10/35	22	30		475	476	471	463	430	375	340	298	250	196	137	76
SXT 10/37	27	35	502	503	498	489	455	397	359	315	264	207	145	80	

Dimensiones / Dimensions / Dimensions

Materiales tipo A
 Impulsor: AISI 304L
 Difusor: AISI 304L
 Eje: AISI 420
 Camisa: AISI 304

Material type A
 Impeller: AISI 304L
 Diffuser: AISI 304L
 Shaft: AISI 420
 Shell: AISI 304

Materiaux type A
 Roue: AISI 304L
 Diffuseur: AISI 304L
 Arbre: AISI 420
 Chemise: AISI 304

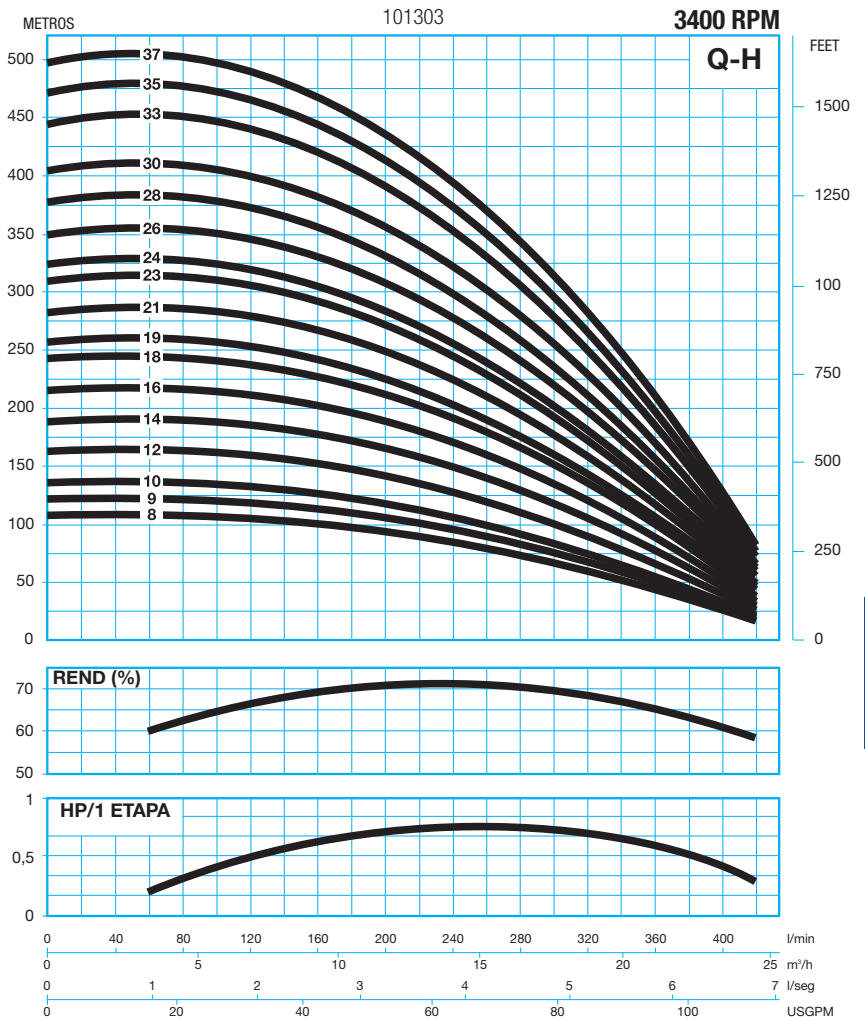
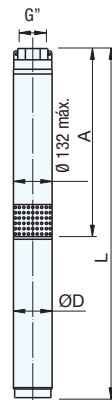

Tipo Type	Motor - Moteur		D mm	A mm	L mm	G"	Peso Weight Poids (kg)
	KW	HP					
SXT 10/8	5,5	7,5	144	746	1424	2 1/2"	62
SXT 10/9	7,5	10	144	806	1564	2 1/2"	70
SXT 10/10	7,5	10	144	868	1626	2 1/2"	71
SXT 10/12	9,3	12,5	144	986	1786	2 1/2"	78
SXT 10/14	9,3	12,5	144	1107	1907	2 1/2"	80
SXT 10/16	11	15	144	1231	2082	2 1/2"	87
SXT 10/18	13	17,5	144	1349	2260	2 1/2"	95
SXT 10/19	13	17,5	144	1407	2318	2 1/2"	96
SXT 10/21	15	20	144	1533	2506	2 1/2"	105
SXT 10/23	15	20	144	1654	2627	2 1/2"	107
SXT 10/24	19	25	144	1715	2721	2 1/2"	109
SXT 10/26	19	25	144	1835	2841	2 1/2"	119
SXT 10/28	19	25	144	1956	2962	2 1/2"	122
SXT 10/30	22	30	144	2075	3181	2 1/2"	131
SXT 10/33	22	30	144	2262	3368	2 1/2"	135
SXT 10/35	22	30	144	2379	3485	2 1/2"	137
SXT 10/37	27	35	144	2501	3718	2 1/2"	144



BOMBA TIPO: RADIAL
 TEMP. MAX. LIQUIDO: 30°
 MAX. ARENA: 50 gr/m³
 SENTIDO ROT.: ANTIHORARIO
 VALV. RET.: INCORPORADA

PUMP TYPE: RADIAL
 MAXI. TEMP. LIQUID: 30°
 SAND MAX.: 50 gr/m³
 ROTATION: C.C.W.
 CHECK VAL.: BUILT-IN

POMPE TYPE: RADIALE
 TEMP. MAX. LIQUIDE: 30°
 MAX. SABLE: 50 gr/m³
 SENS. ROT.: ANTIHORAIRE
 CLAPET RET.: INCORPORÉ

Tablas de selección / Selection charts / Tables de selection

Tipo Type	Motor - Moteur		l/min. m ³ /h	Caudal - Capacity - Debit													
	KW	HP		0	60	120	210	228	246	264	282	300	390	408	480		
				0	3,6	7,2	12,6	13,7	14,8	15,8	16,9	18	13,4	24,5	28,8		
SXT 17/6	7,5	10	m.c.a.	97	97	95	89	87	84	83	80	77	57	53	34		
SXT 17/8	9,3	12,5		129	129	127	119	116	112	110	106	102	76	71	45		
SXT 17/10	11	15		162	161	158	148	145	140	138	133	128	95	89	57		
SXT 17/11	11	15		178	177	174	163	160	154	151	146	140	105	97	62		
SXT 17/13	13	17,5		210	209	206	193	189	182	179	172	166	124	115	74		
SXT 17/15	15	20		243	241	238	223	218	210	206	199	192	143	133	85		
SXT 17/17	19	25		275	273	269	252	247	238	234	225	217	162	151	97		
SXT 17/18	19	25		291	290	285	267	261	252	248	239	230	171	159	102		
SXT 17/20	22	30		323	322	317	297	290	280	275	265	255	190	177	114		
SXT 17/24	27	35		388	386	380	356	348	336	330	318	306	228	213	136		
SXT 17/27	27	35		473	434	428	401	392	378	371	358	345	257	239	153		
SXT 17/29	30	40		469	466	459	430	421	406	399	384	370	276	257	165		
SXT 17/33	37	50		534	531	523	490	479	462	454	437	421	314	292	187		
SXT 17/36	37	50		582	579	570	534	522	504	495	477	460	342	319	204		
SXT 17/40	37	50		647	643	633	593	580	560	550	530	511	380	354	227		
SXT 17/48	45	60		776	772	760	712	696	672	660	636	613	456	425	273		

Dimensiones / Dimensions / Dimensions

Materiales tipo A
 Impulsor: AISI 304L
 Difusor: AISI 304L
 Eje: AISI 431
 Camisa: AISI 304

Material type A
 Impeller: AISI 304L
 Diffuser: AISI 304L
 Shaft: AISI 431
 Shell: AISI 304

Materiaux type A
 Roue: AISI 304L
 Diffuseur: AISI 304L
 Arbre: AISI 431
 Chemise: AISI 304

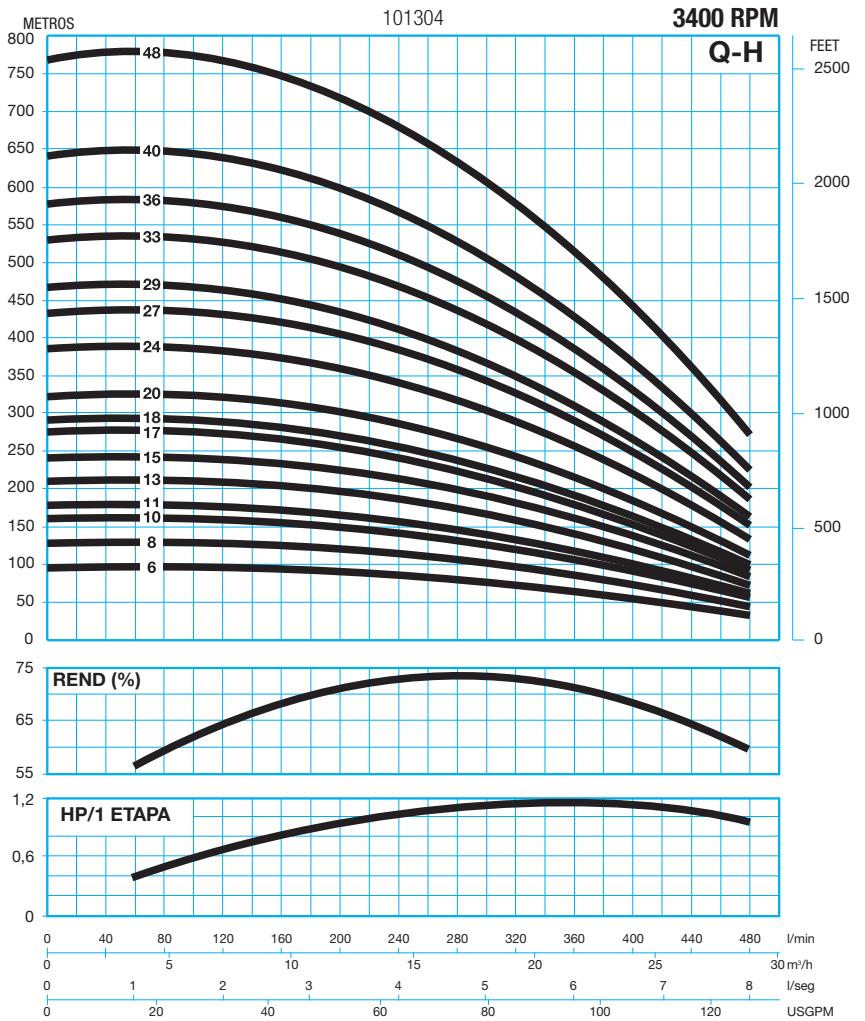
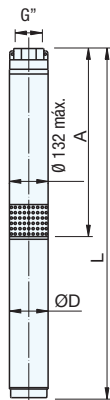

Tipo Type	Motor - Moteur		D mm	A mm	L mm	G"	Peso Weight Poids (kg)
	KW	HP					
SXT 17/6	7,5	10	144	624	1382	2 1/2"	66
SXT 17/8	9,3	12,5	144	746	1546	2 1/2"	72
SXT 17/10	11	15	144	868	1719	2 1/2"	79
SXT 17/11	11	15	144	927	1778	2 1/2"	80
SXT 17/13	13	17,5	144	1044	1895	2 1/2"	88
SXT 17/15	15	20	144	1171	2022	2 1/2"	97
SXT 17/17	19	25	144	1291	2202	2 1/2"	107
SXT 17/18	19	25	144	1349	2322	2 1/2"	109
SXT 17/20	22	30	144	1473	2479	2 1/2"	117
SXT 17/24	27	35	144	1715	2721	2 1/2"	127
SXT 17/27	27	35	144	1897	3003	2 1/2"	131
SXT 17/29	30	40	144	2015	3232	2 1/2"	147
SXT 17/33	37	50	144	2262	3479	2 1/2"	160
SXT 17/36	37	50	144	2441	3688	2 1/2"	164
SXT 17/40	37	50	144	2683	4030	2 1/2"	169
SXT 17/48	45	60	172	3160	4507	2 1/2"	211

BOMBA TIPO: RADIAL
 TEMP. MAX. LIQUIDO: 30°
 MAX. ARENA: 50 gr/m³
 SENTIDO ROT.: ANTIHORARIO
 VALV. RET.: INCORPORADA

PUMP TYPE: RADIAL
 MAXI. TEMP. LIQUID: 30°
 SAND MAX.: 50 gr/m³
 ROTATION: C.C.W.
 CHECK VAL.: BUILT-IN

POMPE TYPE: RADIALE
 TEMP. MAX. LIQUIDE: 30°
 MAX. SABLE: 50 gr/m³
 SENS. ROT.: ANTIHORAIRE
 CLAPET RET.: INCORPORÉ

Tablas de selección / Selection charts / Tables de selection

Tipo Type	Motor - Moteur		l/min. m ³ /h	Caudal - Capacity - Debit											
	KW	HP		0	240	300	360	420	480	540	600	660	720	780	840
SXT 30/4	5,5	7,5	m.c.a.	65	60	59	57	54	51	47	43	38	33	26	20
SXT 30/6	9,3	12,5		98	91	88	85	81	76	71	64	57	49	40	29
SXT 30/8	13	17,5		130	121	117	113	108	101	94	86	76	65	53	39
SXT 30/11	19	25		179	166	161	155	148	140	130	118	105	90	73	54
SXT 30/13	19	25		212	197	191	184	175	165	153	140	124	106	86	63
SXT 30/15	22	30		244	227	220	212	202	190	177	161	143	122	99	73
SXT 30/17	27	35		277	257	249	240	229	216	200	182	162	139	112	83
SXT 30/19	27	35		309	287	279	269	256	241	224	204	181	155	126	93
SXT 30/21	30	40		342	318	308	297	283	266	247	225	200	171	139	102
SXT 30/23	37	50		374	348	337	325	310	292	271	247	219	188	152	112
SXT 30/26	37	50		423	393	381	368	350	330	306	279	248	212	172	127
SXT 30/28	45	60		456	423	411	396	377	355	330	301	267	229	185	137
SXT 30/30	45	60		488	454	440	424	404	381	353	322	286	245	198	146

Dimensiones / Dimensions / Dimensions

Materiales tipo A
 Impulsor: AISI 304L
 Difusor: AISI 304L
 Eje: AISI 431
 Camisa: AISI 304

Material type A
 Impeller: AISI 304L
 Diffuser: AISI 304L
 Shaft: AISI 431
 Shell: AISI 304

Materiaux type A
 Roue: AISI 304L
 Diffuseur: AISI 304L
 Arbre: AISI 431
 Chemise: AISI 304

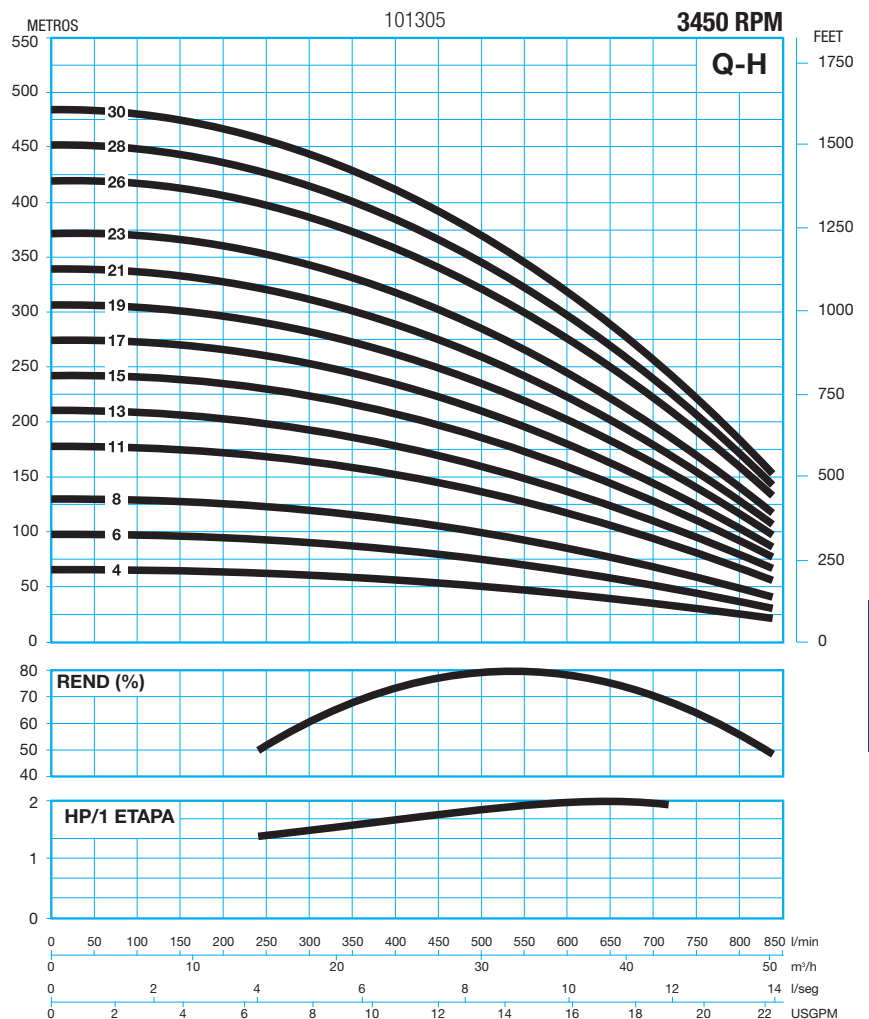
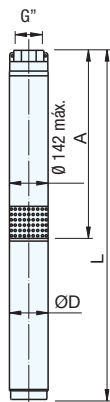

Tipo Type	Motor - Moteur		D mm	A mm	L mm	G"	Peso Weight Poids (kg)
	KW	HP					
SXT 30/4	5,5	7,5	144	590	1268	3"	58
SXT 30/6	9,3	12,5	144	945	1745	3"	72
SXT 30/8	13	17,5	144	1171	2082	3"	85
SXT 30/11	19	25	144	1510	2516	3"	104
SXT 30/13	19	25	144	1736	2742	3"	107
SXT 30/15	22	30	144	1962	3068	3"	116
SXT 30/17	27	35	144	2188	3405	3"	124
SXT 30/19	27	35	144	2414	3631	3"	127
SXT 30/21	30	40	144	2640	3887	3"	145
SXT 30/23	37	50	144	2866	4213	3"	156
SXT 30/26	37	50	144	3205	4552	3"	159
SXT 30/28	45	60	172	3431	4570	3"	195
SXT 30/30	45	60	172	3657	4796	3"	198

BOMBA TIPO: RADIAL
 TEMP. MAX. LIQUIDO: 30°
 MAX. ARENA: 50 gr/m³
 SENTIDO ROT.: ANTIHORARIO
 VALV. RET.: INCORPORADA

PUMP TYPE: RADIAL
 MAXI. TEMP. LIQUID: 30°
 SAND MAX.: 50 gr/m³
 ROTATION: C.C.W.
 CHECK VAL.: BUILT-IN

POMPE TYPE: RADIALE
 TEMP. MAX. LIQUIDE: 30°
 MAX. SABLE: 50 gr/m³
 SENS. ROT.: ANTIHORAIRE
 CLAPET RET.: INCORPORÉ

Tablas de selección / Selection charts / Tables de selection

Tipo Type	Motor - Moteur		l/min. m ³ /h	Caudal - Capacity - Debit									
	KW	HP		0	500	583,3	666,7	750	833,3	916,7	1000	1083	1167
				0	30	35	40	45	50	55	60	65	70
SXT 45/1	4	5,5	m.c.a.	20	17	16	15	14	13	12	11	10	8
SXT 45/2	5,5	7,5		40	34	32	31	29	27	25	23	20	17
SXT 45/3	7,5	10		60	51	49	46	43	40	37	34	30	25
SXT 45/4	9,3	12,5		81	68	65	61	57	54	50	45	40	33
SXT 45/5	13	17,5		101	85	81	76	72	67	62	57	50	42
SXT 45/6	15	20		121	102	97	92	86	81	75	68	60	50
SXT 45/7	18,5	25		141	120	113	107	100	94	87	79	70	58
SXT 45/8	18,5	25		161	137	129	122	115	107	100	91	80	67
SXT 45/9	22	30		181	154	146	137	129	121	112	102	90	75
SXT 45/10	26,5	35		201	171	162	153	143	134	124	114	100	83
SXT 45/11	26,5	35		222	188	178	168	158	148	137	125	110	91
SXT 45/12	30	40		242	205	194	183	172	161	149	136	120	100
SXT 45/13	30	40		262	222	210	198	186	174	162	148	130	108
SXT 45/14	37	50		282	239	226	214	201	188	174	159	140	116
SXT 45/15	37	50		302	256	243	229	215	201	187	170	150	125
SXT 45/16	37	50		322	273	259	244	230	215	199	182	160	133
SXT 45/17	45	60		342	290	275	259	244	228	212	193	170	141
SXT 45/18	45	60		363	307	291	275	258	242	224	204	181	150
SXT 45/19	45	60		383	324	307	290	273	255	237	216	191	158
SXT 45/20	52	70		403	341	323	305	287	268	249	227	201	166
SXT 45/21	55	75		423	359	340	320	301	282	261	238	211	175
SXT 45/22	55	75		443	376	356	336	316	295	274	250	221	183
SXT 45/23	55	75		463	393	372	351	330	309	286	261	231	191
SXT 45/24	55	75		483	410	388	366	344	322	299	272	241	200

Dimensiones / Dimensions / Dimensions

Materiales tipo A
 Impulsor: AISI 304L
 Difusor: AISI 304L
 Eje: AISI 431
 Camisa: AISI 304

Material type A
 Impeller: AISI 304L
 Diffuser: AISI 304L
 Shaft: AISI 431
 Shell: AISI 304

Materiaux type A
 Roue: AISI 304L
 Diffuseur: AISI 304L
 Arbre: AISI 431
 Chemise: AISI 304

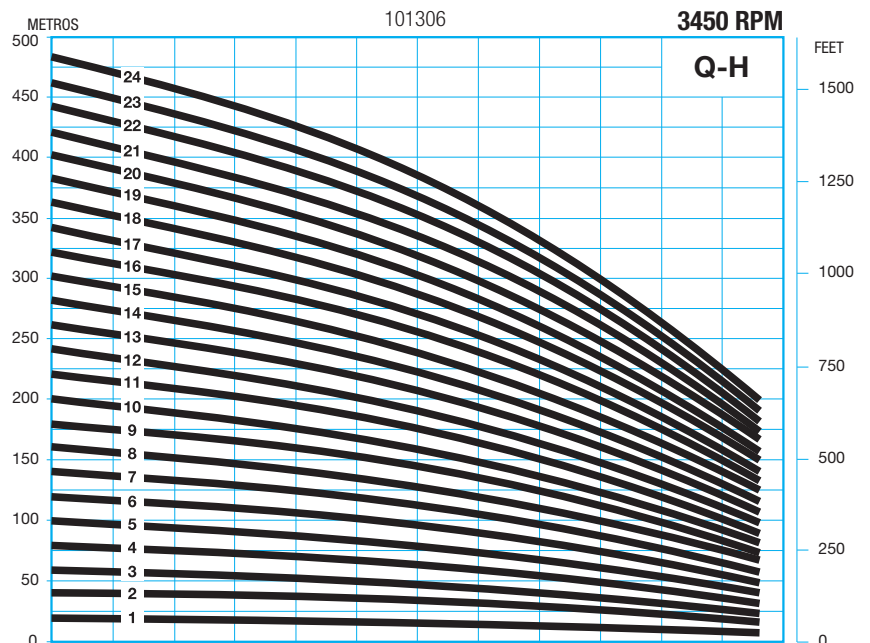
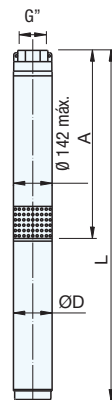

Tipo Type	Motor Moteur		D mm	A mm	L mm	G" mm	Peso Weight Poids (kg)
	KW	HP					
SXT 45/1	4	5,5	144	382	1031	4"	47
SXT 45/2	5,5	7,5	144	494	1172	4"	53,5
SXT 45/3	7,5	10	144	606	1364	4"	62
SXT 45/4	9,3	12,5	144	718	1518	4"	70
SXT 45/5	13	17,5	144	830	1741	4"	83
SXT 45/6	15	20	144	942	1915	4"	92
SXT 45/7	18,5	25	144	1054	2060	4"	99
SXT 45/8	18,5	25	144	1166	2172	4"	102
SXT 45/9	22	30	144	1278	2384	4"	115
SXT 45/10	26,5	35	144	1390	2607	4"	129
SXT 45/11	26,5	35	144	1502	2719	4"	132
SXT 45/12	30	40	144	1614	2861	4"	139
SXT 45/13	30	40	144	1726	2973	4"	142
SXT 45/14	37	50	144	1838	3185	4"	152
SXT 45/15	37	50	144	1950	3297	4"	154
SXT 45/16	37	50	144	2062	3409	4"	157
SXT 45/17	45	60	172	2174	3313	4"	176
SXT 45/18	45	60	172	2286	3425	4"	179
SXT 45/19	45	60	172	2398	3537	4"	182
SXT 45/20	52	70	172	2510	3728	4"	195
SXT 45/21	55	75	172	2622	3842	4"	199
SXT 45/22	55	75	172	2734	3984	4"	201
SXT 45/23	55	75	172	2846	4096	4"	203
SXT 45/24	55	75	172	2958	4208	4"	206

BOMBA TIPO: RADIAL
 TEMP. MAX. LIQUIDO: 30°
 MAX. ARENA: 50 gr/m³
 SENTIDO ROT.: ANTIHORARIO
 VALV. RET.: INCORPORADA

PUMP TYPE: RADIAL
 MAXI. TEMP. LIQUID: 30°
 SAND MAX.: 50 gr/m³
 ROTATION: C.C.W.
 CHECK VAL.: BUILT-IN

POMPE TYPE: RADIALE
 TEMP. MAX. LIQUIDE: 30°
 MAX. SABLE: 50 gr/m³
 SENS. ROT.: ANTIHORAIRE
 CLAPET RET.: INCORPORÉ

Tablas de selección / Selection charts / Tables de selection

Tipo Type	Motor - Moteur		l/min. m ³ /h	Caudal - Capacity - Debit											
	KW	HP		0	300	360	480	540	660	780	900	1020	1080	1200	1440
				0	18	21,6	28,8	32,4	39,6	46,8	54	61,2	64,8	72	86,4
SXT 60/2	7,5	10	m.c.a.	39	37	36	34	33	31	29	27	25	24	22	13
SXT 60/3	9,3	12,5		59	56	55	51	50	47	44	41	38	36	33	20
SXT 60/4	13	17,5		79	75	73	69	67	62	58	55	51	49	43	26
SXT 60/5	15	20		98	93	91	86	83	78	73	68	64	61	54	33
SXT 60/6	19	25		118	112	109	103	100	94	88	82	76	73	65	39
SXT 60/7	22	30		138	131	127	120	116	109	102	96	89	85	76	46
SXT 60/8	27	35		157	149	145	137	133	125	117	109	102	97	87	52
SXT 60/9	27	35		177	168	164	154	150	140	132	123	114	109	98	59
SXT 60/10	30	40		196	187	182	172	166	156	146	137	127	122	108	65
SXT 60/11	37	50		216	205	200	189	183	172	161	151	140	134	119	72
SXT 60/12	37	50		236	224	218	206	200	187	175	164	152	146	130	78
SXT 60/13	45	60		255	243	236	223	216	203	190	178	165	158	141	85
SXT 60/15	45	60		295	280	273	257	250	234	219	205	191	182	163	98

Dimensiones / Dimensions / Dimensions

Materiales tipo A
 Impulsor: AISI 304L
 Difusor: AISI 304L
 Eje: AISI 431
 Camisa: AISI 304

Material type A
 Impeller: AISI 304L
 Diffuser: AISI 304L
 Shaft: AISI 431
 Shell: AISI 304

Materiaux type A
 Roue: AISI 304L
 Diffuseur: AISI 304L
 Arbre: AISI 431
 Chemise: AISI 304

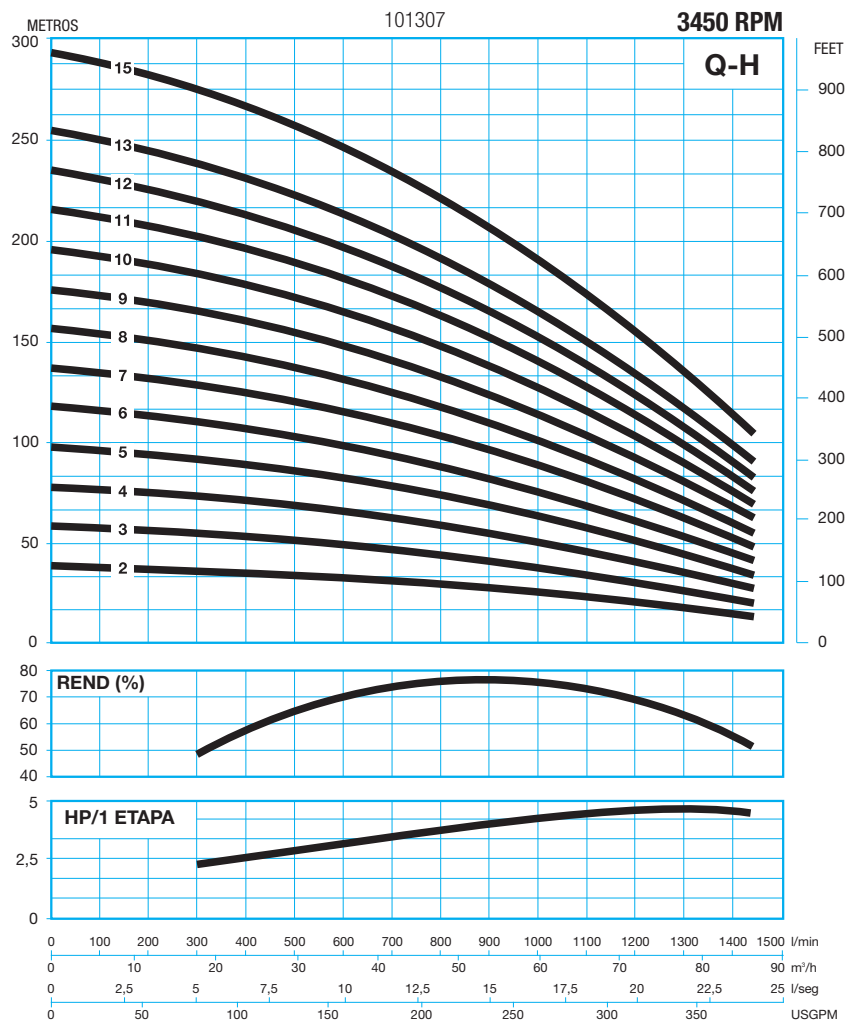
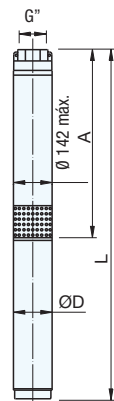

Tipo Type	Motor - Moteur		D mm	A mm	L mm	G"	Peso Weight Poids (kg)
	KW	HP					
SXT 60/2	7,5	10	144	477	1235	4"	63
SXT 60/3	9,3	12,5	144	606	1406	4"	69
SXT 60/4	13	17,5	144	719	1630	4"	80
SXT 60/5	15	20	144	832	1805	4"	88
SXT 60/6	19	25	144	945	1951	4"	98
SXT 60/7	22	30	144	1058	2164	4"	106
SXT 60/8	27	35	144	1171	2388	4"	113
SXT 60/9	27	35	144	1284	2501	4"	115
SXT 60/10	30	40	144	1397	2644	4"	131
SXT 60/11	37	50	144	1510	2857	4"	141
SXT 60/12	37	50	144	1623	2970	4"	143
SXT 60/13	45	60	172	1736	2875	4"	177
SXT 60/15	45	60	172	1961	3100	4"	182

BOMBA TIPO: RADIAL
 TEMP. MAX. LIQUIDO: 30°
 MAX. ARENA: 50 gr/m³
 SENTIDO ROT.: ANTIHORARIO
 VALV. RET.: INCORPORADA

PUMP TYPE: RADIAL
 MAXI. TEMP. LIQUID: 30°
 SAND MAX.: 50 gr/m³
 ROTATION: C.C.W.
 CHECK VAL.: BUILT-IN

POMPE TYPE: RADIALE
 TEMP. MAX. LIQUIDE: 30°
 MAX. SABLE: 50 gr/m³
 SENS. ROT.: ANTIHORAIRE
 CLAPET RET.: INCORPORÉ

Tablas de selección / Selection charts / Tables de selection

Tipo Type	Motor - Moteur		l/min. m ³ /h	Caudal - Capacity - Debit											
	KW	HP		0	240	480	720	960	1200	1320	1440	1560	1680	1920	2160
				0	14	28,8	43,2	57,6	72	79,2	86,4	93,6	100,8	115,2	129,6
SXT 75/1	7,5	10	m.c.a.	28	28	27	26	24	22	21	20	19	17	14	9
SXT 75/2	13	17,5		56	56	54	51	48	45	43	40	38	35	28	18
SXT 75/3	22	30		85	83	81	77	73	67	64	60	56	52	41	28
SXT 75/4	27	35		113	111	108	103	97	89	85	80	75	69	55	37
SXT 75/5	37	50		141	139	135	129	121	112	106	100	94	86	69	46
SXT 75/6	45	60		169	167	162	154	145	134	128	120	113	104	83	55
SXT 75/7	45	60		198	195	189	180	169	156	149	140	131	121	96	65
SXT 75/8	52	70		226	223	216	206	193	179	170	160	150	138	110	74
SXT 75/10	67	90		282	278	270	257	242	223	213	201	188	173	138	92
SXT 75/12	75	100		339	334	323	309	290	268	255	241	225	207	165	111
SXT 75/14	92	125		395	390	377	360	339	313	298	281	263	242	193	129
SXT 75/15	110	150		423	417	404	386	363	335	319	301	281	259	206	138
SXT 75/16	110	150		452	445	431	411	387	357	340	321	300	276	220	148

Dimensiones / Dimensions / Dimensions

Materiales tipo A
 Impulsor: AISI 304L
 Difusor: AISI 304L
 Eje: AISI 431
 Camisa: AISI 304

Material type A
 Impeller: AISI 304L
 Diffuser: AISI 304L
 Shaft: AISI 431
 Shell: AISI 304

Materiaux type A
 Roue: AISI 304L
 Diffuseur: AISI 304L
 Arbre: AISI 431
 Chemise: AISI 304

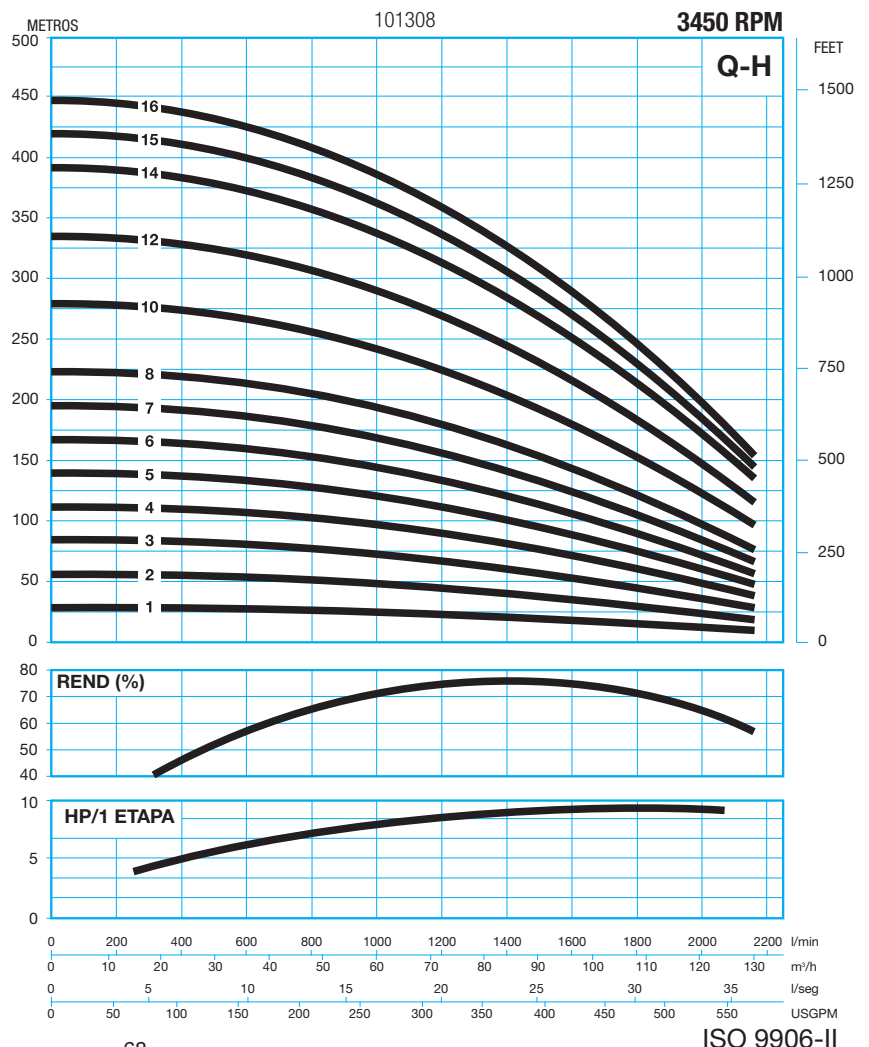
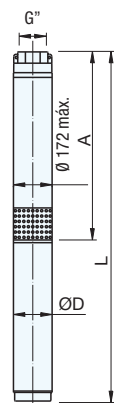

Tipo Type	Motor - Moteur		D mm	A mm	L mm	G"	Peso Weight Poids (kg)
	KW	HP					
SXT 75/1	7,5	10	144	479	1237	5"	77
SXT 75/2	13	17,5	144	607	1518	5"	95
SXT 75/3	22	30	144	735	1841	5"	119
SXT 75/4	27	35	144	863	2080	5"	126
SXT 75/5	37	50	144	991	2338	5"	150
SXT 75/6	45	60	190	1119	2320	5"	183
SXT 75/7	45	60	190	1247	2448	5"	187
SXT 75/8	52	70	190	1375	2661	5"	199
SXT 75/10	67	90	190	1631	2997	5"	230
SXT 75/12	75	100	190	1903	3294	5"	257
SXT 75/14	92	125	190	2159	3695	5"	282
SXT 75/15	110	150	231	2287	3797	5"	377
SXT 75/16	110	150	231	2415	3925	5"	382

BOMBA TIPO: RADIAL
 TEMP. MAX. LIQUIDO: 30°
 MAX. ARENA: 50 gr/m³
 SENTIDO ROT.: ANTIHORARIO
 VALV. RET.: INCORPORADA

PUMP TYPE: RADIAL
 MAXI. TEMP. LIQUID: 30°
 SAND MAX.: 50 gr/m³
 ROTATION: C.C.W.
 CHECK VAL.: BUILT-IN

POMPE TYPE: RADIALE
 TEMP. MAX. LIQUIDE: 30°
 MAX. SABLE: 50 gr/m³
 SENS. ROT.: ANTIHORAIRE
 CLAPET RET.: INCORPORÉ

Tablas de selección / Selection charts / Tables de selection

Tipo Type	Motor - Moteur		l/min. m ³ /h	Caudal - Capacity - Debit									
	KW	HP		0	666,7	1167	1333	1500	1667	1833	2000	2167	2333
SXT 95/1	9,3	12,5	m.c.a.	31	30	27	26	25	24	22	21	18	15
SXT 95/2	18,5	25		61	60	54	53	50	48	45	41	36	29
SXT 95/3	26,5	35		92	90	82	79	76	72	67	62	54	44
SXT 95/4	37	50		123	119	109	105	101	96	90	82	72	59
SXT 95/5	45	60		153	149	136	131	126	120	112	103	90	73
SXT 95/6	52	70		184	179	163	158	151	144	135	123	108	88
SXT 95/7	60	80		215	209	191	184	176	168	157	144	126	103
SXT 95/8	67	90		245	239	218	210	202	192	179	164	144	117
SXT 95/9	75	100		276	269	245	236	227	216	202	185	162	132
SXT 95/10	81	110		307	298	272	263	252	240	224	205	180	147
SXT 95/11	92	125		337	328	300	289	277	263	247	226	198	161

Dimensiones / Dimensions / Dimensions

Materiales tipo A
 Impulsor: AISI 304L
 Difusor: AISI 304L
 Eje: AISI 431
 Camisa: AISI 304

Material type A
 Impeller: AISI 304L
 Diffuser: AISI 304L
 Shaft: AISI 431
 Shell: AISI 304

Materiaux type A
 Roue: AISI 304L
 Diffuseur: AISI 304L
 Arbre: AISI 431
 Chemise: AISI 304

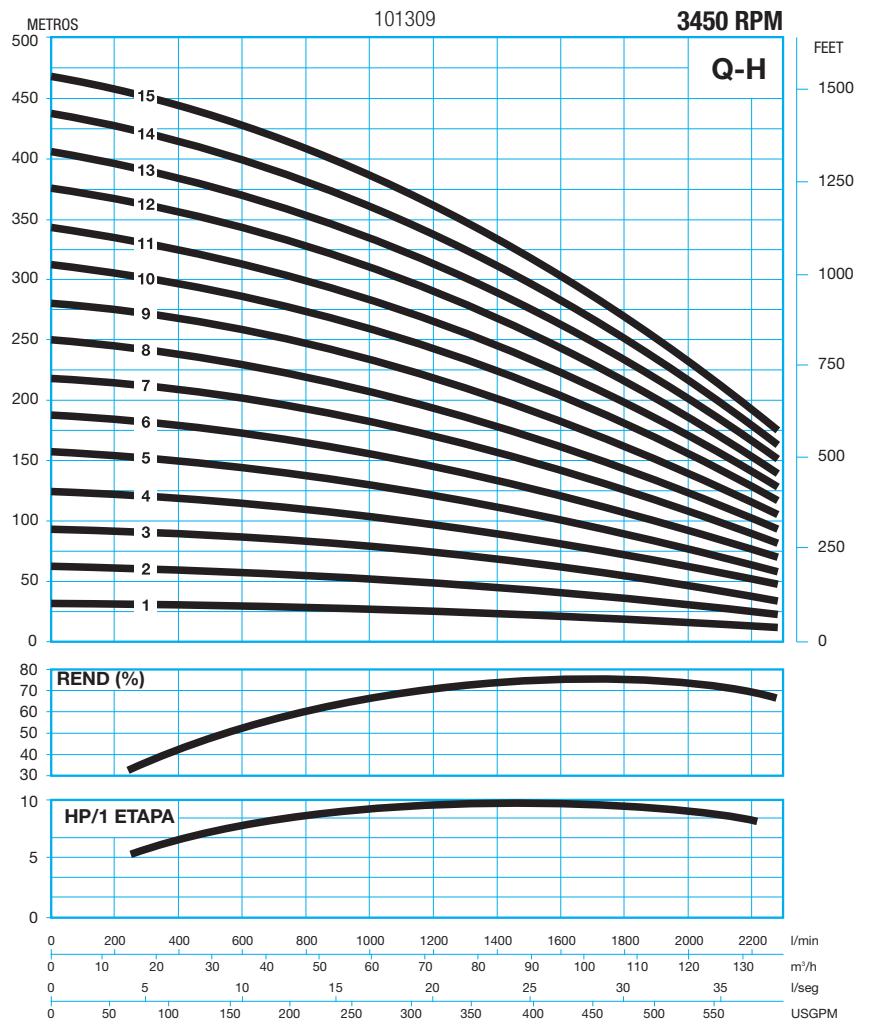
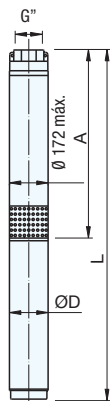

Tipo Type	Motor - Moteur		D mm	A mm	L mm	G"	Peso Weight Poids (kg)
	KW	HP					
SXT 95/1	9,3	12,5	142	571	1371	5"	81
SXT 95/2	18,5	25	142	699	1705	5"	106
SXT 95/3	26,5	35	142	827	2044	5"	132
SXT 95/4	37	50	142	955	2202	5"	148
SXT 95/5	45	60	172	1083	2222	5"	169
SXT 95/6	52	70	172	1211	2429	5"	184
SXT 95/7	60	80	192	1339	2680	5"	235
SXT 95/8	67	90	192	1467	2833	5"	240
SXT 95/9	75	100	192	1595	2986	5"	253
SXT 95/10	81	110	192	1723	3194	5"	272
SXT 95/11	92	125	192	1851	3387	5"	278

BOMBA TIPO: RADIAL
 TEMP. MAX. LIQUIDO: 30°
 MAX. ARENA: 50 gr/m³
 SENTIDO ROT.: ANTIHORARIO
 VALV. RET.: INCORPORADA

PUMP TYPE: RADIAL
 MAXI. TEMP. LIQUID: 30°
 SAND MAX.: 50 gr/m³
 ROTATION: C.C.W.
 CHECK VAL.: BUILT-IN

POMPE TYPE: RADIALE
 TEMP. MAX. LIQUIDE: 30°
 MAX. SABLE: 50 gr/m³
 SENS. ROT.: ANTIHORAIRE
 CLAPET RET.: INCORPORÉ

Tablas de selección / Selection charts / Tables de selection

Tipo Type	Motor - Moteur		l/min. m ³ /h	Caudal - Capacity - Debit									
	KW	HP		0	666,7	1000	1332	1668	1998	2334	2664	3000	3336
SXT 125/1	18,5	25	m.c.a.	47	45	43	41	39	37	35	32	28	22
SXT 125/2 B1	30	40		83	79	76	73	69	66	61	56	49	39
SXT 125/3 B1	45	60		130	123	119	114	108	103	96	88	76	61
SXT 125/3	52	70		141	134	129	124	118	112	104	95	83	66
SXT 125/4	67	90		188	179	172	165	157	149	139	127	111	88
SXT 125/5 B1	75	100		224	213	205	196	187	177	166	151	132	105
SXT 125/5	92	125		235	223	215	206	196	186	174	159	138	111
SXT 125/6	92	125		282	268	258	247	236	223	209	190	166	133
SXT 125/7	110	150		329	313	301	288	275	260	243	222	194	155
SXT 125/8	132	175		376	357	344	329	314	298	278	254	221	177
SXT 125/9 B2	132	175		400	381	366	351	334	317	296	270	236	188
SXT 125/9	147	200		423	402	387	371	353	335	313	286	249	199
SXT 125/10 B2	147	200	447	425	409	392	374	354	331	302	263	210	
SXT 125/10	166	225	470	447	430	412	393	372	348	317	277	221	
SXT 125/11	166	225	517	491	473	453	432	409	383	349	304	243	

Dimensiones / Dimensions / Dimensions

Materiales tipo A
 Impulsor: AISI 304L
 Difusor: AISI 304L
 Eje: AISI 420
 Camisa: AISI 304

Material type A
 Impeller: AISI 304L
 Diffuser: AISI 304L
 Shaft: AISI 420
 Shell: AISI 304

Materiaux type A
 Roue: AISI 304L
 Diffuseur: AISI 304L
 Arbre: AISI 420
 Chemise: AISI 304

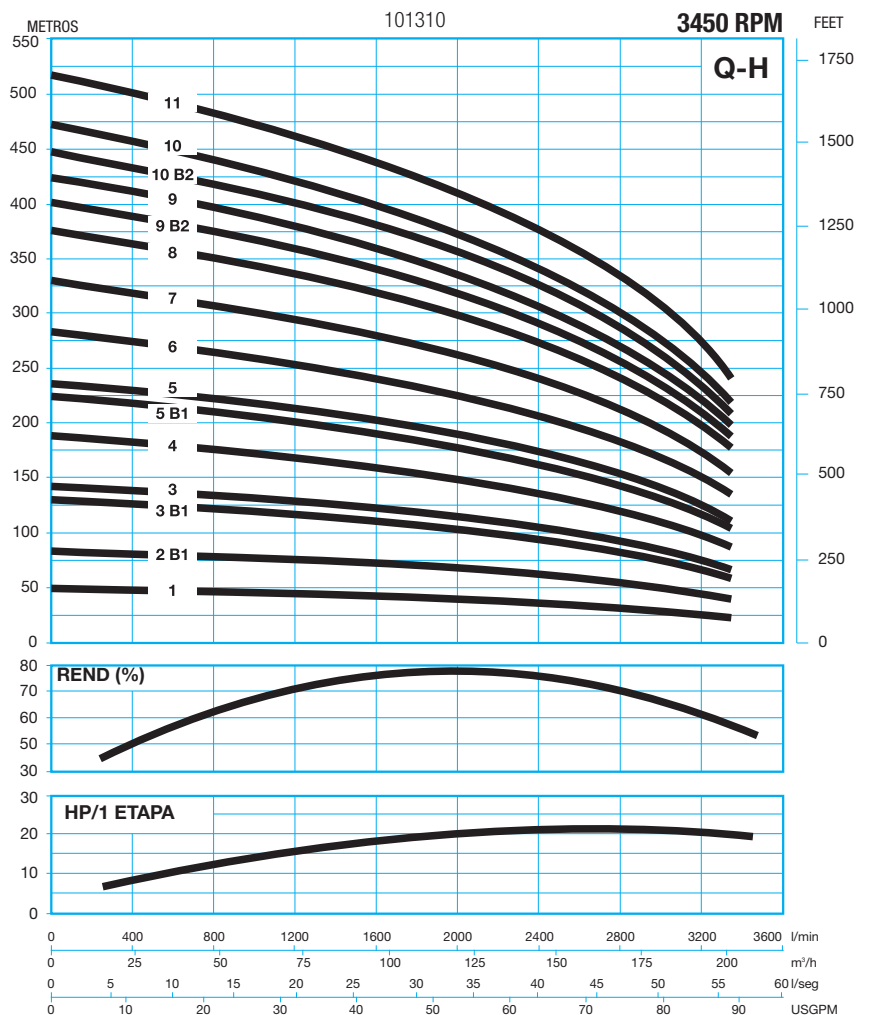
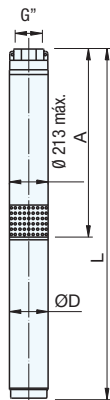

Tipo Type	Motor Moteur		D mm	A mm	L mm	G" mm	Peso Weight Poids (kg)
	KW	HP					
SXT 125/1	18,5	25	142	686	1692	6"	108
SXT 125/2 B1	30	40	142	842	2089	6"	142
SXT 125/3 B1	45	60	172	997	2136	6"	172
SXT 125/3	52	70	172	997	2215	6"	183
SXT 125/4	67	90	192	1153	2519	6"	238
SXT 125/5 B1	75	100	192	1309	2700	6"	253
SXT 125/5	92	125	192	1309	2845	6"	270
SXT 125/6	92	125	192	1465	3001	6"	277
SXT 125/7	110	150	231	1620	3130	6"	382
SXT 125/8	132	175	231	1776	3386	6"	416
SXT 125/9 B2	132	175	231	1932	3542	6"	422
SXT 125/9	147	200	231	1932	3672	6"	454
SXT 125/10 B2	147	200	231	2087	3827	6"	461
SXT 125/10	166	225	231	2087	3907	6"	491
SXT 125/11	166	225	231	2243	4063	6"	497

BOMBA TIPO: RADIAL
 TEMP. MAX. LIQUIDO: 30°
 MAX. ARENA: 50 gr/m³
 SENTIDO ROT.: ANTIHORARIO
 VALV. RET.: INCORPORADA

PUMP TYPE: RADIAL
 MAXI. TEMP. LIQUID: 30°
 SAND MAX.: 50 gr/m³
 ROTATION: C.C.W.
 CHECK VAL.: BUILT-IN

POMPE TYPE: RADIALE
 TEMP. MAX. LIQUIDE: 30°
 MAX. SABLE: 50 gr/m³
 SENS. ROT.: ANTIHORAIRE
 CLAPET RET.: INCORPORÉ

Tablas de selección / Selection charts / Tables de selection

Tipo Type	Motor - Moteur		l/min. m ³ /h	Caudal - Capacity - Debit											
	KW	HP		0	600	1500	1800	2100	2400	2700	3000	3300	3600	3900	4200
SXT 160/1	22	30	m.c.a.	35	34	31	29	28	27	25	24	22	20	16	13
SXT 160/2B	30	40		67	63	57	55	52	49	46	43	40	36	30	24
SXT 160/2	45	60		70	68	61	59	56	53	50	47	43	39	32	26
SXT 160/3B	52	70		100	95	86	82	78	74	69	65	60	54	45	36
SXT 160/3	60	80		105	102	92	88	84	80	75	71	65	59	48	39
SXT 160/4	75	100		140	136	122	118	112	107	100	95	87	78	64	52
SXT 160/5	92	125		175	170	153	147	140	133	125	118	109	98	80	65
SXT 160/6B	110	150		200	189	171	164	156	147	138	129	120	108	90	72
SXT 160/6	110	150		210	204	183	177	168	160	150	142	130	117	96	78
SXT 160/7B	129	175		233	221	200	191	182	172	161	151	140	126	105	84
SXT 160/7	129	175		245	238	214	206	196	187	175	166	152	137	112	91
SXT 160/8	147	200	280	272	244	235	225	214	200	189	174	156	128	104	
SXT 160/9	166	225	315	306	275	265	253	240	225	213	195	176	144	117	
SXT 160/10	185	250	350	340	305	294	281	267	250	237	217	195	160	130	

Dimensiones / Dimensions / Dimensions

Materiales tipo A
 Impulsor: AISI 304L
 Difusor: AISI 304L
 Eje: AISI 431
 Camisa: AISI 304

Material type A
 Impeller: AISI 304L
 Diffuser: AISI 304L
 Shaft: AISI 431
 Shell: AISI 304

Materiaux type A
 Roue: AISI 304L
 Diffuseur: AISI 304L
 Arbre: AISI 431
 Chemise: AISI 304

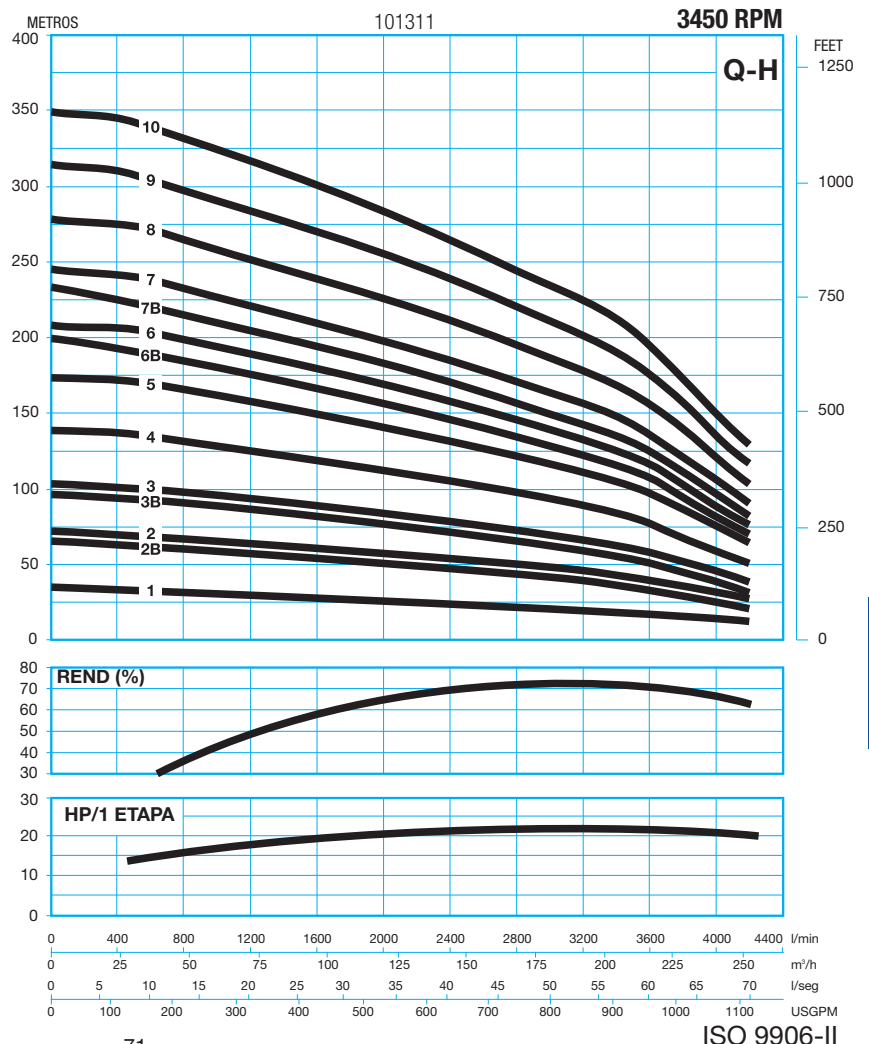
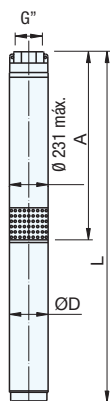

Tipo Type	Motor - Moteur		D mm	A mm	L mm	G"	Peso Weight Poids (kg)
	KW	HP					
SXT 160/1	22	30	144	700	1806	6"	124
SXT 160/2B	30	40	144	850	2097	6"	148
SXT 160/2	45	60	190	850	2051	6"	180
SXT 160/3B	52	70	190	1000	2286	6"	196
SXT 160/3	60	80	190	1000	2341	6"	210
SXT 160/4	75	100	190	1150	2541	6"	246
SXT 160/5	92	125	190	1300	2836	6"	270
SXT 160/6B	110	150	231	1450	2960	6"	367
SXT 160/6	110	150	231	1450	2960	6"	367
SXT 160/7B	129	175	231	1600	3210	6"	402
SXT 160/7	129	175	231	1600	3210	6"	402
SXT 160/8	147	200	231	1750	3490	6"	448
SXT 160/9	166	225	231	1900	3720	6"	488
SXT 160/10	185	250	231	2050	3870	6"	528

BOMBA TIPO: SEMIAXIAL
 TEMP. MAX. LIQUIDO: 25°
 MAX. ARENA: 40 gr/m³
 SENTIDO ROT.: ANTIHORARIO
 VALV. RET.: INCORPORADA

PUMP TYPE: MIXED FLOW
 MAXI. TEMP. LIQUID: 25°
 SAND MAX.: 40 gr/m³
 ROTATION: C.C.W.
 CHECK VAL.: BUILT IN

POMPE TYPE: SEMIAXIAL
 TEMP. MAX. LIQUIDE: 25°
 MAX. SABLE: 40 gr/m³
 SENS. ROT.: ANTIHORAIRE
 CLAPET RET.: INCORPORÉ

Tablas de selección / Selection charts / Tables de selection

Tipo Type	Motor - Moteur		l/min. m ³ /h	Caudal - Capacity - Debit					
	KW	HP		0	240	360	480	600	660
SD 0,30-2F2	3	4	m.c.a.	35	32	29	24	19	15
SD 0,30-2	4	5,5		38	35	31	27	21	17
SD 0,30-3	5,5	7,5		57	52	47	40	31	25
SD 0,30-5F5	7,4	10		87	79	71	61	47	38
SD 0,30-6F5	9	12,5		106	97	87	74	58	46
SD 0,30-7F3	11	15		128	118	105	90	70	56
SD 0,30-9F1	15	20		170	156	139	119	92	74
SD 0,30-11	18	25		210	192	172	147	114	92
SD 0,30-13	22	30		248	227	203	173	135	109
SD 0,30-16F4	25,76	35		298	273	245	208	162	131

Dimensiones / Dimensions / Dimensions

Materiales tipo A
 Impulsor: Hierro fundido
 Cuerpo: Hierro fundido
 Eje: Acero inox.

Material type A
 Impeller: Cast iron
 Bowl: AISI 304L
 Shaft: St. steel

Materiaux type A
 Roue: Fonte
 Corps: Fonte
 Arbre: Acier inox.

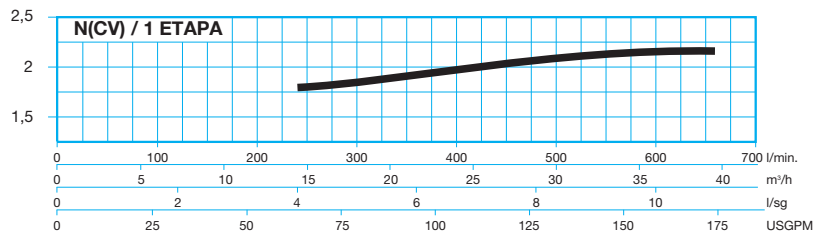
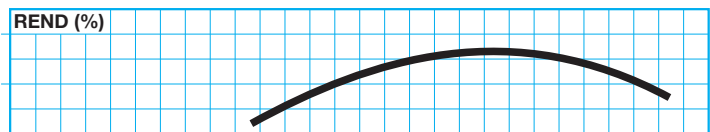
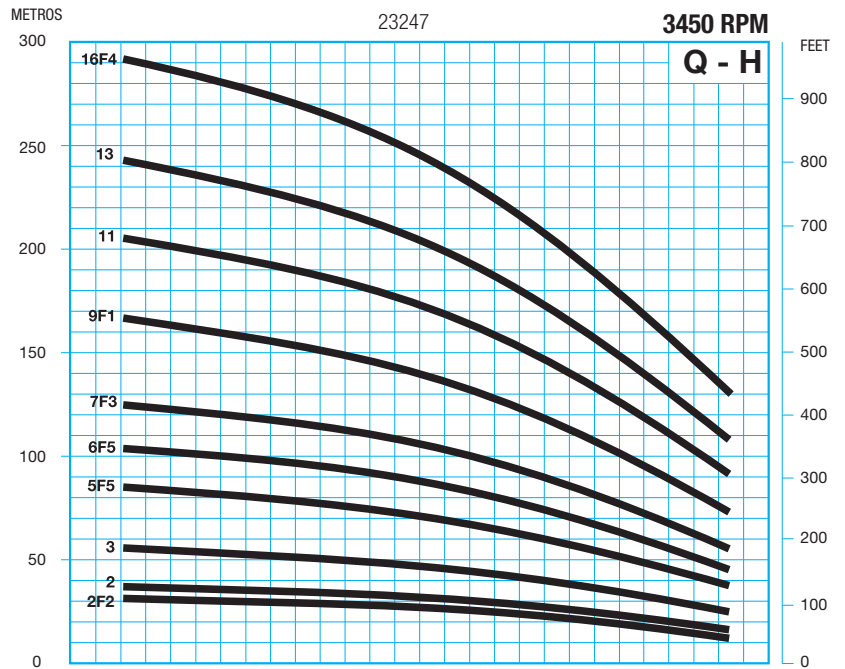
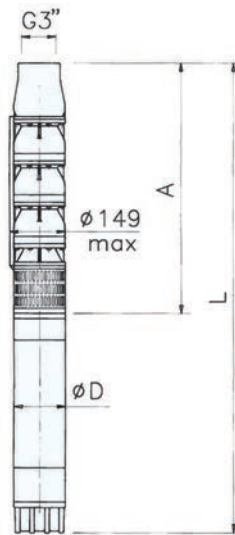

Tipo Type	Motor - Moteur		D mm	A mm	L mm	Peso Weight Poids (kg)
	KW	HP				
SD 0,30-2F2	3	4	90	548	1062	42
SD 0,30-2	4	5,5	90	548	1138	47
SD 0,30-3	5,5	7,5	140	663	1367	58
SD 0,30-5F5	7,4	10	140	920	1556	85
SD 0,30-6F5	9	12,5	140	1035	1704	93
SD 0,30-7F3	11	15	140	1150	1861	102
SD 0,30-9F1	15	20	140	1380	2081	119
SD 0,30-11	18	25	140	1610	2441	139
SD 0,30-13	22	30	140	1840	2736	157
SD 0,30-16F4	25,76	35	145	2185	3299	212

BOMBA TIPO: SEMIAXIAL
 TEMP. MAX. LIQUIDO: 25°
 MAX. ARENA: 40 gr/m³
 SENTIDO ROT.: ANTIHORARIO
 VALV. RET.: INCORPORADA

PUMP TYPE: MIXED FLOW
 MAXI. TEMP. LIQUID: 25°
 SAND MAX.: 40 gr/m³
 ROTATION: C.C.W.
 CHECK VAL.: BUILT-IN

POMPE TYPE: SEMIAXIAL
 TEMP. MAX. LIQUIDE: 25°
 MAX. SABLE: 40 gr/m³
 SENS. ROT.: ANTIHORAIRE
 CLAPET RET.: INCORPORÉ

Tablas de selección / Selection charts / Tables de selection

Tipo Type	Motor - Moteur		l/min. m ³ /h	Caudal - Capacity - Debit					
	KW	HP		0	480	600	660	720	840
SD 0,36 - 2 F2	4	5,5	m.c.a.	0	28,8	36	39,6	43,2	50,4
SD 0,36 - 2	5,5	7,5		35	31	26	24	22	16
SD 0,36 - 3	7,5	10		40	33	31	28	25	17
SD 0,36 - 3	7,5	10		60	49	46	42	38	26
SD 0,36 - 4	9,2	12,5		79	66	61	56	50	35
SD 0,36 - 5	11	15		99	82	76	70	63	43
SD 0,36 - 6F4	13	17,5		110	94	83	77	69	50
SD 0,36 - 7F5	15	20		128	110	96	89	80	58
SD 0,36 - 8	18,5	25		159	131	122	112	100	69
SD 0,36 - 10F3	22	30		192	161	146	134	121	85
SD 0,36 - 11	26	35	219	181	168	154	138	95	
SD 0,36 - 13F1	30	40	256	212	196	180	161	112	

Dimensiones / Dimensions / Dimensions

Materiales tipo A
 Impulsor: Hierro fundido
 Cuerpo: Hierro fundido
 Eje: Acero inox.

Material type A
 Impeller: Cast iron
 Bowl: AISI 304L
 Shaft: St. steel

Materiaux type A
 Roue: Fonte
 Corps: Fonte
 Arbre: Acier inox.

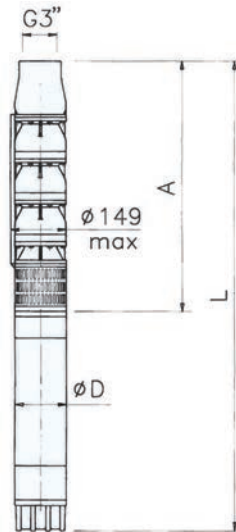

Tipo Type	Motor - Moteur		D mm	A mm	L mm	Peso Weight Poids (kg)
	KW	HP				
SD 0,36-2 F2	4	5,5	90	545	1135	51
SD 0,36-2	5,5	7,5	90	545	1249	56
SD 0,36-3	7,5	10	140	690	1326	73
SD 0,36-4	9,2	12,5	140	805	1473	83
SD 0,36-5	11	15	140	920	1621	91
SD 0,36-6F4	13	17,5	140	1035	1801	102
SD 0,36-7F5	15	20	140	1150	1916	97
SD 0,36-8	18,5	25	140	1265	2096	119
SD 0,36-10F3	22	30	140	1495	2391	135
SD 0,36-11	26	35	140	1610	2636	153
SD 0,36-13F1	30	40	140	1840	2866	163

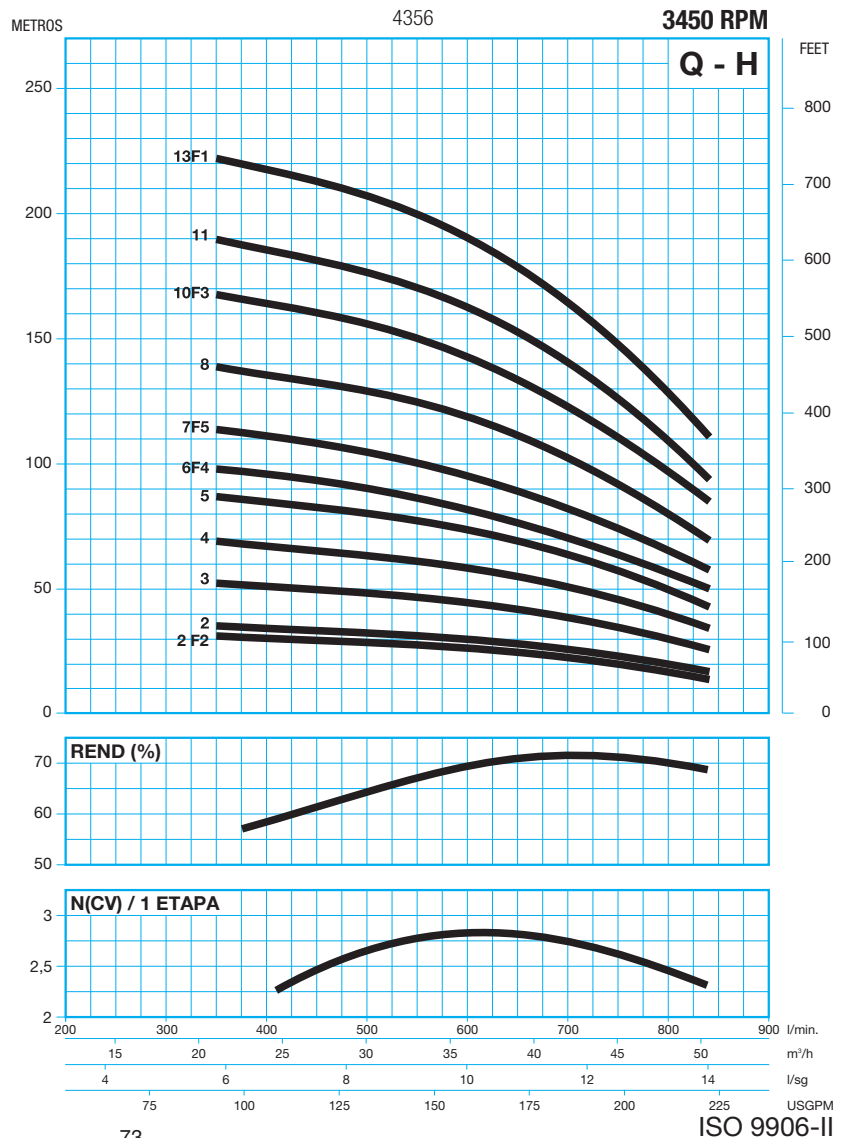

60HZ



BOMBA TIPO: SEMIAXIAL
 TEMP. MAX. LIQUIDO: 25°
 MAX. ARENA: 40 gr/m³
 SENTIDO ROT.: ANTIHORARIO
 VALV. RET.: INCORPORADA

PUMP TYPE: MIXED FLOW
 MAXI. TEMP. LIQUID: 25°
 SAND MAX.: 40 gr/m³
 ROTATION: C.C.W.
 CHECK VAL.: BUILT-IN

POMPE TYPE: SEMIAXIAL
 TEMP. MAX. LIQUIDE: 25°
 MAX. SABLE: 40 gr/m³
 SENS. ROT.: ANTIHORAIRE
 CLAPET RET.: INCORPORÉ

Tablas de selección / Selection charts / Tables de selection

Tipo Type	Motor - Moteur		l/min. m ³ /h	Caudal - Capacity - Debit					
	KW	HP		0	600	720	840	1080	1140
				0	36	43,2	50,4	64,8	68,4
SD 0,42 - 1	4	5,5	m.c.a.	23	20	18	16	12	10
SD 0,42 - 2F2	5,5	7,5		40	33	30	27	19	13
SD 0,42 - 2	7,5	10		46	39	36	33	24	20
SD 0,42 - 3F3	9,2	12,5		60	50	45	41	28	19
SD 0,42 - 3	11	15		69	59	54	49	36	29
SD 0,42 - 4F2	13	17,5		86	73	67	60	42	33
SD 0,42 - 4	15	20		92	79	73	65	49	39
SD 0,42 - 5	18,5	25		115	99	91	81	61	49
SD 0,42 - 6	22	30		138	118	109	98	73	59
SD 0,42 - 7	26	35		161	138	127	114	85	69
SD 0,42 - 8	30	40	184	158	145	130	97	78	
SD 0,42 - 10	37	50	230	197	181	163	121	98	

Dimensiones / Dimensions / Dimensions

Materiales tipo A
 Impulsor: Hierro fundido
 Cuerpo: Hierro fundido
 Eje: Acero inox.

Material type A
 Impeller: Cast iron
 Bowl: AISI 304L
 Shaft: St. steel

Materiaux type A
 Roue: Fonte
 Corps: Fonte
 Arbre: Acier inox.

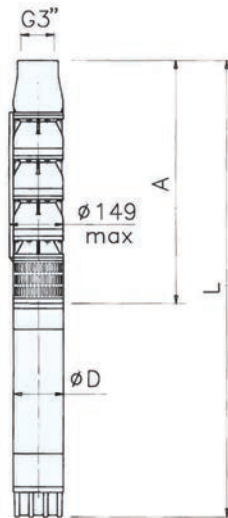

Tipo Type	Motor - Moteur		D mm	A mm	L mm	Peso Weight Poids (kg)
	KW	HP				
SD 0,42-1	4	5,5	90	430	1020	51
SD 0,42-2F2	5,5	7,5	90	545	1249	56
SD 0,42-2	7,5	10	140	575	1211	68
SD 0,42-3F3	9,2	12,5	140	690	1358	77
SD 0,42-3	11	15	140	690	1391	80
SD 0,42-4F2	13	17,5	140	805	1571	92
SD 0,42-4	15	20	140	805	1571	92
SD 0,42-5	18,5	25	140	920	1751	104
SD 0,42-6	22	30	140	1035	1931	115
SD 0,42-7	26	35	140	1150	2176	133
SD 0,42-8	30	40	140	1265	2291	138
SD 0,42-10	37	50	140	1495	2964	188

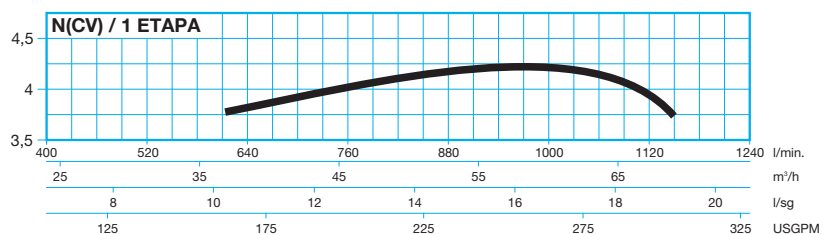
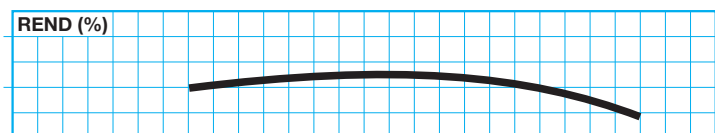
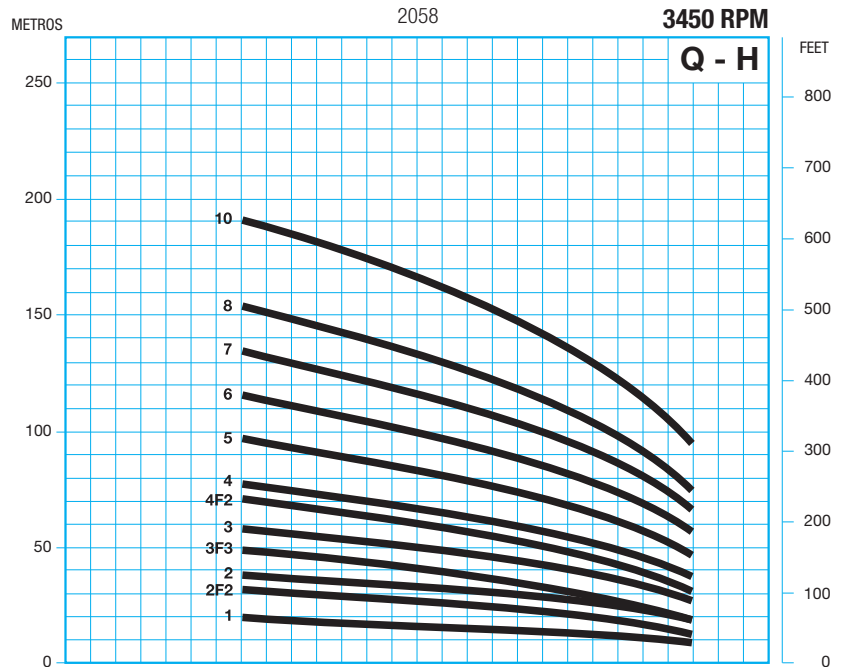

BOMBA TIPO: SEMIAXIAL
 TEMP. MAX. LIQUIDO: 25°
 MAX. ARENA: 40 gr/m³
 SENTIDO ROT.: ANTIHORARIO
 VALV. RET.: INCORPORADA

PUMP TYPE: MIXED FLOW
 MAXI. TEMP. LIQUID: 25°
 SAND MAX.: 40 gr/m³
 ROTATION: C.C.W.
 CHECK VAL.: BUILT IN

POMPE TYPE: SEMIAXIAL
 TEMP. MAX. LIQUIDE: 25°
 MAX. SABLE: 40 gr/m³
 SENS. ROT.: ANTIHORAIRE
 CLAPET RET.: INCORPORÉ

Tablas de selección / Selection charts / Tables de selection

Tipo Type	Motor - Moteur		l/min. m ³ /h	Caudal - Capacity - Debit					
	KW	HP		0	600	900	1200	1500	1700
SD 0,46-1	4	5,5	m.c.a.	20	17	16	14	10,5	5
SD 0,46-2F2E	5,5	7,5		35	28	25	20	14	5
SD 0,46-2	7,5	10		41	35	32	27	20,5	9
SD 0,46-3F3	9,2	12,5		55	42	40	34	29	8
SD 0,46-3	11	15		61	52	48	41	31	14
SD 0,46-4	15	20		82	69	63	55	41	18
SD 0,46-5	18,5	25		102	86	79	69	51	23
SD 0,46-6	22	30		123	104	95	82	61	27
SD 0,46-7	26	35		149	121	111	96	72	32
SD 0,46-8	30	40		164	138	127	109	82	36
SD 0,46-10	37	50		204	173	158	137	102	45
SD 0,46-12	45	60		245	207	190	164	123	54

Dimensiones / Dimensions / Dimensions

Materiales tipo A
 Impulsor: Hierro fundido
 Cuerpo: Hierro fundido
 Eje: Acero inox.

Material type A
 Impeller: Cast iron
 Bowl: AISI 304L
 Shaft: St. steel

Materiaux type A
 Roue: Fonte
 Corps: Fonte
 Arbre: Acier inox.

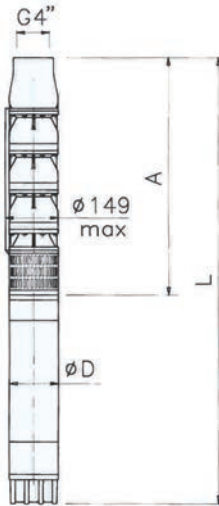

Tipo Type	Motor - Moteur		D mm	A mm	L mm	Peso Weight Poids (kg)
	KW	HP				
SD 0,46-1	4	5,5	90	449	1039	46
SD 0,46-2F2E	5,5	7,5	90	566	1270	58
SD 0,46-2	7,5	10	140	596	1232	73
SD 0,46-3F3	9,2	12,5	140	713	1382	81
SD 0,46-3	11	15	140	713	1424	84
SD 0,46-4	15	20	140	830	1531	96
SD 0,46-5	18,5	25	140	947	1778	111
SD 0,46-6	22	30	140	1064	1960	124
SD 0,46-7	26	35	140	1161	2295	168
SD 0,46-8	30	40	140	1298	2324	152
SD 0,46-10	37	50	140	1532	2926	198
SD 0,46-12	45	60	140	1766	3313	227

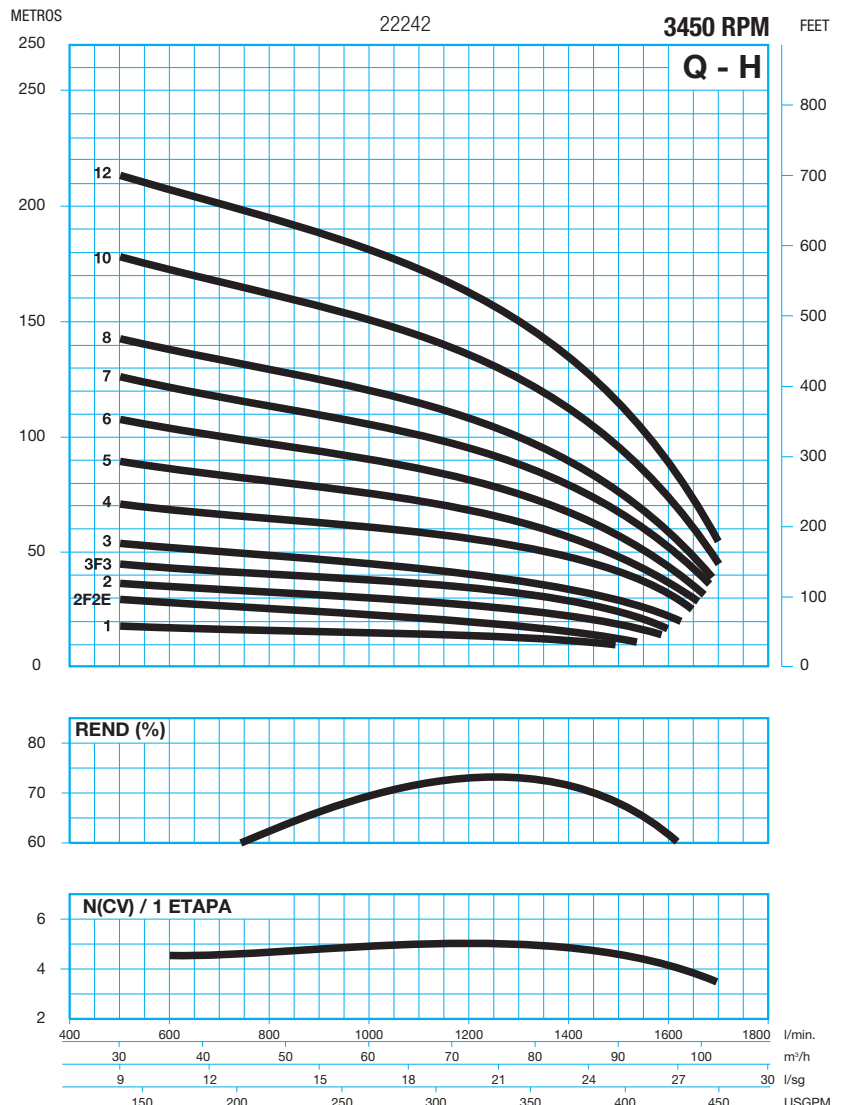

60HZ

BOMBA TIPO: SEMIAXIAL
 TEMP. MAX. LIQUIDO: 25°
 MAX. ARENA: 40 gr/m³
 SENTIDO ROT.: ANTIHORARIO
 VALV. RET.: INCORPORADA

PUMP TYPE: MIXED FLOW
 MAXI. TEMP. LIQUID: 25°
 SAND MAX.: 40 gr/m³
 ROTATION: C.C.W.
 CHECK VAL.: BUILT-IN

POMPE TYPE: SEMIAXIAL
 TEMP. MAX. LIQUIDE: 25°
 MAX. SABLE: 40 gr/m³
 SENS. ROT.: ANTIHORAIRE
 CLAPET RET.: INCORPORÉ

Tablas de selección / Selection charts / Tables de selection

Tipo Type	Motor - Moteur		l/min. m ³ /h	Caudal - Capacity - Debit					
	KW	HP		0	720	960	1080	1200	1440
SD 0,62 - 1	7,5	10	m.c.a.	37	32	27	25	22	16
SD 0,62 - 2F2	11	15		68	58	50	46	40	29
SD 0,62 - 2	15	20		75	63	55	50	45	32
SD 0,62 - 3F2	18,5	25		105	89	78	71	63	45
SD 0,62 - 4F4	22	30		135	115	101	92	81	58
SD 0,62 - 4F2	26	35		143	121	105	96	85	60
SD 0,62 - 5F4	30	40		173	147	128	117	103	73
SD 0,62 - 6F4	37	50		210	179	156	143	125	89
SD 0,62 - 6	45	60		225	190	164	151	134	95
SD 0,62 - 8	55	75		300	253	219	202	179	127
SD 0,62 - 11F3	75	100		401	340	294	271	239	170

Dimensiones / Dimensions / Dimensions

Materiales tipo A
 Impulsor: Hierro fundido
 Cuerpo: Hierro fundido
 Eje: Acero inox.

Material type A
 Impeller: Cast iron
 Bowl: AISI 304L
 Shaft: St. steel

Materiaux type A
 Roue: Fonte
 Corps: Fonte
 Arbre: Acier inox.

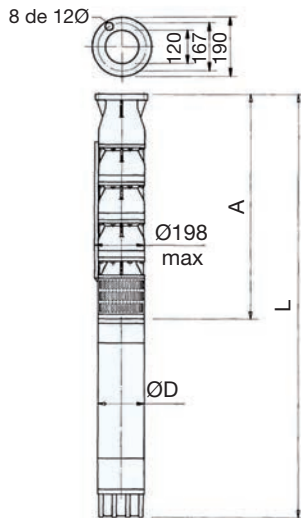

Tipo Type	Motor - Moteur		D mm	A mm	L mm	Peso Weight Poids (kg)
	KW	HP				
SD 0,62-1	7,5	10	140	607	1243	81
SD 0,62-2F2	11	15	140	743	1444	100
SD 0,62-2	15	20	140	743	1509	106
SD 0,62-3F2	18,5	25	140	879	1710	125
SD 0,62-4F4	22	30	140	1015	1911	143
SD 0,62-4F2	26	35	140	1015	2041	168
SD 0,62-5F4	30	40	140	1151	2177	168
SD 0,62-6F4	37	50	140	1287	2756	220
SD 0,62-6	45	60	192	1287	2477	276
SD 0,62-8	55	75	192	1559	2879	322
SD 0,62-11F3	75	100	192	1967	3517	396

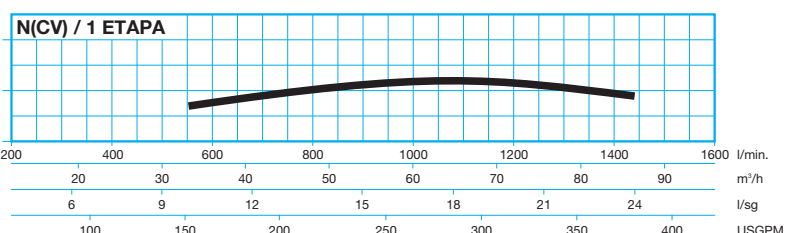
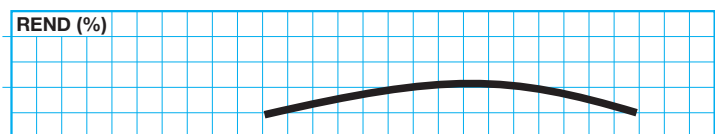
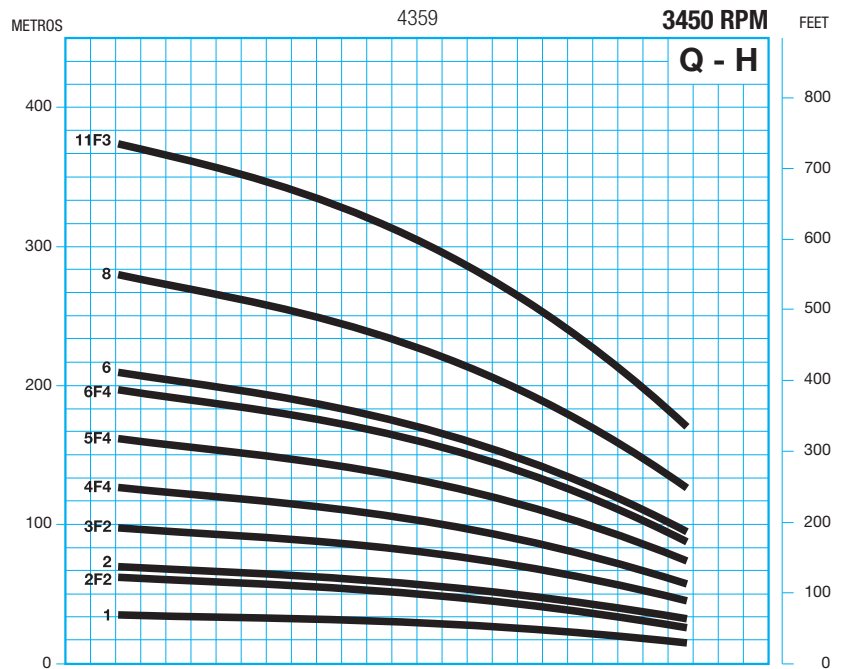

BOMBA TIPO: SEMIAXIAL
 TEMP. MAX. LIQUIDO: 25°
 MAX. ARENA: 40 gr/m³
 SENTIDO ROT.: ANTIHORARIO
 VALV. RET.: INCORPORADA

PUMP TYPE: MIXED FLOW
 MAXI. TEMP. LIQUID: 25°
 SAND MAX.: 40 gr/m³
 ROTATION: C.C.W.
 CHECK VAL.: BUILT-IN

POMPE TYPE: SEMIAXIAL
 TEMP. MAX. LIQUIDE: 25°
 MAX. SABLE: 40 gr/m³
 SENS. ROT.: ANTIHORAIRE
 CLAPET RET.: INCORPORÉ

Tablas de selección / Selection charts / Tables de selection

Tipo Type	Motor - Moteur		l/min. m ³ /h	Caudal - Capacity - Debit					
	KW	HP		0	960	1200	1440	1680	1920
SD 0,76 - 1F1	7,5	10	m.c.a.	30	26	23	20	16	9
SD 0,76 - 1	9	12,5		41	33	30	26	22	16
SD 0,76 - 2F2	15	20		60	52	46	40	32	17
SD 0,76 - 2	18,5	25		82	66	59	52	44	33
SD 0,76 - 3F3	22	30		91	78	69	60	48	26
SD 0,76 - 3F1	26	35		112	92	82	72	60	41
SD 0,76 - 4F3	30	40		132	111	99	86	69	42
SD 0,76 - 4	37	50		164	132	119	103	88	65
SD 0,76 - 5	45	60		205	166	148	129	109	81
SD 0,76 - 7F5	55	75		233	196	175	152	123	76
SD 0,76 - 9F4	75	100	326	269	240	210	173	116	

Dimensiones / Dimensions / Dimensions

Materiales tipo A
 Impulsor: Hierro fundido
 Cuerpo: Hierro fundido
 Eje: Acero inox.

Material type A
 Impeller: Cast iron
 Bowl: AISI 304L
 Shaft: St. steel

Materiaux type A
 Roue: Fonte
 Corps: Fonte
 Arbre: Acier inox.

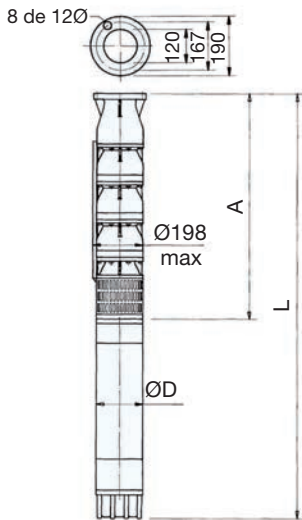

Tipo Type	Motor - Moteur		D mm	A mm	L mm	Peso Weight Poids (kg)
	KW	HP				
SD 0,76-1F1	7,5	10	140	607	1243	81
SD 0,76-1	9	12,5	140	743	1275	85
SD 0,76-2F2	15	20	140	743	1509	106
SD 0,76-2	18,5	25	140	879	1574	113
SD 0,76-3F3	22	30	140	1015	1775	131
SD 0,76-3F1	26	35	140	1015	1905	144
SD 0,76-4F3	30	40	140	1151	2041	156
SD 0,76-4	37	50	140	1287	2484	196
SD 0,76-5	45	60	192	1287	2341	264
SD 0,76-7F5	55	75	192	1559	2743	310
SD 0,76-9F4	75	100	192	1967	3245	372

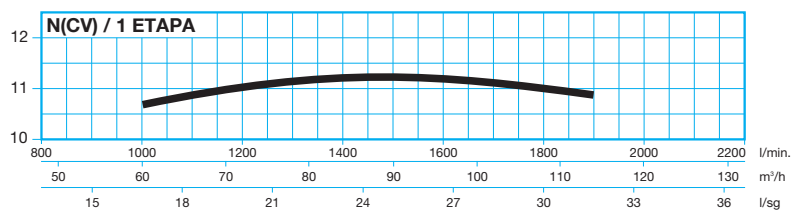
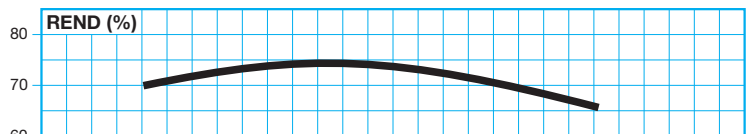
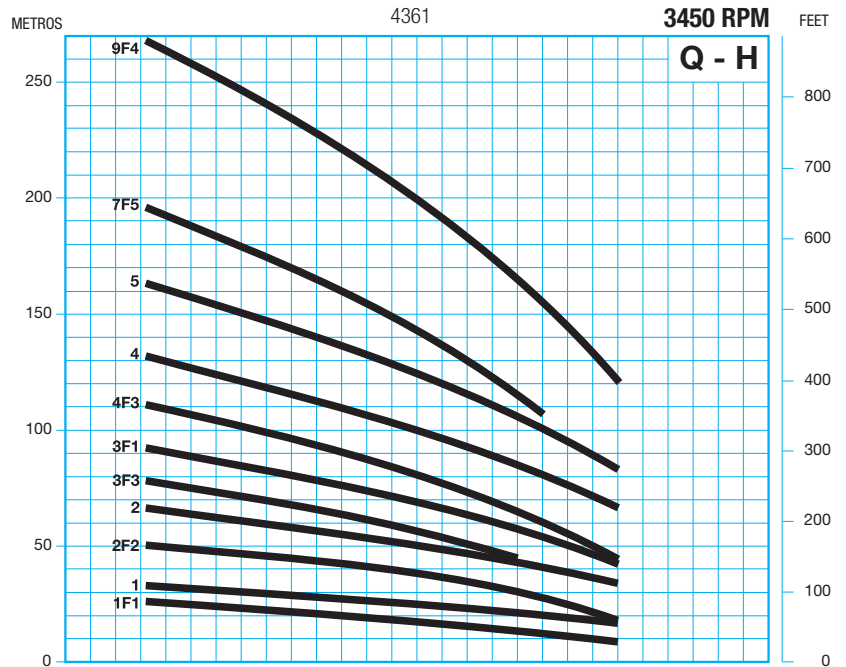

60Hz

BOMBA TIPO: SEMIAXIAL
 TEMP. MAX. LIQUIDO: 25°
 MAX. ARENA: 40 gr/m³
 SENTIDO ROT.: ANTIHORARIO
 VALV. RET.: INCORPORADA

PUMP TYPE: MIXED FLOW
 MAXI. TEMP. LIQUID: 25°
 SAND MAX.: 40 gr/m³
 ROTATION: C.C.W.
 CHECK VAL.: BUILT-IN

POMPE TYPE: SEMIAXIAL
 TEMP. MAX. LIQUIDE: 25°
 MAX. SABLE: 40 gr/m³
 SENS. ROT.: ANTIHORAIRE
 CLAPET RET.: INCORPORÉ

Tablas de selección / Selection charts / Tables de selection

Tipo Type	Motor - Moteur		l/min. m ³ /h	Caudal - Capacity - Debit					
	KW	HP		0	1200	1560	1800	1920	2280
				0	72	93	108	115	137
SD 0,82 - 1F1	9	12,5	m.c.a.	38	29	27	24	19	12
SD 0,82 - 1	13	17,5		48	36	33	30	29	22
SD 0,82 - 2F2	18,5	25		76	58	55	46	40	23
SD 0,82 - 2F1	22	30		86	65	60	53	49	34
SD 0,82 - 3F3	30	40		114	86	82	70	61	35
SD 0,82 - 4F4	37	50		152	115	109	93	80	46
SD 0,82 - 4F2	45	60		171	130	121	109	95	67
SD 0,82 - 5F3	55	75		209	158	148	131	116	79
SD 0,82 - 6F1	75	100		276	209	193	176	162	122

Dimensiones / Dimensions / Dimensions

Materiales tipo A
 Impulsor: Hierro fundido
 Cuerpo: Hierro fundido
 Eje: Acero inox.

Material type A
 Impeller: Cast iron
 Bowl: AISI 304L
 Shaft: St. steel

Materiaux type A
 Roue: Fonte
 Corps: Fonte
 Arbre: Acier inox.

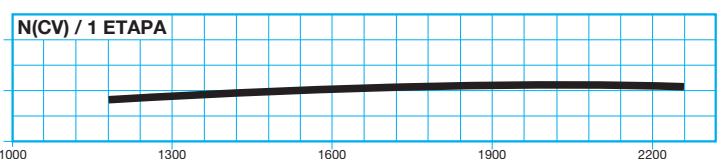
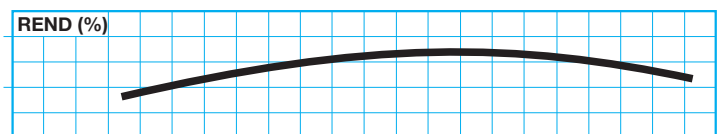
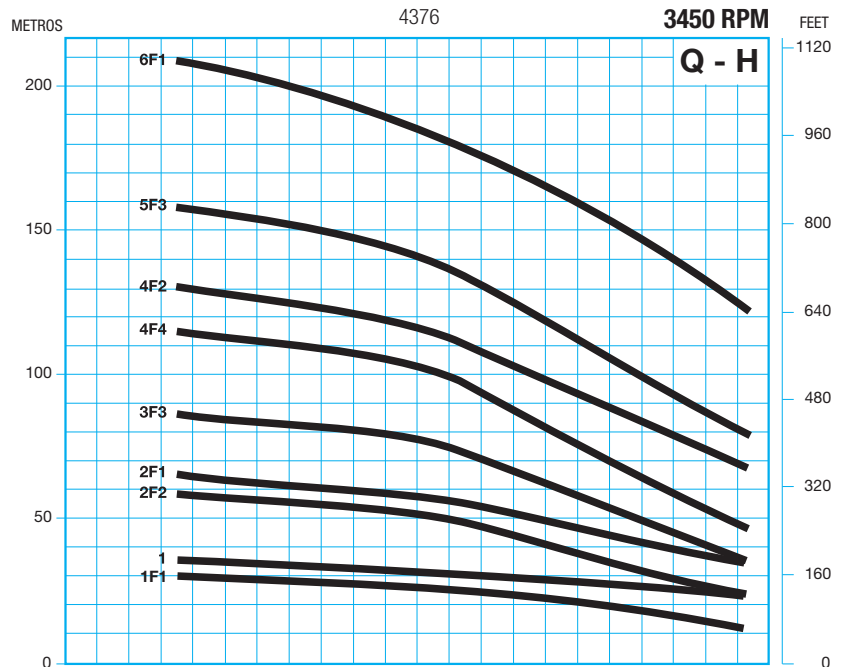
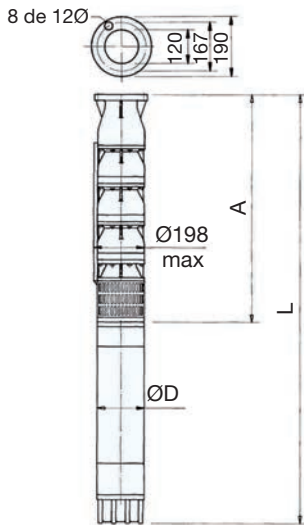

Tipo Type	Motor - Moteur		D mm	A mm	L mm	Peso Weight Poids (kg)
	KW	HP				
SD 0,82-1F1	9	12,5	140	607	1275	85
SD 0,82-1	13	17,5	140	607	1373	97
SD 0,82-2F2	18,5	25	140	743	1574	113
SD 0,82-2F1	22	30	140	743	1639	119
SD 0,82-3F3	30	40	140	879	1905	144
SD 0,82-4F4	37	50	140	1015	2484	216
SD 0,82-4F2	45	60	192	1015	2205	252
SD 0,82-5F3	55	75	192	1151	2471	286
SD 0,82-6F1	75	100	192	1287	2837	336

BOMBA TIPO: SEMIAXIAL
 TEMP. MAX. LIQUIDO: 25°
 MAX. ARENA: 40 gr/m³
 SENTIDO ROT.: ANTIHORARIO
 VALV. RET.: INCORPORADA

PUMP TYPE: MIXED FLOW
 MAXI. TEMP. LIQUID: 25°
 SAND MAX.: 40 gr/m³
 ROTATION: C.C.W.
 CHECK VAL.: BUILT-IN

POMPE TYPE: SEMIAXIAL
 TEMP. MAX. LIQUIDE: 25°
 MAX. SABLE: 40 gr/m³
 SENS. ROT.: ANTIHORAIRE
 CLAPET RET.: INCORPORÉ

Tablas de selección / Selection charts / Tables de selection

Tipo Type	Motor - Moteur		l/min. m ³ /h	Caudal - Capacity - Debit					
	KW	HP		0	1500	2500	2750	3000	3200
SD 0,88 - 1F1 E	11	15	m.c.a.	30	25	19	18	16	14
SD 0,88 - 1	14,7	20		36	30	25	23	21	19
SD 0,88 - 2F2 E	22,1	30		60	50	38	35	32	28
SD 0,88 - 2	29	40		72	60	50	46	42	39
SD 0,88 - 3F2 E	37	50		96	80	63	58	53	47
SD 0,88 - 3	44	60		108	90	75	69	63	58
SD 0,88 - 5F5 E	55	75		150	125	95	88	80	70
SD 0,88 - 5F3 E	66	90		162	135	107	99	90	81
SD 0,88 - 5	73,6	100		180	150	125	115	105	97

Dimensiones / Dimensions / Dimensions

Materiales tipo A
 Impulsor: Hierro fundido
 Cuerpo: Hierro fundido
 Eje: Acero inox.

Material type A
 Impeller: Cast iron
 Bowl: AISI 304L
 Shaft: St. steel

Materiaux type A
 Roue: Fonte
 Corps: Fonte
 Arbre: Acier inox.

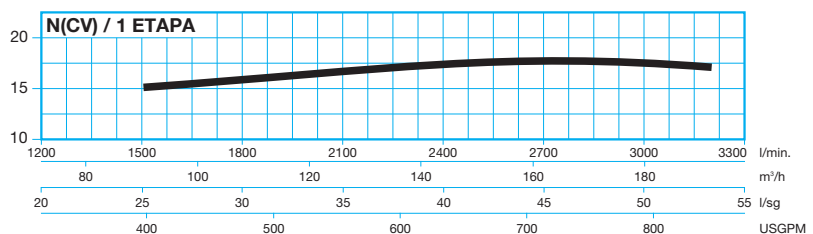
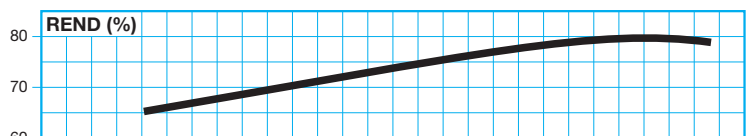
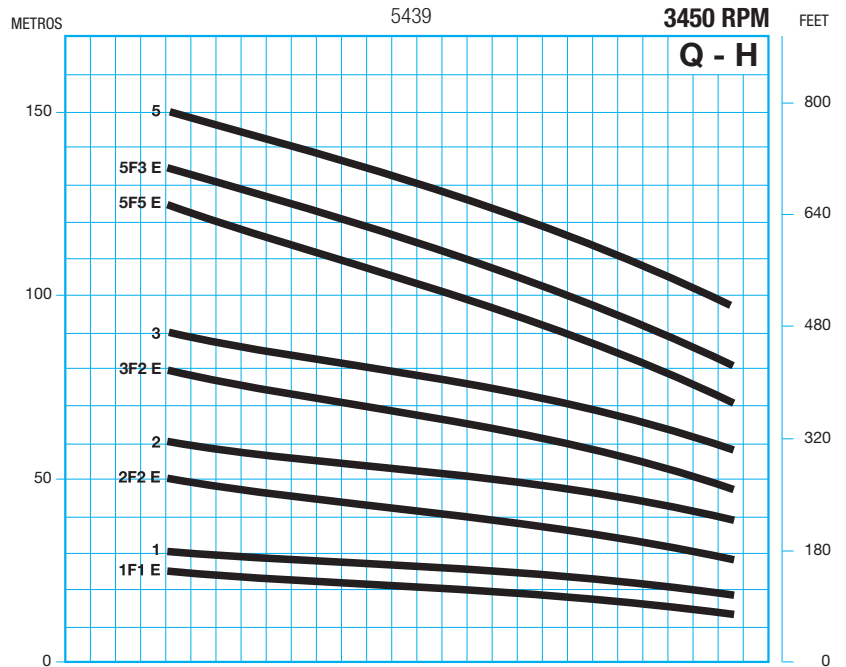
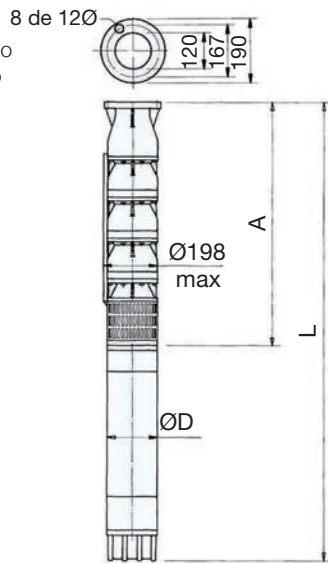

Tipo Type	Motor - Moteur		D mm	A mm	L mm	Peso Weight Poids (kg)
	KW	HP				
SD 0,88-1F1 E	11	15	142	580	1318	95
SD 0,88-1	14,7	20	142	580	1308	100
SD 0,88-2F2 E	22,1	30	142	716	1639	123
SD 0,88-2	29	40	142	716	1769	137
SD 0,88-3F2 E	37	50	142	852	1865	195
SD 0,88-3	44	60	192	852	1941	207
SD 0,88-5F5 E	55	75	192	1124	2355	257
SD 0,88-5F3 E	66	90	192	1124	2616	317
SD 0,88-5	73,6	100	192	1124	2701	366

60HZ

BOMBA TIPO: SEMIAXIAL
 TEMP. MAX. LIQUIDO: 25°
 MAX. ARENA: 40 gr/m³
 SENTIDO ROT.: ANTIHORARIO
 VALV. RET.: BAJO PEDIDO

PUMP TYPE: MIXED FLOW
 MAXI. TEMP. LIQUID: 25°
 SAND MAX.: 40 gr/m³
 ROTATION: C.C.W.
 CHECK VAL.: ON REQUEST

POMPE TYPE: SEMIAXIAL
 TEMP. MAX. LIQUIDE: 25°
 MAX. SABLE: 40 gr/m³
 SENS. ROT.: ANTIHORAIRE
 CLAPET RET.: SUR DEMENDE

Tablas de selección / Selection charts / Tables de selection

Tipo Type	Motor - Moteur		l/min. m ³ /h	Caudal - Capacity - Debit					
	KW	HP		0	1800	2100	2400	2700	3000
SD 1 - 1F1	13	17,5	m.c.a.	34	27	24	21	17	13
SD 1 - 1	18,5	25		41	35	33	30	27	24
SD 1 - 2F2	30	40		68	53	48	42	35	26
SD 1 - 2	37	50		82	69	66	60	55	48
SD 1 - 3F2	45	60		109	88	81	72	62	50
SD 1 - 3F3	52	70		116	96	90	81	72	60
SD 1 - 3	55	75		123	104	99	91	82	71
SD 1 - 4F1	66	90		157	130	123	112	99	84
SD 1 - 5F3	75	100		184	149	138	123	107	86
SD 1 - 5	92	125		205	173	166	151	137	119
SD 1 - 6	110	150		246	207	199	181	164	143
SD 1 - 7	130	175		287	242	232	212	192	166

Dimensiones / Dimensions / Dimensions

Materiales tipo B
 Impulsor: Bronce
 Cuerpo: Hierro fundido
 Eje: Acero inox.

Material type B
 Impeller: Bronze
 Bowl: Cast iron
 Shaft: St. steel

Materiaux type B
 Roue: Bronze
 Corps: Fonte
 Arbre: Acier inox.

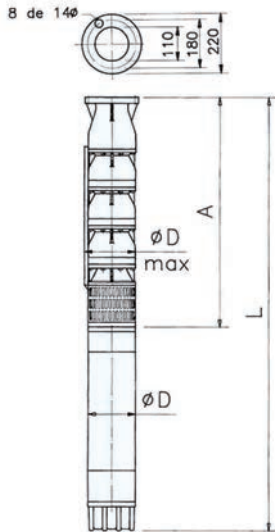

Tipo Type	Motor - Moteur		D mm	A mm	L mm	Peso Weight Poids (kg)
	KW	HP				
SD 1-1F1	13	17,5	140	723	1489	154
SD 1-1	18,5	25	140	745	1576	161
SD 1-2F2	30	40	140	883	1909	202
SD 1-2	37	50	140	883	2352	242
SD 1-3F2	45	60	192	1043	2233	320
SD 1-3F3	52	70	192	1043	2323	334
SD 1-3	55	75	192	1043	2363	342
SD 1-4F1	66	90	192	1203	2663	386
SD 1-5F3	75	100	192	1363	2913	424
SD 1-5	92	125	236	1363	2863	530
SD 1-6	110	150	236	1523	3213	595
SD 1-7	130	175	236	1683	3523	667

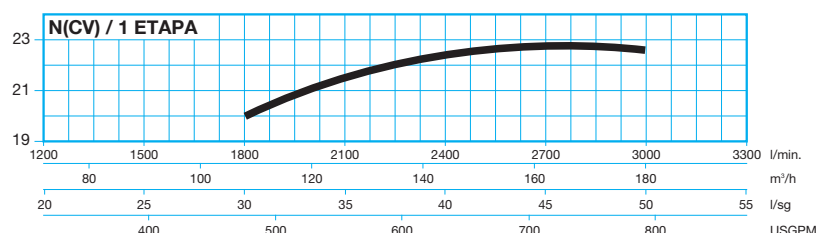
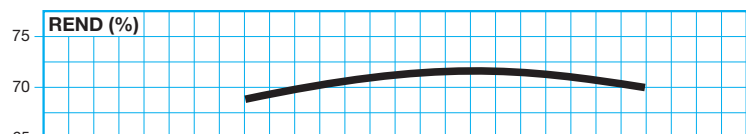
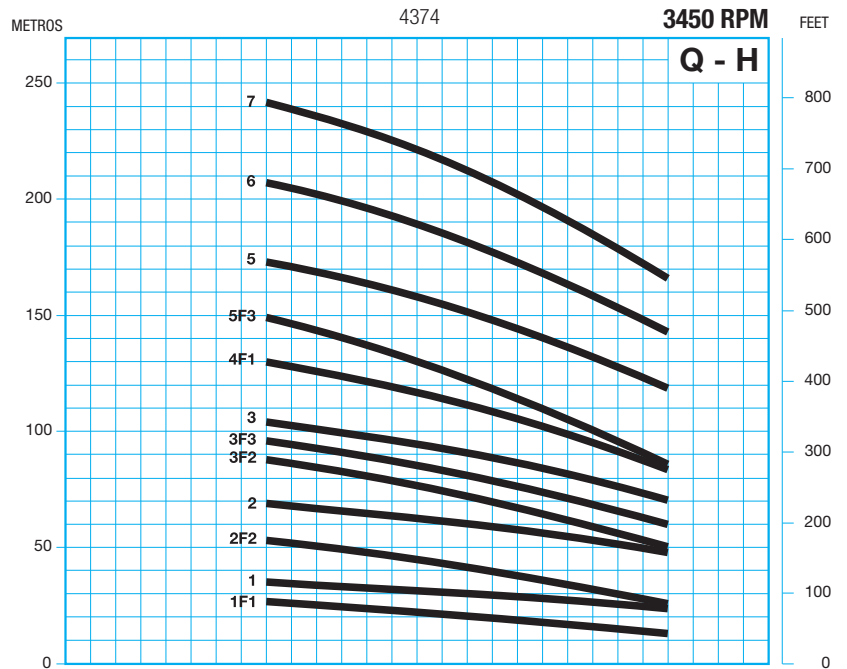

BOMBA TIPO: SEMIAXIAL
 TEMP. MAX. LIQUIDO: 25°
 MAX. ARENA: 40 gr/m³
 SENTIDO ROT.: ANTIHORARIO
 VALV. RET.: BAJO PEDIDO

PUMP TYPE: MIXED FLOW
 MAXI. TEMP. LIQUID: 25°
 SAND MAX.: 40 gr/m³
 ROTATION: C.C.W.
 CHECK VAL.: ON REQUEST

POMPE TYPE: SEMIAXIAL
 TEMP. MAX. LIQUIDE: 25°
 MAX. SABLE: 40 gr/m³
 SENS. ROT.: ANTIHORAIRE
 CLAPET RET.: SUR DEMENDE

Tablas de selección / Selection charts / Tables de selection

Tipo Type	Motor - Moteur		l/min. m ³ /h	Caudal - Capacity - Debit				
	KW	HP		0	1500	2500	3500	4000
				0	90	150	210	240
SD 1,8-1F1	29	40	m.c.a.	55	53	48	42	32
SD 1,8-1	36,8	50		62	59	56	49	45
SD 1,8-2F2	58,9	80		109	107	95	84	63
SD 1,8-2F1	66,2	90		117	112	104	91	76
SD 1,8-2	74	100		124	118	112	98	89
SD 1,8-3F3	92	125		164	160	143	125	95
SD 1,8-3	110	150		186	177	168	147	134
SD 1,8-4F3	129	175		226	219	199	174	140
SD 1,8-4	147	200		248	236	225	196	179
SD 1,8-5	184	250		310	295	281	245	223

Dimensiones / Dimensions / Dimensions

Materiales tipo A
 Impulsor: Hierro fundido
 Cuerpo: Hierro fundido
 Eje: Acero inox.

Material type A
 Impeller: Cast iron
 Bowl: Cast iron
 Shaft: St. steel

Materiaux type A
 Roue: Fonte
 Corps: Fonte
 Arbre: Acier inox.

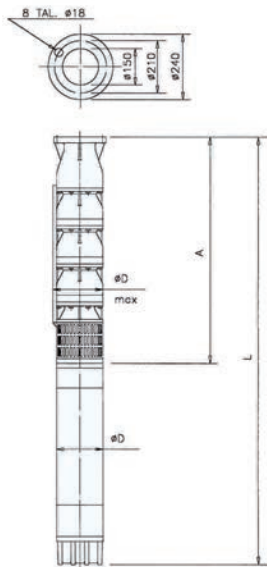

Tipo Type	Motor - Moteur		D máx.	D Motor-M	A mm	L mm	Peso Weight Poids (kg)
	KW	HP					
SD 1,8-1F1	29	40	250	142	710	1853	186
SD 1,8-1	36,8	50	250	142	710	1696	193
SD 1,8-2F2	58,9	80	250	192	895	2270	265
SD 1,8-2F1	66,2	90	250	192	895	2360	279
SD 1,8-2	74	100	250	192	895	2290	295
SD 1,8-3F3	92	125	250	192	1080	2590	404
SD 1,8-3	110	150	250	192	1080	2924	431
SD 1,8-4F3	129	175	250	236	1265	2875	484
SD 1,8-4	147	200	250	236	1265	3005	523
SD 1,8-5	184	250	250	236	1450	3372	616

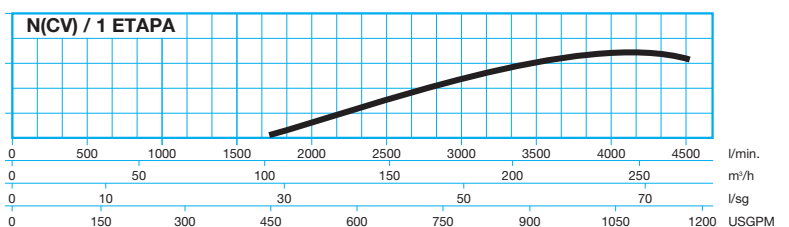
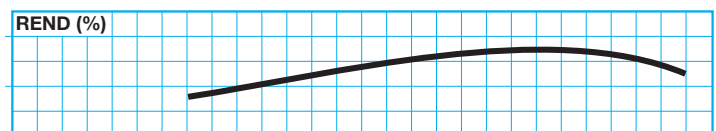
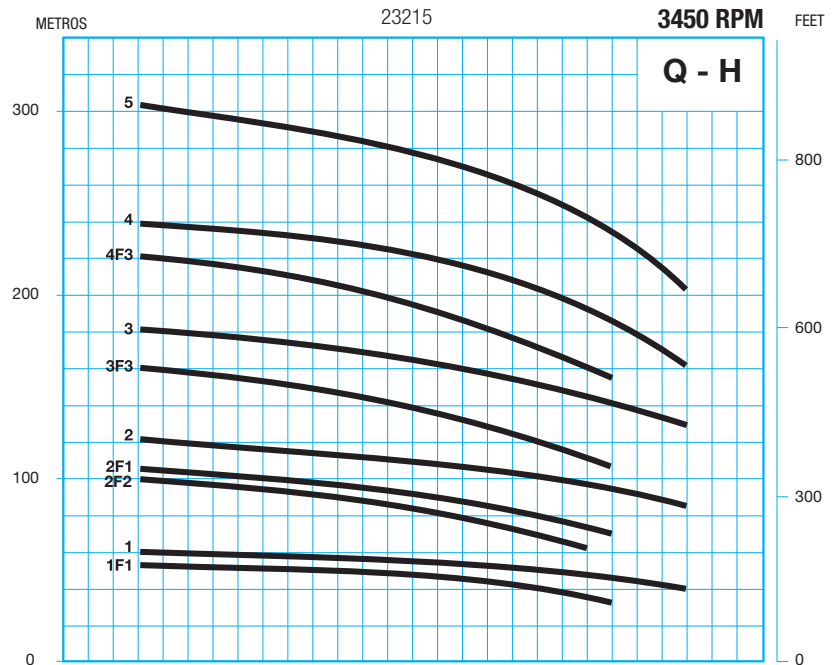

60HZ

BOMBA TIPO: SEMIAXIAL
 TEMP. MAX. LIQUIDO: 25°
 MAX. ARENA: 160 gr/m³
 SENTIDO ROT.: ANTIHORARIO
 VALV. RET.: BAJO PEDIDO

PUMP TYPE: MIXED FLOW
 MAXI. TEMP. LIQUID: 25°
 SAND MAX.: 160 gr/m³
 ROTATION: C.C.W.
 CHECK VAL.: ON REQUEST

POMPE TYPE: SEMIAXIAL
 TEMP. MAX. LIQUIDE: 25°
 MAX. SABLE: 160 gr/m³
 SENS. ROT.: ANTIHORAIRE
 CLAPET RET.: SUR DEMENDE

Tablas de selección / Selection charts / Tables de selection

Tipo Type	Motor - Moteur		l/min. m ³ /h	Caudal - Capacity - Debit				
	KW	HP		0	1500	2500	3500	4000
				0	90	150	210	240
SDX 1,8-1F1	29	40	m.c.a.	55	53	48	42	32
SDX 1,8-1	36,8	50		62	59	56	49	45
SDX 1,8-2F2	58,9	80		109	107	95	84	63
SDX 1,8-2F1	66,2	90		117	112	104	91	76
SDX 1,8-2	74	100		124	118	112	98	89
SDX 1,8-3F3	92	125		164	160	143	125	95
SDX 1,8-3	110	150		186	177	168	147	134
SDX 1,8-4F3	129	175		226	219	199	174	140
SDX 1,8-4	147	200		248	236	225	196	179
SDX 1,8-5	184	250		310	295	281	245	223

Dimensiones / Dimensions / Dimensions

Materiales tipo E
 Impulsor: AISI 316
 Cuerpo: AISI 316
 Eje: Acero inox.

Material type E
 Impeller: AISI 316
 Bowl: AISI 316
 Shaft: St. steel

Materiaux type E
 Roue: AISI 316
 Corps: AISI 316
 Arbre: Acier inox.

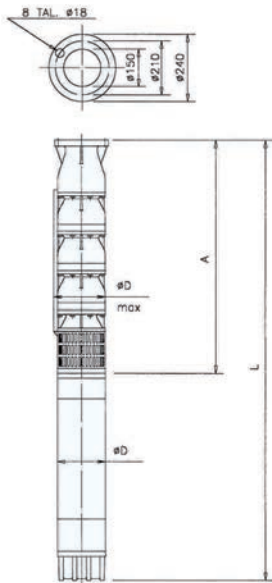

Tipo Type	Motor - Moteur		D máx.	D Motor-M	A mm	L mm	Peso Weight Poids (kg)
	KW	HP					
SDX 1,8-1F1	29	40	240	142	827	1853	147
SDX 1,8-1	36,8	50	254	192	710	1696	196
SDX 1,8-2F2	58,9	80	254	192	895	2270	307
SDX 1,8-2F1	66,2	90	254	192	895	2360	325
SDX 1,8-2	74	100	254	192	895	2290	300
SDX 1,8-3F3	92	125	260	236	1080	2590	475
SDX 1,8-3	110	150	260	236	1080	2924	516
SDX 1,8-4F3	129	175	260	236	1265	2875	588
SDX 1,8-4	147	200	260	236	1265	2735	625
SDX 1,8-5	184	250	276	236	1450	3372	717

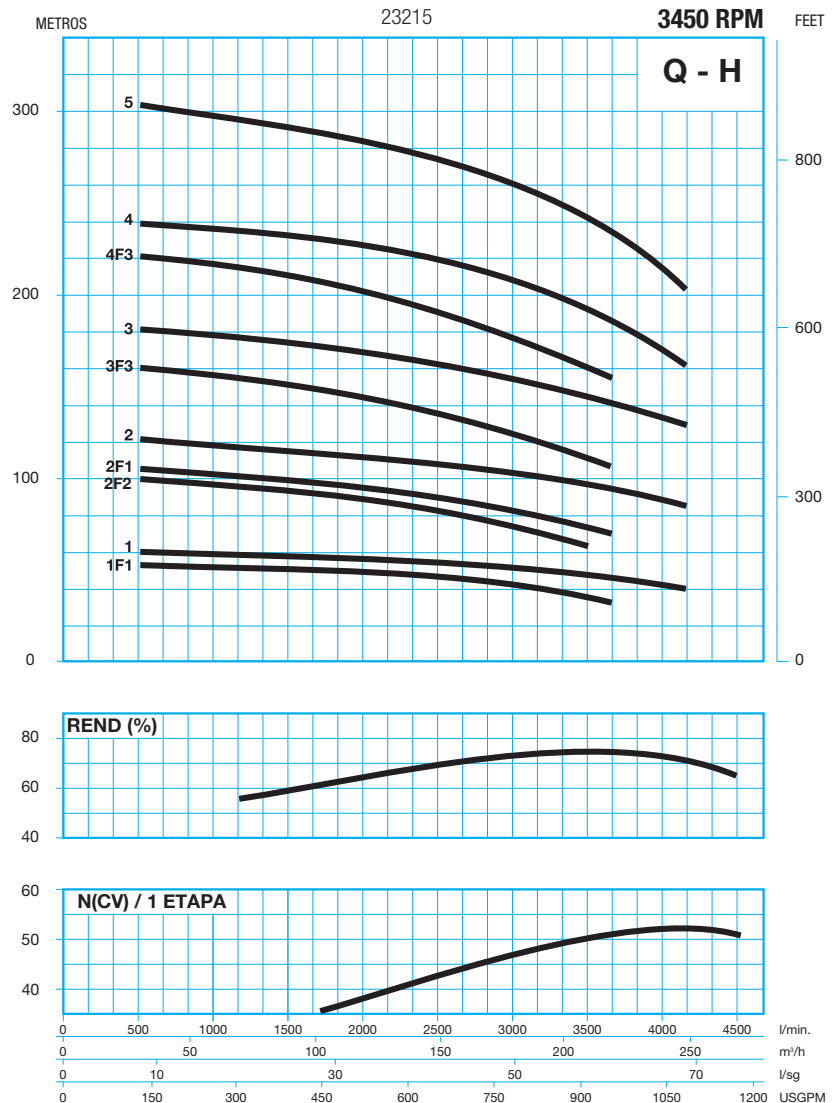

60HZ

BOMBA TIPO: SEMIAXIAL
 TEMP. MAX. LIQUIDO: 25°
 MAX. ARENA: 40 gr/m³
 SENTIDO ROT.: ANTIHORARIO
 VALV. RET.: BAJO PEDIDO

PUMP TYPE: MIXED FLOW
 MAXI. TEMP. LIQUID: 25°
 SAND MAX.: 40 gr/m³
 ROTATION: C.C.W.
 CHECK VAL.: ON REQUEST

POMPE TYPE: SEMIAXIAL
 TEMP. MAX. LIQUIDE: 25°
 MAX. SABLE: 40 gr/m³
 SENS. ROT.: ANTIHORAIRE
 CLAPET RET.: SUR DEMENDE

Tablas de selección / Selection charts / Tables de selection

Tipo Type	Motor - Moteur		l/min. m ³ /h	Caudal - Capacity - Debit					
	KW	HP		0	2700	3000	3900	4500	5100
SD 2,5-1F1	29	40	m.c.a.	53	43	41	33	25	16
SD 2,5-1	36,8	50		60	50	49	42	35	27
SD 2,5-2F2	58,9	80		107	86	82	66	50	31
SD 2,5-2F1	66,2	90		113	94	90	75	60	43
SD 2,5-2	74	100		120	101	97	84	69	54
SD 2,5-3F2	92	125		167	137	131	108	85	58
SD 2,5-3	110	150		181	151	146	125	104	81
SD 2,5-4F2	129	175		227	187	179	150	119	85
SD 2,5-4	147	200		241	202	195	167	138	108
SD 2,5-5	184	250		301	252	243	209	173	135
SD 2,5-6	221	300		361	302	292	251	207	162

Dimensiones / Dimensions / Dimensions

Materiales tipo A
 Impulsor: Hierro fundido
 Cuerpo: Hierro fundido
 Eje: Acero inox.

Material type A
 Impeller: Cast iron
 Bowl: Cast iron
 Shaft: St. steel

Matériaux type A
 Roue: Fonte
 Corps: Fonte
 Arbre: Acier inox.

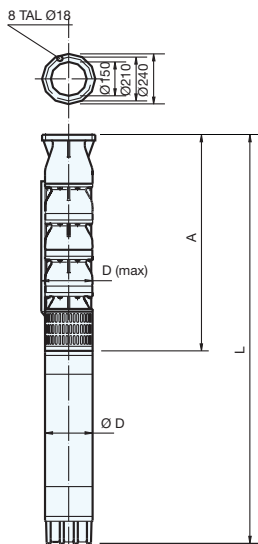

Tipo Type	Motor - Moteur		D máx.	D Motor-M	A mm	L mm	Peso Weight Poids (kg)
	KW	HP					
SD 2,5-1F1	29	40	250	142	710	1853	186
SD 2,5-1	36,8	50	250	142	710	1696	193
SD 2,5-2F2	58,9	80	250	192	895	2270	265
SD 2,5-2F1	66,2	90	250	192	895	2360	279
SD 2,5-2	74	100	250	192	895	2290	295
SD 2,5-3F2	92	125	250	192	1080	2590	404
SD 2,5-3	110	150	250	236	1080	2942	431
SD 2,5-4F2	129	175	250	236	1265	2875	484
SD 2,5-4	147	200	250	236	1265	3005	523
SD 2,5-5	184	250	250	236	1450	3372	616
SD 2,5-6	221	300	250	236	1635	3675	708

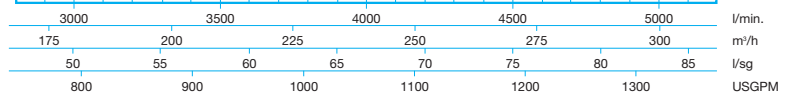
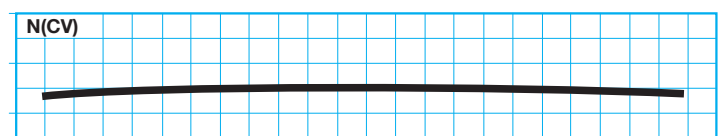
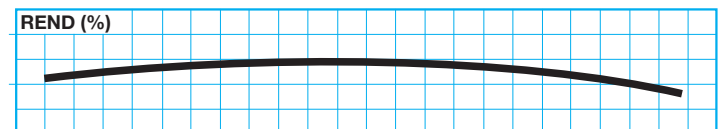
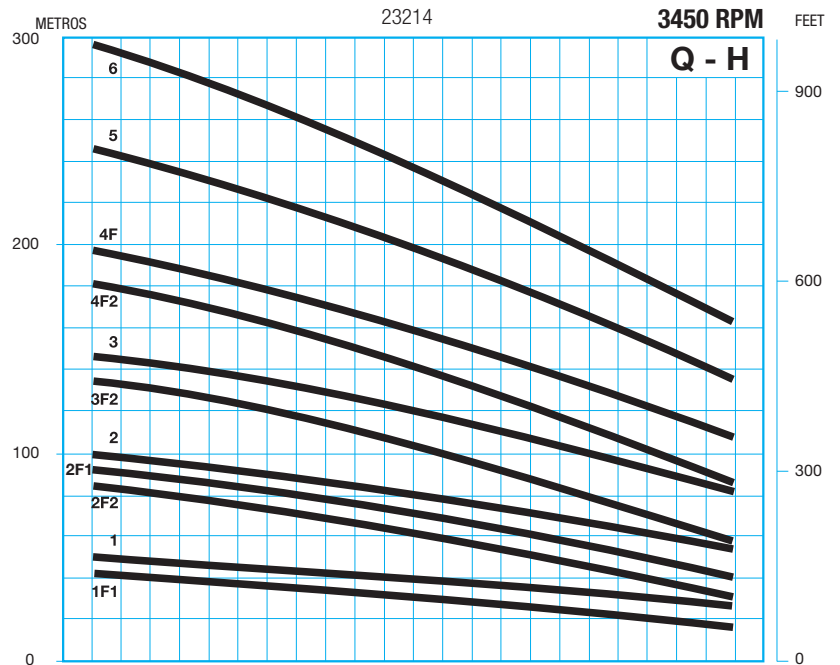

60Hz

BOMBA TIPO: SEMIAXIAL
 TEMP. MAX. LIQUIDO: 25°
 MAX. ARENA: 160 gr/m³
 SENTIDO ROT.: ANTIHORARIO
 VALV. RET.: BAJO PEDIDO

PUMP TYPE: MIXED FLOW
 MAXI. TEMP. LIQUID: 25°
 SAND MAX.: 160 gr/m³
 ROTATION: C.C.W.
 CHECK VAL.: ON REQUEST

POMPE TYPE: SEMIAXIAL
 TEMP. MAX. LIQUIDE: 25°
 MAX. SABLE: 160 gr/m³
 SENS. ROT.: ANTIHORAIRE
 CLAPET RET.: SUR DEMENDE

Tablas de selección / Selection charts / Tables de selection

Tipo Type	Motor - Moteur		l/min. m ³ /h	Caudal - Capacity - Debit					
	KW	HP		0	2700	3000	3900	4500	5100
SDX 2,5-1F1	29	40	m.c.a.	53	43	41	33	25	16
SDX 2,5-1	36,8	50		60	50	49	42	35	27
SDX 2,5-2F2	58,9	80		107	86	82	66	50	31
SDX 2,5-2F1	66,2	90		113	94	90	75	60	43
SDX 2,5-2	74	100		120	101	97	84	69	54
SDX 2,5-3F2	92	125		167	137	131	108	85	58
SDX 2,5-3	110	150		181	151	146	125	104	81
SDX 2,5-4F2	129	175		227	187	179	150	119	85
SDX 2,5-4	147	200		241	202	195	167	138	108
SDX 2,5-5	184	250		301	252	243	209	173	135
SDX 2,5-6	221	300		361	302	292	251	207	162

Dimensiones / Dimensions / Dimensions

Materiales tipo E
 Impulsor: AISI 316
 Cuerpo: AISI 316
 Eje: Acero inox.

Material type E
 Impeller: AISI 316
 Bowl: AISI 316
 Shaft: St. steel

Materiaux type E
 Roue: AISI 316
 Corps: AISI 316
 Arbre: Acier inox.

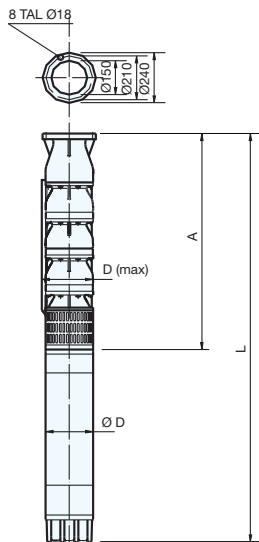

Tipo Type	Motor - Moteur		D máx.	D Motor-M	A mm	L mm	Peso Weight Poids (kg)
	KW	HP					
SDX 2,5-1F1	29	40	250	142	710	1853	186
SDX 2,5-1	36,8	50	250	142	710	1696	193
SDX 2,5-2F2	58,9	80	250	192	895	2270	265
SDX 2,5-2F1	66,2	90	250	192	895	2360	279
SDX 2,5-2	74	100	250	192	895	2290	295
SDX 2,5-3F2	92	125	250	192	1080	2590	404
SDX 2,5-3	110	150	250	192	1080	2924	431
SDX 2,5-4F2	129	175	250	236	1265	2875	484
SDX 2,5-4	147	200	250	236	1265	3005	523
SDX 2,5-5	184	250	250	236	1450	3372	616
SDX 2,5-6	221	300	250	236	1635	3675	708

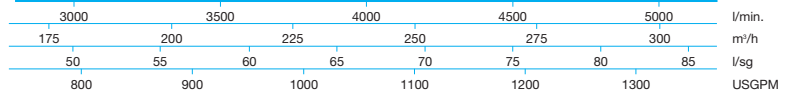
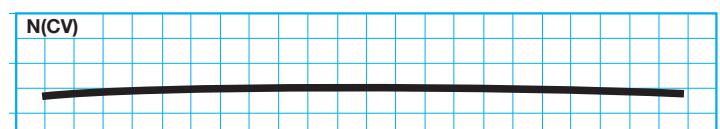
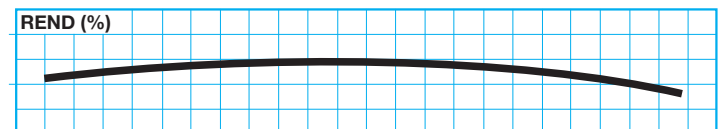
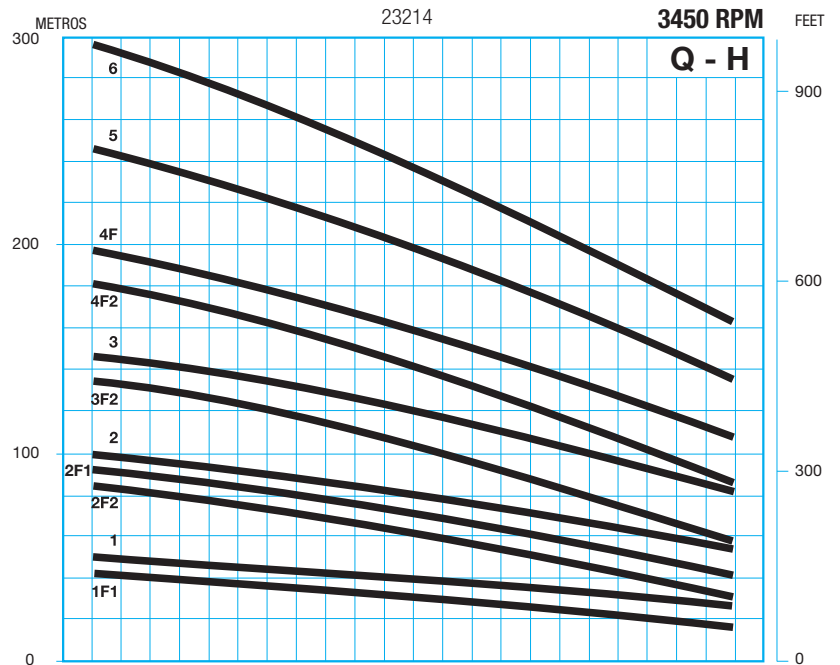

BOMBA TIPO: SEMIAXIAL
 TEMP. MAX. LIQUIDO: 25°
 MAX. ARENA: 40 gr/m³
 SENTIDO ROT.: ANTIHORARIO
 VALV. RET.: BAJO PEDIDO

PUMP TYPE: MIXED FLOW
 MAXI. TEMP. LIQUID: 25°
 SAND MAX.: 40 gr/m³
 ROTATION: C.C.W.
 CHECK VAL.: ON REQUEST

POMPE TYPE: SEMIAXIAL
 TEMP. MAX. LIQUIDE: 25°
 MAX. SABLE: 40 gr/m³
 SENS. ROT.: ANTIHORAIRE
 CLAPET RET.: SUR DEMENDE

Tablas de selección / Selection charts / Tables de selection

Tipo Type	Motor - Moteur		l/min. m ³ /h	Caudal - Capacity - Debit						
	KW	HP		0	3000	3600	4200	4800	5400	6000
				0	180	216	252	288	324	360
SD 2,6-1F1E	45	60	m.c.a.	53	45	43	40	37	32	24
SD 2,6-1F1	55	75		60	53	50	48	43	39	32
SD 2,6-1	55	75		70	59	56	53	50	46	39
SD 2,6-2F2E	75	100		106	84	82	76	71	59	46
SD 2,6-2F2	90	125		120	104	99	93	85	76	63
SD 2,6-2F1	110	150		130	112	108	102	95	86	72
SD 2,6-2	110	150		140	118	114	109	102	92	79
SD 2,6-3F3E	150	200		159	143	137	128	118	102	81
SD 2,6-3F2	166	225		190	168	161	153	142	127	107
SD 2,6-3	166	225		210	180	173	166	156	140	121
SD 2,6-4F3	223	300		250	222	212	201	187	168	140

Dimensiones / Dimensions / Dimensions

Materiales tipo A
 Impulsor: Hierro fundido
 Cuerpo: Hierro fundido
 Eje: Acero inox.

Material type A
 Impeller: Cast iron
 Bowl: Cast iron
 Shaft: St. steel

Materiaux type A
 Roue: Fonte
 Corps: Fonte
 Arbre: Acier inox.

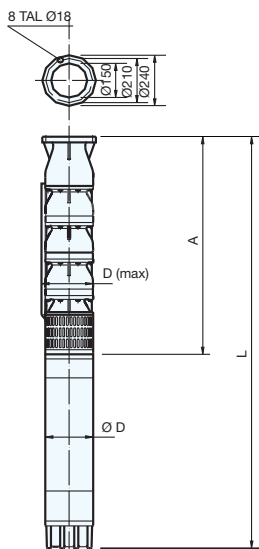

Tipo Type	Motor - Moteur		D máx.	D Motor-M	A mm	L mm	Peso Weight Poids (kg)
	KW	HP					
SD 2,6-1F1E	45	60	250	142	710	1911	220
SD 2,6-1F1	55	75	250	192	710	2101	232
SD 2,6-1	55	75	250	192	710	2101	232
SD 2,6-2F2E	75	100	250	192	895	2265	360
SD 2,6-2F2	90	125	250	192	895	2325	379
SD 2,6-2F1	110	150	250	192	895	2739	404
SD 2,6-2	110	150	250	192	895	2739	404
SD 2,6-3F3E	150	200	250	236	1080	2820	498
SD 2,6-3F2	166	225	250	236	1080	3002	566
SD 2,6-3	166	225	250	236	1080	3002	566
SD 2,6-4F3	223	300	250	236	1265	3305	633

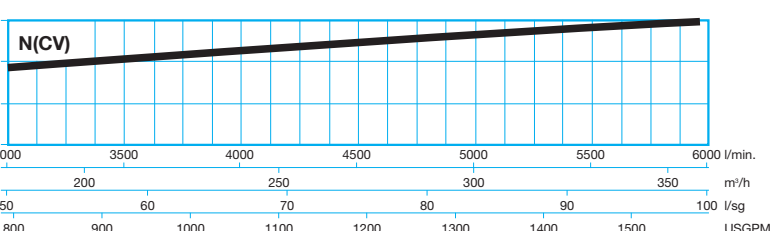
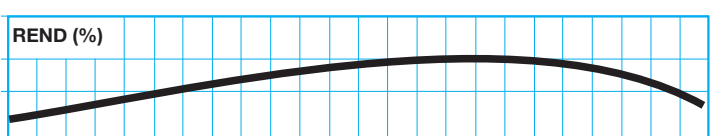
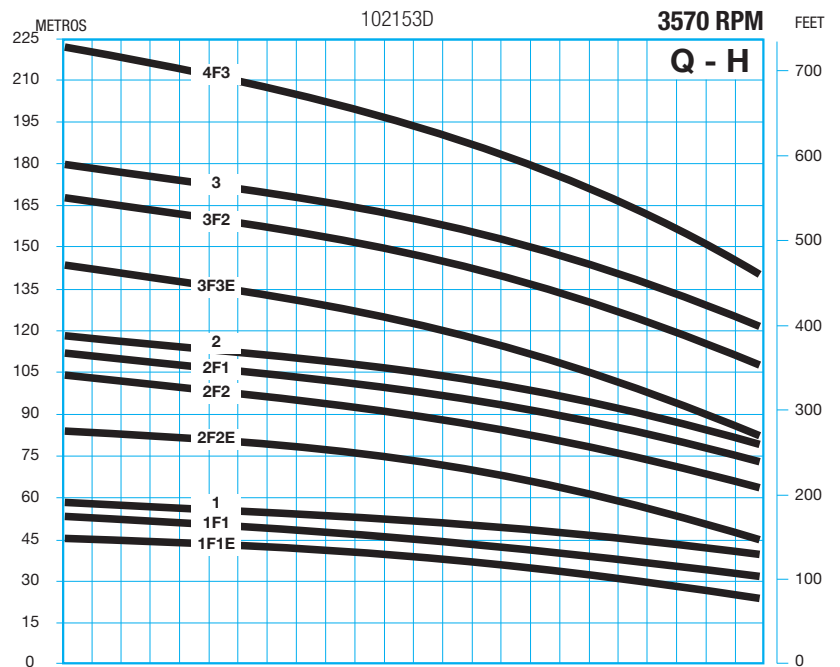

60HZ

BOMBA TIPO: SEMIAXIAL
 TEMP. MAX. LIQUIDO: 25°
 MAX. ARENA: 160 gr/m³
 SENTIDO ROT.: ANTIHORARIO
 VALV. RET.: BAJO PEDIDO

PUMP TYPE: MIXED FLOW
 MAXI. TEMP. LIQUID: 25°
 SAND MAX.: 160 gr/m³
 ROTATION: C.C.W.
 CHECK VAL.: ON REQUEST

POMPE TYPE: SEMIAXIAL
 TEMP. MAX. LIQUIDE: 25°
 MAX. SABLE: 160 gr/m³
 SENS. ROT.: ANTIHORAIRE
 CLAPET RET.: SUR DEMENDE

Tablas de selección / Selection charts / Tables de selection

Tipo Type	Motor - Moteur		l/min. m ³ /h	Caudal - Capacity - Debit						
	KW	HP		0	3000	3600	4200	4800	5400	6000
				0	180	216	252	288	324	360
SDX 2,6-1F1E	45	60	m.c.a.	53	45	43	40	37	32	24
SDX 2,6-1F1	55	75		60	53	50	48	43	39	32
SDX 2,6-1	55	75		70	59	56	53	50	46	39
SDX 2,6-2F2E	75	100		106	84	82	76	71	59	46
SDX 2,6-2F2	90	125		120	104	99	93	85	76	63
SDX 2,6-2F1	110	150		130	112	108	102	95	86	72
SDX 2,6-2	110	150		140	118	114	109	102	92	79
SDX 2,6-3F3E	150	200		159	143	137	128	118	102	81
SDX 2,6-3F2	166	225		190	168	161	153	142	127	107
SDX 2,6-3	166	225		210	180	173	166	156	140	121
SDX 2,6-4F3	223	300		250	222	212	201	187	168	140

Dimensiones / Dimensions / Dimensions

Materiales tipo E
 Impulsor: AISI 316
 Cuerpo: AISI 316
 Eje: Acero inox.

Material type E
 Impeller: AISI 316
 Bowl: AISI 316
 Shaft: St. steel

Materiaux type E
 Roue: AISI 316
 Corps: AISI 316
 Arbre: Acier inox.

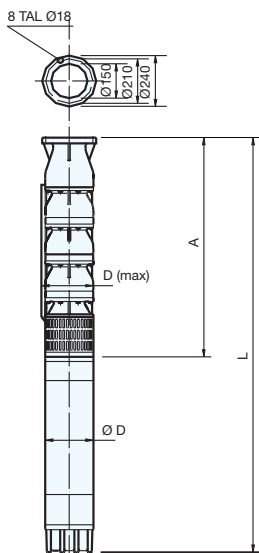

Tipo Type	Motor - Moteur		D máx.	D Motor-M	A mm	L mm	Peso Weight Poids (kg)
	KW	HP					
SDX 2,6-1F1E	45	60	250	142	710	1911	220
SDX 2,6-1F1	55	75	250	192	710	2101	232
SDX 2,6-1	55	75	250	192	710	2101	232
SDX 2,6-2F2E	75	100	250	192	895	2265	360
SDX 2,6-2F2	90	125	250	192	895	2325	379
SDX 2,6-2F1	110	150	250	192	895	2739	404
SDX 2,6-2	110	150	250	192	895	2739	404
SDX 2,6-3F3E	150	200	250	236	1080	2820	498
SDX 2,6-3F2	166	225	250	236	1080	3002	566
SDX 2,6-3	166	225	250	236	1080	3002	566
SDX 2,6-4F3	223	300	250	236	1265	3305	633

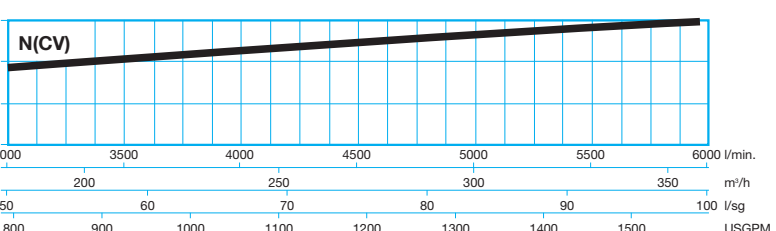
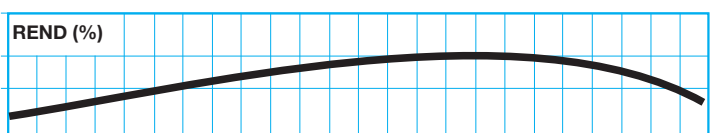
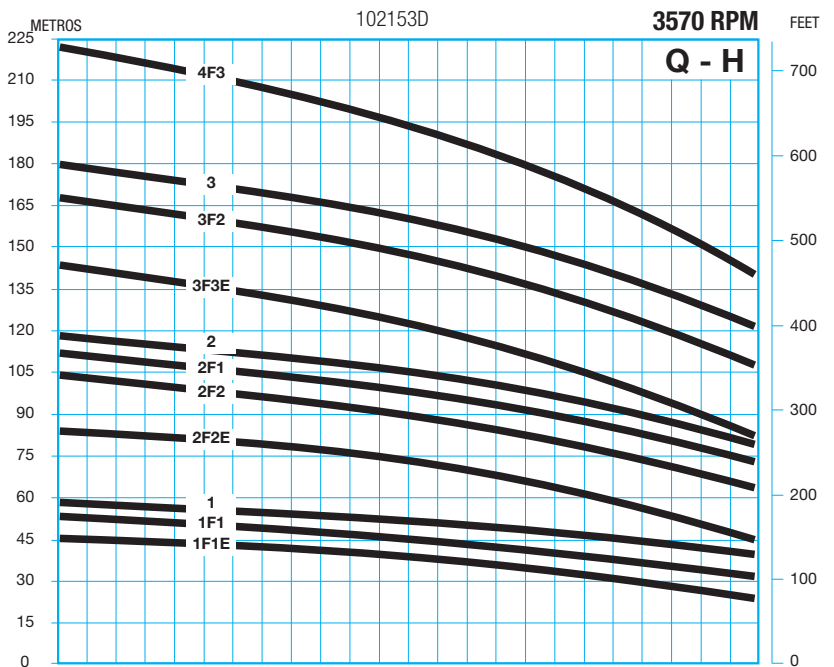

BOMBA TIPO: SEMIAXIAL
 TEMP. MAX. LIQUIDO: 25°
 MAX. ARENA: 40 gr/m³
 SENTIDO ROT.: ANTIHORARIO
 VALV. RET.: BAJO PEDIDO

PUMP TYPE: MIXED FLOW
 MAXI. TEMP. LIQUID: 25°
 SAND MAX.: 40 gr/m³
 ROTATION: C.C.W.
 CHECK VAL.: ON REQUEST

POMPE TYPE: SEMIAXIAL
 TEMP. MAX. LIQUIDE: 25°
 MAX. SABLE: 40 gr/m³
 SENS. ROT.: ANTIHORAIRE
 CLAPET RET.: SUR DEMENDE

Tablas de selección / Selection charts / Tables de selection

Tipo Type	Motor - Moteur		l/min. m ³ /h	Caudal - Capacity - Debit					
	KW	HP		0	4800	5400	5700	6300	6600
SD 5 - 1	44	60	m.c.a.	46	37	36	35	30	27
SD 5 - 2	92	125		92	75	72	69	60	55
SD 5 - 3	129	175		138	112	108	104	91	82
SD 5 - 4	185	250		184	150	144	138	121	109
SD 5 - 5	220	300		230	187	180	173	151	137

Dimensiones / Dimensions / Dimensions

Materiales tipo A
 Impulsor: Bronce
 Cuerpo: Hierro fundido
 Eje: Acero inox.

Material type A
 Impeller: Bronze
 Bowl: Cast iron
 Shaft: St. steel

Materiaux type A
 Roue: Bronze
 Corps: Fonte
 Arbre: Acier inox.

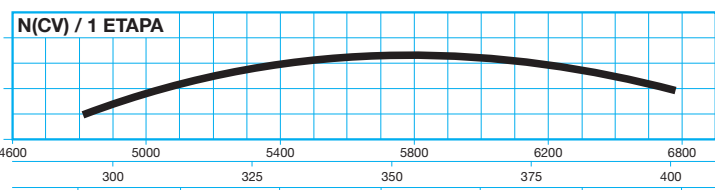
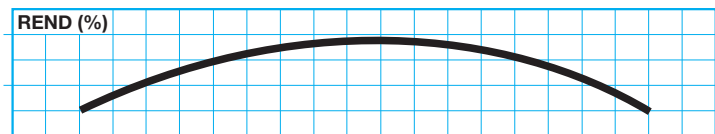
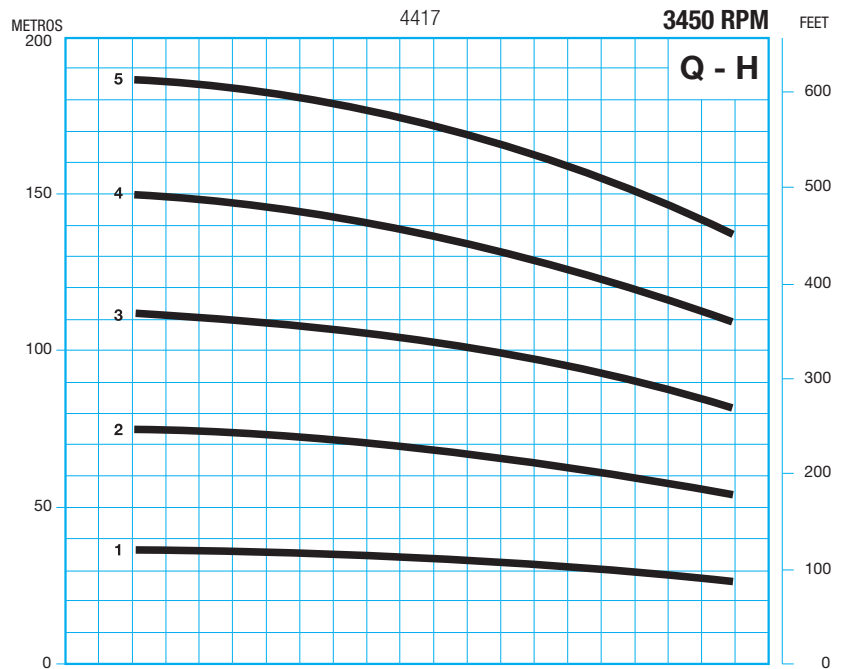
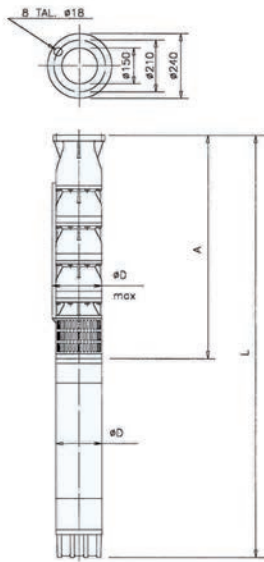

Tipo Type	Motor - Moteur		D mm	A mm	L mm	Peso Weight Poids (kg)
	KW	HP				
SD 5-1	44	60	192	620	1810	286
SD 5-2	92	125	192	775	2275	481
SD 5-3	129	175	236	868	2708	587
SD 5-4	185	250	236	1150	2738	729
SD 5-5	220	300	276	1305	3043	810

BOMBA TIPO: SEMIAXIAL
 TEMP. MAX. LIQUIDO: 25°
 MAX. ARENA: 40 gr/m³
 SENTIDO ROT.: ANTIHORARIO
 VALV. RET.: BAJO PEDIDO

PUMP TYPE: MIXED FLOW
 MAXI. TEMP. LIQUID: 25°
 SAND MAX.: 40 gr/m³
 ROTATION: C.C.W.
 CHECK VAL.: ON REQUEST

POMPE TYPE: SEMIAXIAL
 TEMP. MAX. LIQUIDE: 25°
 MAX. SABLE: 40 gr/m³
 SENS. ROT.: ANTIHORAIRE
 CLAPET RET.: SUR DEMENDE

Tablas de selección / Selection charts / Tables de selection

Tipo Type	Motor - Moteur		l/min.	Caudal - Capacity - Debit					
	KW	HP		0	7800	8400	9600	10800	12000
			m ³ /h	0	468	504	576	648	720
SD 9 - 1	92	125	m.c.a.	53	48	46	39	33	26
SD 9 - 2	185	250		106	95	92	78	66	52

Dimensiones / Dimensions / Dimensions

Materiales tipo B
 Impulsor: Bronce
 Cuerpo: Hierro fundido
 Eje: Acero inox.

Material type B
 Impeller: Bronze
 Bowl: Cast iron
 Shaft: St. steel

Matériaux type B
 Roue: Bronze
 Corps: Fonte
 Arbre: Acier inox.

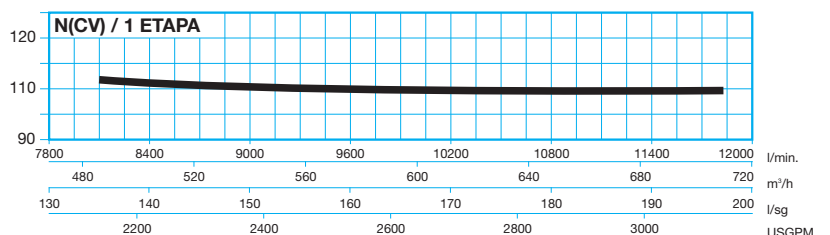
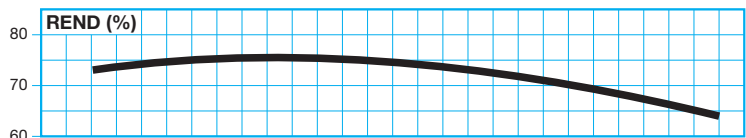
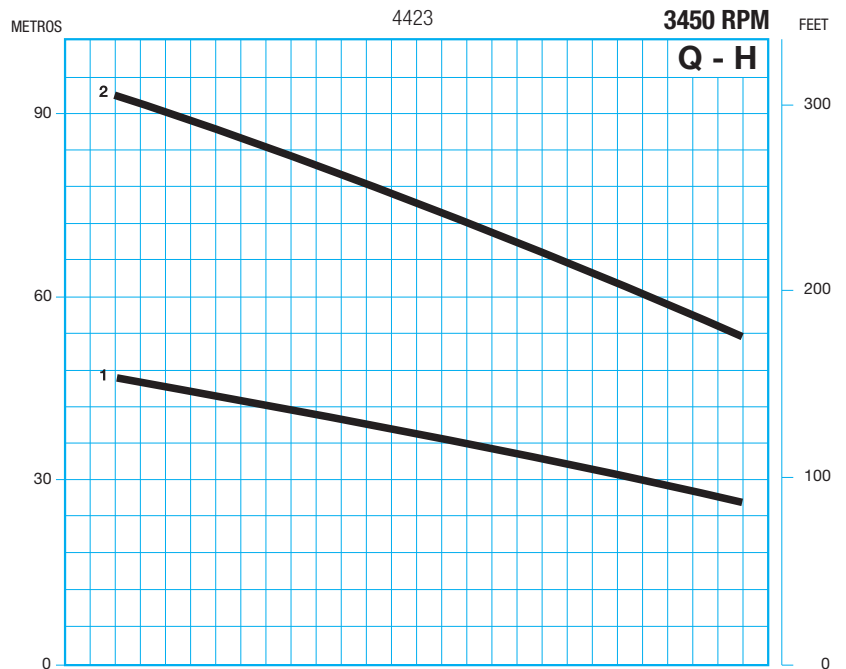
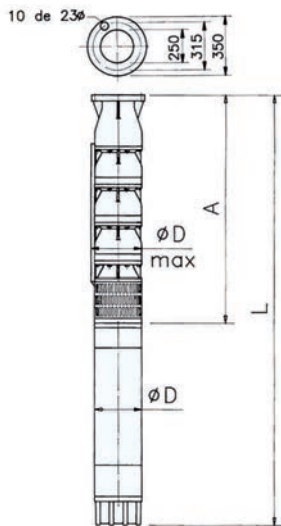

Tipo Type	Motor - Moteur		D mm	A mm	L mm	Peso Weight Poids (kg)
	KW	HP				
SD 9-1	92	125	236	887	2387	426
SD 9-2	185	250	276	1127	2715	585

**Características técnicas****motores sumergibles 50Hz y 60Hz**

Los motores sumergibles son de tipo asíncrono IP-68, rotor en jaula de ardilla y montado sobre cojinetes especiales, soportando el empuje axial de la bomba mediante un cojinete axial ampliamente dimensionado. El bobinado estático es inundado en aceite ó agua según se trate de 4-6-8-10-12", en todos los casos los cojinetes son lubricados por el líquido interno y no necesitan mantenimiento. Este líquido además de lubricar los cojinetes, favorece la refrigeración general del motor debido al intercambio térmico con el agua del pozo. Una membrana elástica compensa la diferencia de presiones entre el interior y el exterior del motor.

Estos motores están fabricados por las más prestigiosas firmas especializadas en este tipo de motores.

Las bridas de acoplamiento son normalizadas, están diseñadas de acuerdo con las normas NEMA, simplificándose así las operaciones de mantenimiento y reparación.

Technical features of submersible motors 50HZ and 60HZ

Submersible motors are asynchronous, IP-68, shorted rotor and mounted on special bearings, supporting the axial thrust of the pump through a generous sized axial bearing.

The stator winding is flooded in water, oil or encapsulated in resin depending on whether it is a rewinding or encapsulated motor, in all case the bearings are lubricated by the internal liquid and need not maintenance. This liquid in addition to lubricate bearings, favours the general cooling of the motor due to heat exchange with the well water. An elastic membrane compensates the pressure difference between inside and outside of the motor.

This motor are manufactured by the most prestigious firms specialized in this type of motors.

The coupling flanges are standard, designed in accordance to NEMA standard, simplifying maintenance and repair.

Caractéristiques techniques**des moteurs submersibles 50Hz et 60Hz**

Les moteurs submersibles sont de type asynchrone, IP-68, rotor en court-circuit et monté sur coussinets spéciaux, supportant la poussée axiale de la pompe grâce à un coussinet axiale largement dimensionnés. Le bobinage du stator est inondé en eau, l'huile ou encapsulé dans une résine selon qu'il s'agit d'un moteur rebobinable ou encapsulé, dans tous les cas les coussinets sont lubrifiés par le liquide interne et ne nécessitent un entretien. Ce liquide en outre de lubrifier les coussinets, favorise la réfrigération général du moteur à cause de l'échange thermique avec l'eau du puits. Une membrane élastique compense la différence de pressions entre l'intérieur et à l'extérieur du moteur.

Ces moteurs sont fabriqués par les plus prestigieuses firmes spécialisées dans ce type de moteurs.

Les brides d'accouplement sont normalisées, sont conçues en accord avec les normes NEMA, simplifiant ainsi les opérations de maintien et de réparation.

Motores monofásicos en baño de aceite-rebobinables 4" **CORMOTOR ACEITE**
4" single-phase motors in oil bath-rewindable **CORMOTOR OIL**
Moteurs monophasés dans un bain d'huile-rebobinables 4" **CORMOTOR HUILE**

Motor Tipo	Motor P2		In (A) 230 V	Rend. %	Cos. φ	RPM	I arr A	Ts/Tn	Carga axial (KN)	Peso Kg	Cond. μ F	Long. (mm)
	kW	HP										
4" - 0,5M	0,37	0,5	3,2	54,9	0,87	2850	11,8	0,75	1500	9	15	363
4" - 0,75M	0,55	0,75	4,5	63,7	0,88	2850	12,4	0,63	1500	9,8	20	383
4" - 1M	0,75	1	6,4	63	0,84	2850	23,2	0,62	1500	11	25	408
4" - 1,5M	1,1	1,5	7,8	70,3	0,91	2850	31,8	0,62	2500	13	35	443
4" - 2M	1,5	2	10,8	68,9	0,92	2850	41	0,62	2500	15	45	488
4" - 3M	2,2	3	13,9	77,5	0,93	2850	62	0,64	2500	20,5	60	578

Motores trifásicos en baño de aceite-rebobinables 4" **CORMOTOR ACEITE**
4" three-phase motors in oil bath-rewindable **CORMOTOR OIL**
Moteurs triphasés dans un bain d'huile-rebobinables 4" **CORMOTOR HUILE**

Hz	Motor Tipo	Motor P2		Tensión (V)	I _n (A)	Rend. %	Cos. φ	RPM	I _{arr.} A	Carga axial (KN)	Peso Kg	Long. (mm)
		kW	HP									
50 Hz	CORMOTOR 4" 0,5	0,37	0,5	230	2,5	58	0,72	2840	8,6	1,5	6,5	325
		0,37	0,5	400	1,6	58	0,72	2840	5	1,5	6,5	325
		0,37	0,5	415	1,1	58	0,71	2830	4	1,5	6,5	325
60 Hz	CORMOTOR 4" 0,5	0,37	0,5	400	1,6	68	0,72	3420	9	2	6,7	330
50 Hz	CORMOTOR 4" 75	0,55	0,75	230	3,3	62	0,75	2830	12,2	1,5	7	325
		0,55	0,75	400	2	62	0,75	2830	7	1,5	7	325
		0,55	0,75	415	1,6	62	0,72	2830	6	1,5	7	325
60 Hz	CORMOTOR 4" 75	0,55	0,75	400	2,2	69	0,75	3400	11	2	7,4	346
50 Hz	CORMOTOR 4" 1	0,75	1	380	2	79,4	0,71	2850	9,6	1,5	7,3	408
		0,75	1	400	2,1	79,4	0,66	2850	6,6	1,5	9,3	408
		0,75	1	415	2,2	79,4	0,61	2850	6,6	1,5	9,3	408
60 Hz	CORMOTOR 4" 1	0,75	1	380	2,3	79,4	0,72	3475	9,6	1,5	9,3	408
50 Hz	CORMOTOR 4" 1,5	1,1	1,5	380	3,1	73,4	0,73	2850	14,6	2,5	11,4	448
		1,1	1,5	400	3,2	73,4	0,68	2850	14,6	2,5	11,4	448
		1,1	1,5	415	3,4	73,4	0,63	2850	14,6	2,5	11,4	448
60 Hz	CORMOTOR 4" 1,5	1,1	1,5	380	3	73,4	0,77	3450	14,6	2,5	11,4	448
50 Hz	CORMOTOR 4" 2	1,5	2	380	4,5	75,4	0,67	2850	21,4	2,5	12	468
		1,5	2	400	4,7	75,4	0,62	2850	21,4	2,5	12	468
		1,5	2	415	4,9	75,4	0,58	2850	21,4	2,5	12	468
60 Hz	CORMOTOR 4" 2	1,5	2	380	3,8	75,4	0,81	3410	21,4	2,5	12	468
50 Hz	CORMOTOR 4" 3	2,2	3	380	5,5	77,2	0,79	2850	29,6	2,5	14,5	518
		2,2	3	400	5,7	77,2	0,72	2850	29,6	2,5	14,5	518
		2,2	3	415	5,1	77,2	0,66	2850	29,6	2,5	14,5	518
60 Hz	CORMOTOR 4" 3	2,2	3	380	5,3	77,2	0,79	3425	29,6	2,5	14,5	518
50 Hz	CORMOTOR 4" 4	3	4	380	7,4	78,3	0,78	2850	34,4	4,4	18,5	596
		3	4	400	7,6	78,3	0,73	2850	34,4	4,4	18,5	596
		3	4	415	7,9	78,3	0,68	2850	34,4	4,4	18,5	596
60 Hz	CORMOTOR 4" 4	3,7	5,5	380	7,3	78,3	0,80	3420	34,4	4,4	18,5	596
50 Hz	CORMOTOR 4" 5,5	4	5,5	380	10	78,3	0,78	2850	45	4,4	21,5	676
		4	5,5	400	10,3	78,3	0,72	2850	45	4,4	21,5	676
		4	5,5	415	10,9	78,3	0,66	2850	45	4,4	21,5	676
60 Hz	CORMOTOR 4" 5,5	3,7	5	380	9,1	78,3	0,84	3415	45	4,4	21,5	676
50 Hz	CORMOTOR 4" 7,5	5,5	7,5	380	13,8	78	0,77	2850	57,9	4,4	25,5	741
		5,5	7,5	400	14,6	78	0,70	2850	57,9	4,4	25,5	741
		5,5	7,5	415	15,4	78	0,65	2850	57,9	4,4	25,5	741
60 Hz	CORMOTOR 4" 7,5	5,5	7,5	380	12,3	78	0,85	3390	57,9	4,4	25,5	741
50 Hz	CORMOTOR 4" 10	7,5	10	380	18,3	78,7	0,79	2850	73,2	4,4	31,5	856
		7,5	10	400	18,7	78,7	0,74	2850	73,2	4,4	31,5	856
		7,5	10	415	19,6	78,7	0,69	2850	73,2	4,4	31,5	856
60 Hz	CORMOTOR 4" 10	7,5	10	380	18,2	78,7	0,79	3400	73,2	4,4	31,5	856

Motores trifásicos en baño de agua - Rebobinables 6" **CORMOTOR AQUA**
 6" three-phase motors in water bath-rewindable **CORMOTOR WATER**
 Moteurs triphasés dans bain d'eau rebobinables 6" **CORMOTOR AQUA**

Hz	Motor Tipo	Motor P2		Tensión (V)	I _n (A)	Rend. %	Cos. φ	RPM	I _{rr} A	Carga axial (KN)	Peso Kg	Long. (mm)
		kW	HP									
50 Hz	CORMOTOR AQUA 6" 10	7,5	10	380	17,2	79	0,84	2790	66,4	20	53	758
		7,5	10	400	16,5	80	0,82	2805	63,8	20	53	758
		7,5	10	415	16,1	80	0,81	2815	62,2	20	53	758
60 Hz	CORMOTOR AQUA 6" 10	7,5	10	460	14,2	78	0,85	3380	73	20	53	758
50 Hz	CORMOTOR AQUA 6" 12,5	9,2	12,5	380	20,8	81	0,84	2850	80,3	20	57	800
		9,2	12,5	400	20,2	81	0,82	2855	78,1	20	57	800
		9,2	12,5	415	19,5	82	0,81	2865	75,3	20	57	800
60 Hz	CORMOTOR AQUA 6" 12,5	9,2	12,5	460	17,4	79	0,85	3390	90	20	57	800
50 Hz	CORMOTOR AQUA 6" 15	11	15	380	23,7	82	0,86	2810	91,6	20	61	851
		11	15	400	22,8	83	0,84	2825	88	20	61	851
		11	15	415	22,2	83	0,83	2835	85,9	20	61	851
60 Hz	CORMOTOR AQUA 6" 15	11	15	460	19,6	81	0,87	3400	101	20	61	851
50 Hz	CORMOTOR AQUA 6" 17,5	13	17,5	380	28,7	81	0,85	2820	110,9	20	66	911
		13	17,5	400	27,6	82	0,83	2835	106,6	20	66	911
		13	17,5	415	26,6	83	0,82	2845	102,7	20	66	911
60 Hz	CORMOTOR AQUA 6" 17,5	13	17,5	460	23,4	81	0,86	3410	121	20	66	911
50 Hz	CORMOTOR AQUA 6" 20	15	20	380	33,1	81	0,85	2850	127,9	20	72	973
		15	20	400	32,2	81	0,83	2855	124,5	20	72	973
		15	20	415	31	82	0,82	2865	120	20	72	973
60 Hz	CORMOTOR AQUA 6" 20	15	20	460	27,3	80	0,86	3440	141	20	72	973
50 Hz	CORMOTOR AQUA 6" 25	18,5	25	380	41,8	81	0,83	2850	161,6	20	80	1006
		18,5	25	400	40,2	82	0,81	2865	155,4	20	80	1006
		18,5	25	415	38,8	83	0,80	2875	149,8	20	80	1006
60 Hz	CORMOTOR AQUA 6" 25	18,5	25	460	34,5	80	0,84	3450	178	20	80	1006
50 Hz	CORMOTOR AQUA 6" 30	22	30	380	48,5	82	0,84	2860	187,6	20	86	1106
		22	30	400	46,7	83	0,82	2875	180,3	20	86	1106
		22	30	415	45	84	0,81	2885	173,9	20	86	1106
60 Hz	CORMOTOR AQUA 6" 30	22	30	460	40,1	81	0,85	3460	207	20	86	1106
50 Hz	CORMOTOR AQUA 6" 35	26	35	380	56,4	84	0,85	2870	217,9	26,5	90	1217
		26	35	400	54,9	84	0,83	2885	212	26,5	90	1217
		26	35	415	52,9	85	0,82	2895	204,4	26,5	90	1217
60 Hz	CORMOTOR AQUA 6" 35	26	35	460	47,1	82	0,86	3470	242	26,5	90	1217
50 Hz	CORMOTOR AQUA 6" 40	30	40	380	64,6	83	0,85	2880	249,7	26,5	104	1247
		30	40	400	62,1	84	0,83	2895	240	26,5	104	1247
		30	40	415	59,9	85	0,82	2905	231,4	26,5	104	1247
60 Hz	CORMOTOR AQUA 6" 40	30	40	460	53,4	82	0,86	3480	272	26,5	104	1247
50 Hz	CORMOTOR AQUA 6" 50	37	50	380	81,6	83	0,85	2890	315,6	26,5	111	1347
		37	50	400	78,5	84	0,83	2905	303,3	26,5	111	1347
		37	50	415	74,7	84	0,82	2915	288,8	26,5	111	1347
60 Hz	CORMOTOR AQUA 6" 50	37	50	460	66,6	81	0,86	3490	341	26,5	111	1347
50 Hz	CORMOTOR AQUA 6" 60	45	60	380	92,1	81,8	0,85	2834	349,3	30	116	1275
		45	60	400	87,2	85	0,83	2834	335,5	30	116	1275
		45	60	415	83,6	85	0,82	2834	327,2	30	116	1275
60 Hz	CORMOTOR AQUA 6" 60	45	60	460	72	85,2	0,90	3424	382	30	116	1275

Motores trifásicos en baño de agua - Rebobinables 8" **CORMOTOR AQUA**
 8" three-phase motors in water bath-rewindable **CORMOTOR WATER**
 Moteurs triphasés dans bain d'eau rebobinables 8" **CORMOTOR AQUA**

Hz	Motor Tipo	Motor P2		Tensión (V)	I _n (A)	Rend. %	Cos. φ	RPM	I _{arr.} A	Carga axial (KN)	Peso Kg	Long. (mm)
		kW	HP									
50 Hz	CORMOTOR AQUA 8" 40	30	40	380	61,7	83	0,89	2850	238,5	45	127	1056
		30	40	400	59,3	84	0,87	2865	229	45	127	1056
		30	40	415	57,8	84	0,86	2875	223,3	45	127	1056
60 Hz	CORMOTOR AQUA 8" 40	30	40	460	51	82	0,90	3450	258	45	127	1056
50 Hz	CORMOTOR AQUA 8" 50	37	50	380	74,3	85	0,89	2860	287,2	45	133	1116
		37	50	400	71,4	86	0,87	2875	275,9	45	133	1116
		37	50	415	69,6	86	0,86	2885	269	45	133	1116
60 Hz	CORMOTOR AQUA 8" 50	37	50	460	61	84	0,90	3460	308	45	133	1116
50 Hz	CORMOTOR AQUA 8" 60	45	60	380	90,4	85	0,89	2860	349,3	45	140	1201
		45	60	400	86,8	86	0,87	2875	335,5	45	140	1201
		45	60	415	84,6	86	0,86	2885	327,2	45	140	1201
60 Hz	CORMOTOR AQUA 8" 60	45	60	460	75	84	0,90	3460	382	45	140	1201
50 Hz	CORMOTOR AQUA 8" 70	52	70	380	103,3	85	0,90	2850	399,2	45	146	1286
		52	70	400	99,2	86	0,88	2865	383,3	45	146	1286
		52	70	415	96,7	86	0,87	2875	373,7	45	146	1286
60 Hz	CORMOTOR AQUA 8" 70	52	70	460	85	84	0,91	3450	431	45	146	1286
50 Hz	CORMOTOR AQUA 8" 75	55	75	380	110,5	84	0,90	2850	427,2	45	152	1286
		55	75	400	107,4	84	0,88	2864	415,1	45	152	1286
		55	75	415	103,5	85	0,87	2876	399,9	45	152	1286
60 Hz	CORMOTOR AQUA 8" 75	55	75	460	90	84	0,91	3450	458	45	152	1286
50 Hz	CORMOTOR AQUA 8" 80	59	80	380	119,1	86	0,89	2850	460,3	45	160	1341
		59	80	400	115,7	86	0,87	2865	447,4	45	160	1341
		59	80	415	112,9	86	0,86	2875	436,2	45	160	1341
60 Hz	CORMOTOR AQUA 8" 80	59	80	460	100	84	0,90	3450	509	45	160	1341
50 Hz	CORMOTOR AQUA 8" 90	67	90	380	134,6	85	0,89	2850	520,1	45	169	1366
		67	90	400	129,3	86	0,87	2865	499,6	45	169	1366
		67	90	415	126	86	0,86	2875	487,1	45	169	1366
60 Hz	CORMOTOR AQUA 8" 90	67	90	460	111	84	0,90	3450	563	45	169	1366
50 Hz	CORMOTOR AQUA 8" 100	75	100	380	150,7	84	0,90	2850	582,6	45	190	1391
		75	100	400	144,7	85	0,88	2865	559,4	45	190	1391
		75	100	415	141,1	85	0,87	2875	545,3	45	190	1391
60 Hz	CORMOTOR AQUA 8" 100	75	100	460	123	84	0,91	3450	625	45	190	1391
50 Hz	CORMOTOR AQUA 8" 110	81	110	380	162,7	85	0,89	2855	628,8	55	197	1471
		81	110	400	156,3	86	0,87	2860	603,9	55	197	1471
		81	110	415	152,4	86	0,86	2865	588,9	55	197	1471
60 Hz	CORMOTOR AQUA 8" 110	81	110	460	134	84	0,90	3430	681	55	197	1471
50 Hz	CORMOTOR AQUA 8" 125	92	125	380	184,8	85	0,89	2820	714,1	55	208	1536
		92	125	400	177,5	86	0,87	2835	686	55	208	1536
		92	125	415	173,1	86	0,86	2850	668,9	55	208	1536
60 Hz	CORMOTOR AQUA 8" 125	92	125	460	153	84	0,90	3430	770	55	208	1536
50 Hz	CORMOTOR AQUA 8" 150	110	150	380	216	85,9	0,87	2852	835	45	295	1844
		110	150	400	209,7	86	0,87	2852	809	45	295	1844
		110	150	415	205	86	0,87	2852	791	45	295	1844
60 Hz	CORMOTOR AQUA 8" 150	110	150	460	185,1	89,2	0,82	3506	910	45	295	1844

Motores trifásicos en baño de agua - Rebobinables 10" **CORMOTOR AQUA**
10" three-phase motors in water bath-rewindable **CORMOTOR WATER**
Moteurs triphasés dans bain d'eau rebobinables 10" **CORMOTOR AQUA**

Hz	Motor Tipo	Motor P2		Tensión (V)	I _n (A)	Rend. %	Cos. φ	RPM	I _{arr.} A	Carga axial (KN)	Peso Kg	Long. (mm)
		kW	HP									
50 Hz	CORMOTOR AQUA 10" 110	81	110	380	159	84	0,79	2880	615	75	255	1370
		81	110	415	147	86	0,72	2905	569	75	255	1370
60 Hz	CORMOTOR AQUA 10" 110	81	110	460	131	84	0,92	3490	663	75	255	1370
50 Hz	CORMOTOR AQUA 10" 125	92	125	380	179	86	0,91	2890	690	75	274	1430
		92	125	415	169	86	0,88	2915	654	75	274	1430
60 Hz	CORMOTOR AQUA 10" 125	92	125	460	149	84	0,92	3500	748	75	274	1430
50 Hz	CORMOTOR AQUA 10" 150	110	150	380	216	86	0,96	2890	835	75	299	1510
		110	150	415	205	86	0,87	2915	791	75	299	1510
60 Hz	CORMOTOR AQUA 10" 150	110	150	460	180	84	0,91	3500	910	75	299	1510
50 Hz	CORMOTOR AQUA 10" 175	129	175	380	248	87	0,91	2910	957	75	328	1610
		129	175	415	232	88	0,88	2935	896	75	328	1610
60 Hz	CORMOTOR AQUA 10" 175	129	175	460	207	85	0,92	3510	1050	75	328	1610
50 Hz	CORMOTOR AQUA 10" 200	147	200	380	282	87	0,91	2900	1090	75	368	1740
		147	200	415	264	88	0,88	2925	1020	75	368	1740
60 Hz	CORMOTOR AQUA 10" 200	147	200	460	236	85	0,92	3500	1197	75	368	1740
50 Hz	CORMOTOR AQUA 10" 225	166	225	380	341,6	89	0,88	2908	1400	75	402	1922
60 Hz	CORMOTOR AQUA 10" 225	166	225	460	282,2	88	0,87	3504	1157	75	402	1922
50 Hz	CORMOTOR AQUA 10" 250	185	250	380	376,3	89	0,88	2915	1618	75	436	1922
60 Hz	CORMOTOR AQUA 10" 250	185	250	460	307,3	88	0,88	3509	1321	75	436	1922
50 Hz	CORMOTOR AQUA 10" 300	225	300	380	452,4	90	0,89	2922	1990	75	478	2040
60 Hz	CORMOTOR AQUA 10" 300	225	300	460	369,5	89	0,89	3514	1623	75	478	2040



ARRANQUE DIRECTO O AUTOTRANSFORMADOR • **DIRECT ON LINE STARTING** • DÉMARRAGE DIRECT OU AUTOTRANSFORMATEUR

U = 400 V Caída de tensión: 3% • **Line droppng: 3%** • $\cos \varphi = 0,85$ • Chutte de tensión: 3%

Temperatura ambiente: 30° C • **Ambient temperature: 30° C** • Temperature ambiante: 30° C

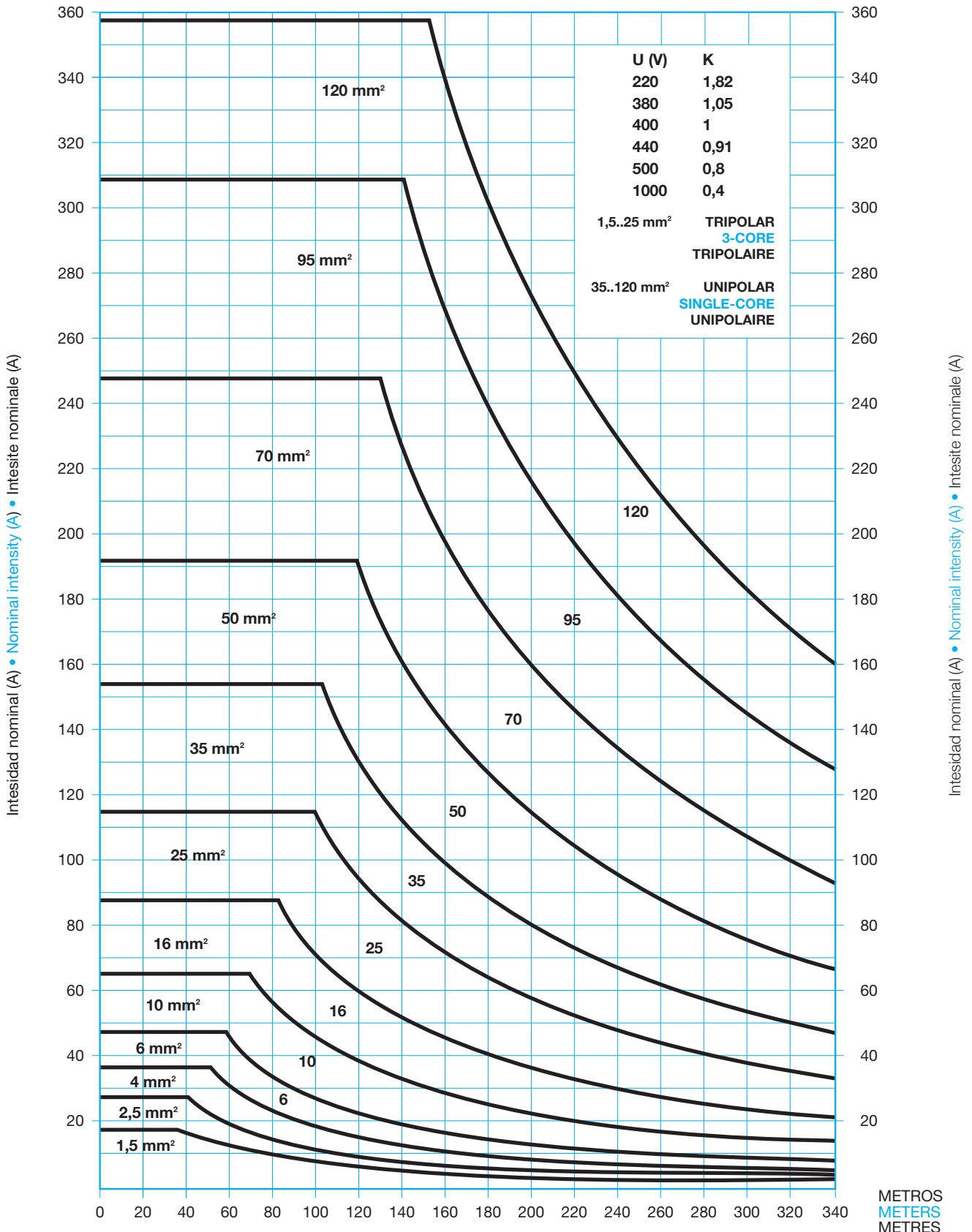

LONGITUD DE CADA CABLE • **LENGTH OF EVERY CABLE** • LONGEUR DE CHAQUE CABLE

Multiplicar la longitud del cable por K y entrar en la tabla en metros.

Multiply cable length by K and enter table through meters.

Multipler longueur du câble par K et entrer dans la table pour metres.

ARRANQUE ESTRELLA/TRIÁNGULO • STAR/DELTA STARTING • DÉMARRAGE ETOILE/TRIANGLE

U = 400 V Caida de tensión: 3% • Line dropping: 3% Cos $\varphi = 0,85$ • Chutte de tension: 3%

Temperatura ambiente: 30° C • Ambient temperature: 30° C • Temperature ambiante: 30° C

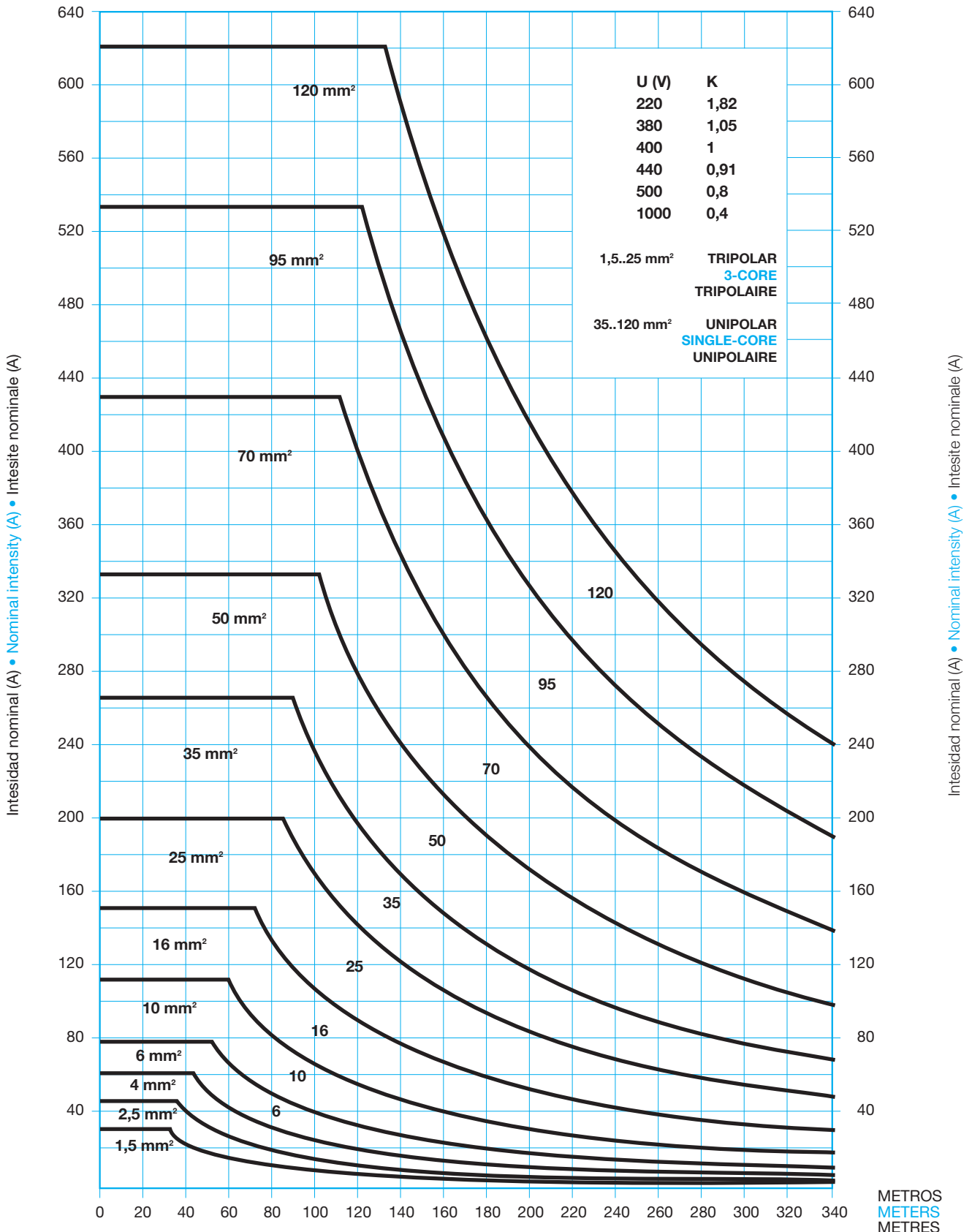

LONGITUD DE CADA CABLE • LENGTH OF EVERY CABLE • LONGEUR DE CHAQUE CABLE

Multiplicar la longitud del cable por K y entrar en la tabla en metros.

Multiply cable length by K and enter table through meters.

Multiplier longueur du câble par K et entrer dans la table pour metres.

Despiece motor rebobinable
Rewindable motors-spare parts list
Liste pieces detachees moteur immerge

DENOMINACIÓN PIEZAS NAME OF PARTS DENOMINATION PIECES	MATERIAL MATERIAL MATERIEL
1 STATOR / STATOR / STATOR	P.MAGNET + ACERO
1.1 BOBINADO / WINDING WIRE / BOBINAGE	Cu + PVC - P.P
1.2 NÚCLEO MAGNÉTICO / STATOR PACKAGE / NUCLE MAGNETIQUE	PLANCHA MAGNÉTICA / MAGNETIC SEAL / PLANCHE MAGNETIQUE
1.3 CAMISA STATOR / STATOR SHELL / STATOR CHEMISE	INOX AISI 304
2 ROTOR / ROTOR / ROTOR	P. MAGNET + Cu + ACERO / ACIER
2.1 CASQUILLO EJE / SHAFT SLEEVE / CHEMISE DU STATOR	St 37 (RECUBIERTAS CrNi / COATED CrNi / TRAITEMENT CrNi
2.2 ANILLO / BALANCE RING / ANNEAU	St 37
2.3 ANILLO CORTOCIRCUITO / COPPER RING / BAQUE DE COURT-CIRCUIT	Cu
3 COJINETE RADIAL / RADIAL BEARING / COUSSINET	GRAFITO / CARBON / GRAFITE
4 SOPORTE SUPERIOR / UPPER BEARING BODY / FLOSQUE SUPÉRIEUR	GG20-22
5 GUIA LABERINTO / BUSHING / BAGUE LABERINTE	BRONCE / BRONZE / BRONZE
6 SALVA ARENA / SLINGER (Sand Guard) / RONDELLE PARE SABLE	NBR_EPDM
7 TORNILLO SOPORTE SUPERIOR / HEXAGON SOCKET CAP SCREWS / VIS SUPPORT SUPÉRIEUR	INOX 304 - A - 2
8 ARANDELA / COPPER RING / RONDELLE	Cu
9 TAPA CIERRE / COVER SEAL / COUVERCLE GARNITURE MÉCANIQUE	INOX AISI 420
10 CIERRE MECÁNICO / MECHANICAL SEAL / GARNITURE MÉCANIQUE	CERÁMICA CARBONO / SERAMIC CARBON / CÉRAMIQUE CARBONE
11 CHAVETA / AXIAL THRUST BEARING KEY / CLAVETTE ACCOUPLEMENT	AISI 420
12 DISCO FRICCIÓN AXIAL / AXIAL THUST BEARING / DISQUE DE BUTÉE	GRAFITO / CARBON WITH ANTIMONY / GRAPHITE
13 ANILLO SEGGER / RETAINING RING / ANNEAU ELASTIQUE	St 37
14 TIRANTE / TIE ROD / TIRANTS D'ASSEMBLAGE	INOX 304 4 - 2
15 SOPORTE COJINETE INFERIOR / LOWER BEARING BODY / FLASQUE INFÉRIEUR	GG20-22
16 SOPORTE COJINETE AXIAL / THRUST BEARING SUPPORT / FLASQUE DISQUE DE BUTÉE	GG20-22
17 JAULA DE ESFERAS / BALL HOLDER / SUPPORT SPHÈRES	St 37 (RECUBIERTAS CrNi / COATED CrNi / TRAITEMENT CrNi
18 ESFERAS / THRUST BEARING BALL / SPHÈRES ROULEMENT	INOX
19 SEGMENTOS AXIAL / TILTING PADS / SEGMENTS	AISI 420
20 TORICO / O-RING / JOINT TORIQUE	NBR 70
21 CUERPO COJINETE AXIAL / THRUST BEARING BODY / CORPS DE PALIER AXIAL	GG20-22
22 ARANDELA / COPPER RING / RONDELLE	Cu
23 TUERCA / NUT / ECROU	INOX 304 - A - 2
24 TORNILLO (Regulación Axial) / SCREW (Thrust Bearing Base) / VIS	INOX 304 - A - 2
25 MEMBRANA / MEMBRANE / MEMBRANE	NBR-EPDM
26 BASE / MEMBRANE BODY / BASE	GG22
27 TORNILLO BASE / HEXAGON SOCKET CAP SCREWS / VIS	INOX - A - 2
28 VÁLVULA / CHECK-VALVE / CLAPET ANTIRRETOUR	BRONCE / BRONZE / BRONZE
29 TORICO / O-RING / JOINT TORIQUE	NBR 70
30 JUNTA CABLE / CABLE SEAL / JOINT	NBR
31 TAPA PRENSACABLE / SEAL COVER / DOUILLE ÉTANCHÉITE	AISI 304
32 TORNILLO TOMA TIERRA / NUT / VIS PRISE DE TERRE	INOX 304 - A - 2
33 TAPÓN VACIADOR (r 3/8") / PLUSH (r 3/8") / BOUCHON PURGE	BRONCE / BRONZE / BRONZE
34 FJADORES JAULA ESFERAS / BALL HOLDER PINS / PINS BALL PORTE FIXATION SUPPORT SPHÈRES	INOX

Despiece motor rebobinable
Rewindable motors-spare parts list
Liste pieces detachees moteur immerge

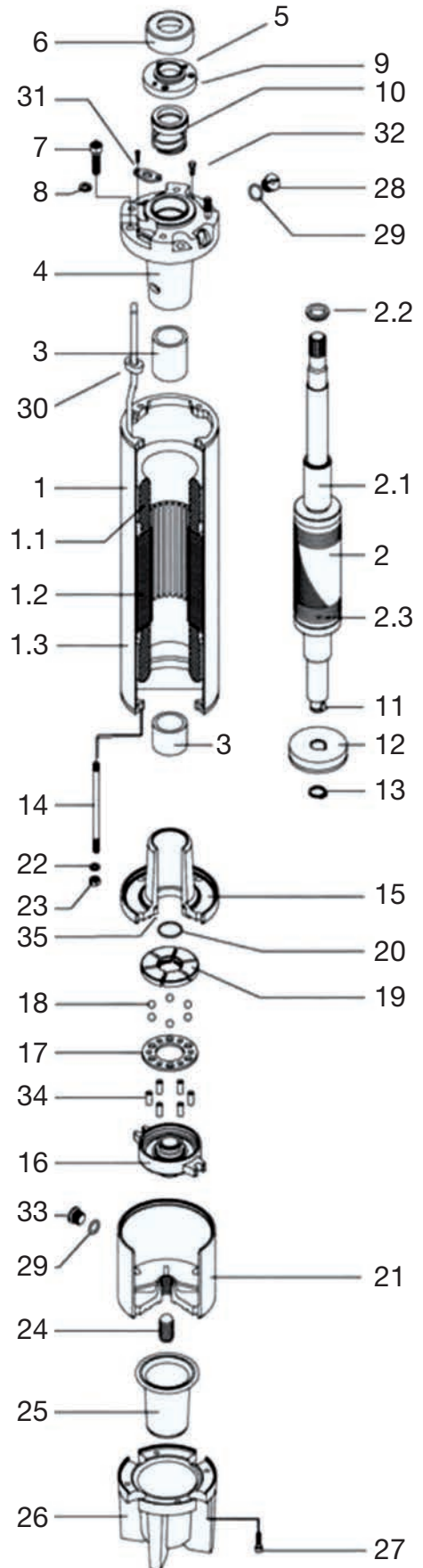
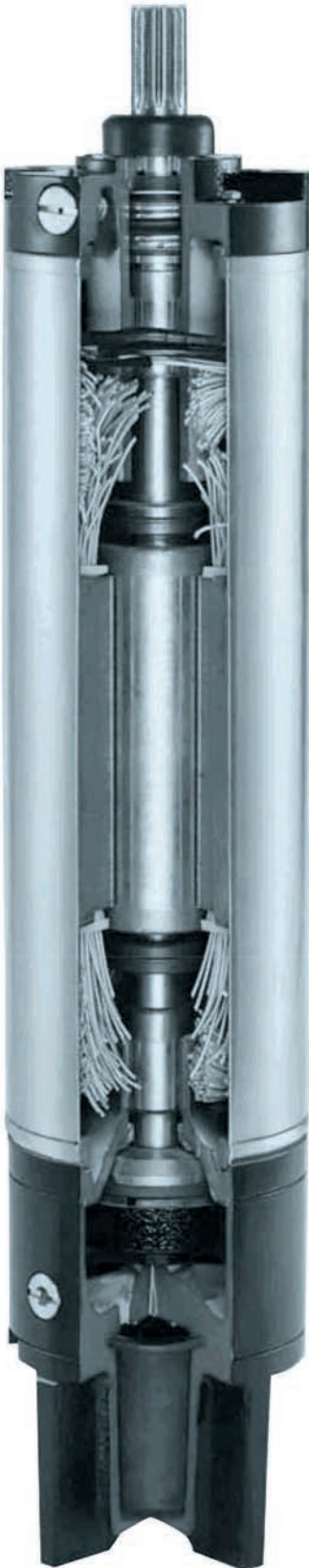

CORMOTOR

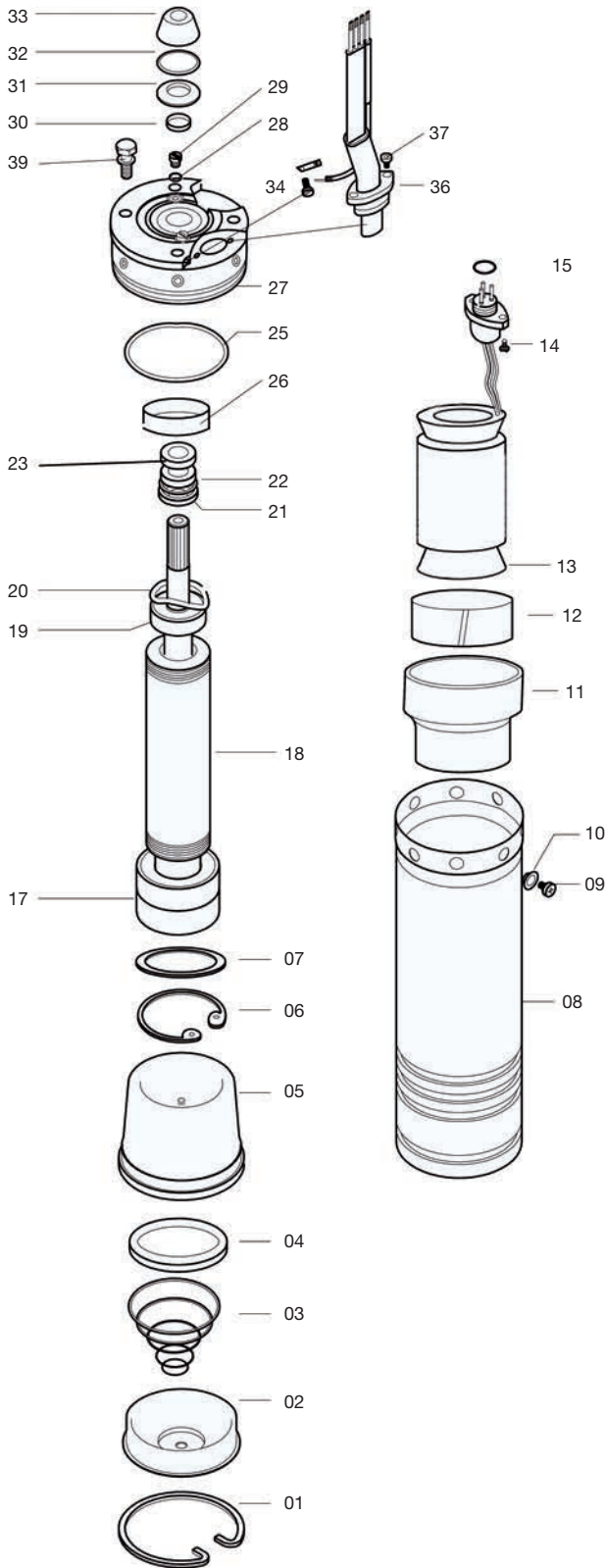

DENOMINACION PIEZAS
NAME OF PARTS
DENOMINATION PIECES

01	ANILLO ELASTICO ELASTIC RING ANNEAU ELASTIQUE	29	TAPON CAP BOUCHON
02	TAPA DIAFRAGMA DIAPHRAGM COVER COUVERCLE MEMBRANE	30	JUNTA RING JOINT
03	MUELLE SPRING RESORT	31	ARANDELA CIERRE ARENA SAND COVER RONDELLE PARE SABLE
04	ARANDELA WASHER RONDELLE	32	ARANDELA ANTIFRICCIÓN SAND COVER SHEET RONDELLE ANTIFRICTION
05	MEMBRANA DIAPHRAGM MEMBRANE	33	CIERRE DE ARENA SAND SEAL PARE-SABLE
06	ANILLO ELÁSTICO ELASTIC RING ANNEAU ELASTIQUE	34	TORNILLO TOMA DE TIERRA SCREW EARTH LABEL VIS PRISE DE TERRE
07	ESPACIADOR SPACER PIÈCE INTERCALAIRE	36	CONECTOR EXTERNO EXT. CONNECTOR CONECTEUR EXTERNE
08	CARCASA EXTERIOR OUTER CASE CARCASSE EXTERIEURE	37	TORNILLO SCREW VIS
09	TORNILLO SCREW VIS	38	ACEITE DIELECTRICO DIELECTRIC FLUID HUILE DIELECTRIQUE
10	ARANDELA WASHER RONDELLE	39	TORNILLO SCREW VIS
11	SOPORTE SUPERIOR LOWER SUPPORT FLASQUE INFÉRIEUR		
12	ANILLO AISLAMIENTO INSULATION PAPER ANNEAU ISOLEMENT		
13	ESTATOR STATOR STATOR		
14	TORNILLO WASHER VIS		
15	JUNTA TORICA O-RING JOINT TORIQUE		
17	RODAMIENTO BEARING ROULEMENT		
18	ROTOR ROTOR ROTOR		
19	RODAMIENTO BEARING ROULEMENT		
20	ARANDELA DE COMPENSACIÓN COMPENSATION WASHER RONDELLE DE COMPEMSATION		
21	JUNTA RING JOINT		
22	JUNTA RING JOINT		
23	CIERRE MECÁNICO MECHANICAL SEAL GARNITURE MÉCANIQUE		
25	JUNTA RING JOINT		
26	ARO DE PROTECCIÓN PROTECTION RING BAGUE DE PROTECTION		
27	SOPORTE SUPERIOR UPPER SUPPORT FLASQUE SUPÉRIEUR		
28	JUNTA RING JOINT		

SD 0,30

SD 0,36

SD 0,42

SD 0,46

SD 0,62

SD 0,76

SD 0,82

SD 0,88

SD 1,8 SDX 1,8

SD 2,5 SDX 2,5

SD 2,6 SDX 2,6

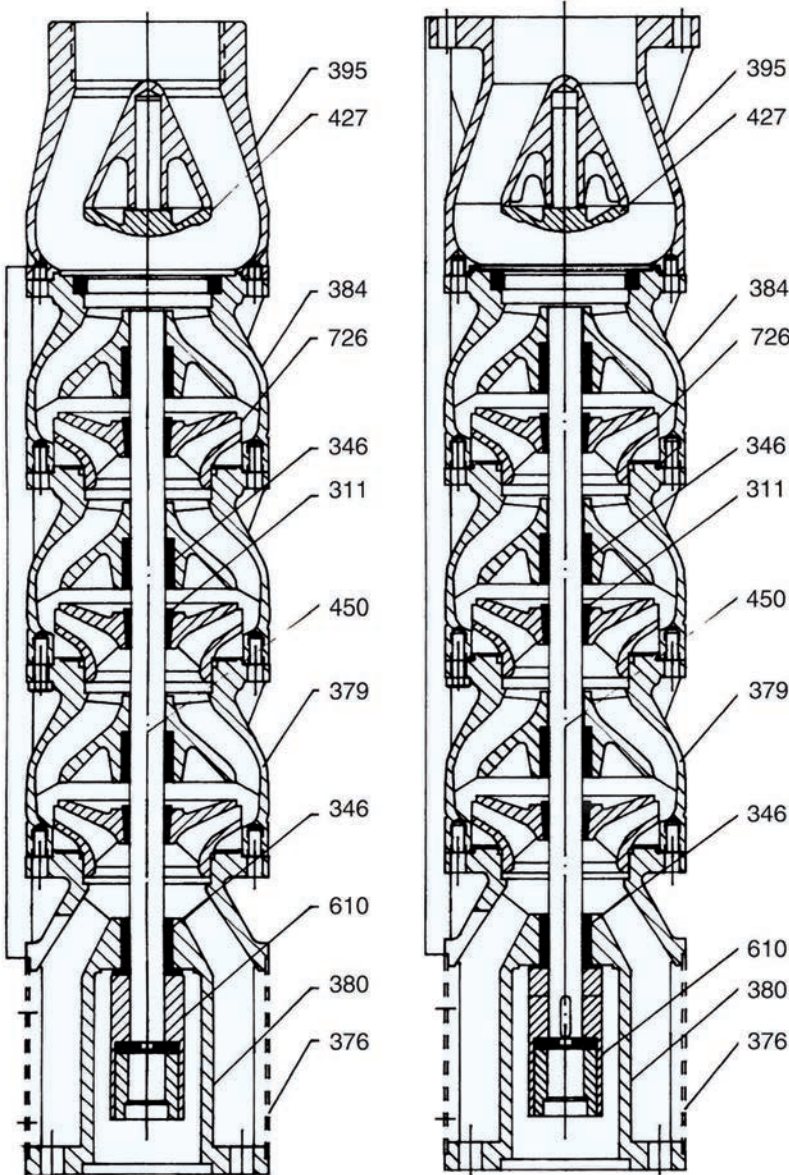

CÓDIGO CODE	DESIGNACIÓN DESIGNATION
311	BUJE RODETE CONIC BUSHING DOUILLE
346	COJINETE BEARING COUSSINET
376	COLADOR STRAINER CREPINE
379	DIFUSOR DIFFUSER DIFFUSEUR
380	CUERPO DE ASPIRACIÓN SUCTION CASING CORPS ASPIRATION
384	CUERPO BOMBA SUP. UPPER DIFFUSER DIFFUSEUR SUP.
395	CUERPO IMPULSIÓN DELIVERY CASING CORPS REFOULEMENT
427	VÁLVULA VALVE SOUPAPE
450	EJE BOMBA SHAFT ARBRE
485	JUNTA TÓRICA O'RING JOINT TORIQUE
610	MANGUITO COUPLING ACCOUPEMENT
726	RODETE IMPELLER TURBINE

**SD 1
SD 9**

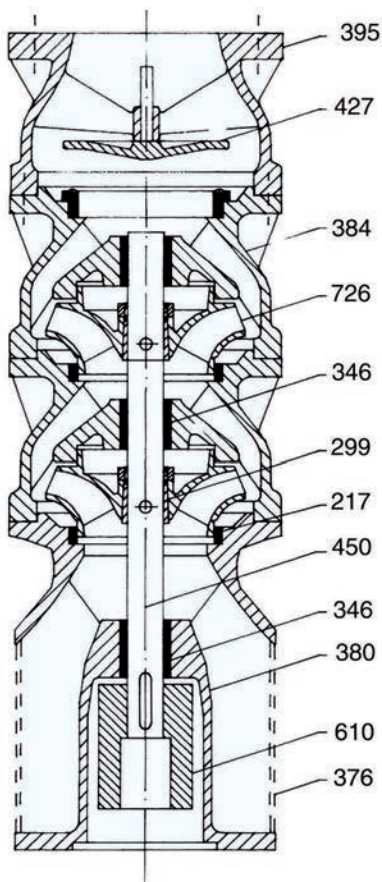

**SD 5
SD 6E**

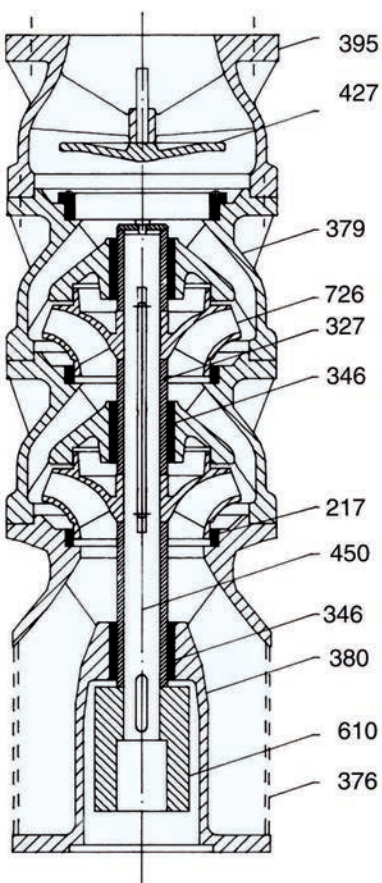

CODIGO CODE	DESIGNACIÓN DESIGNATION
217	ARO CIERRE WEAR RING BAGE D'USURE
299	BUJE RODETE LOCK COLLET MANCHON CENTRAGE
327	CASQUILLO INT. SPACER BUSH CHEMISE D'ARBRE
346	COJINETE BEARING COUSSINET
376	COLADOR STRAINER CREPINE
379	DIFUSOR DIFFUSER DIFFUSEUR
380	CUERPO ASPIRACIÓN SUCTION CASING CORPS ASPIRATION
395	CUERPO IMPULSIÓN DISCHARGING CASING CORPS REFOULEMENT
427	VÁLVULA VALVE SOUPAPE
450	EJE BOMBA SHAFT ARBRE
610	MANGUITO COUPLING ACCOUPEMENT
726	RODETE IMPELLER TURBINE

TXI 10

18

25

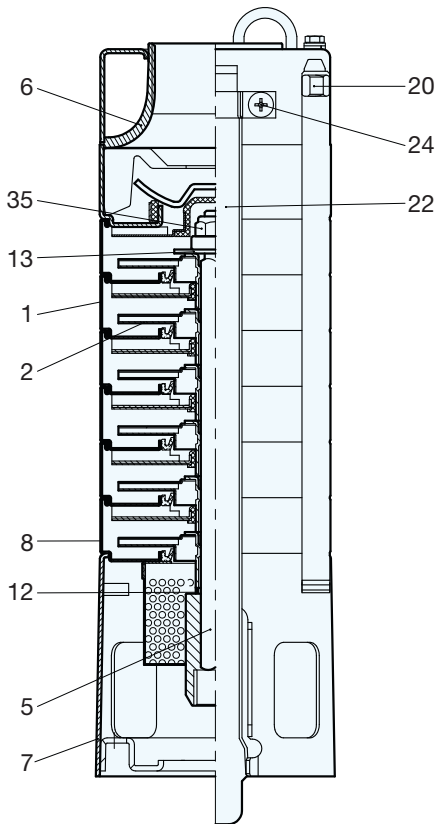

TXI 40

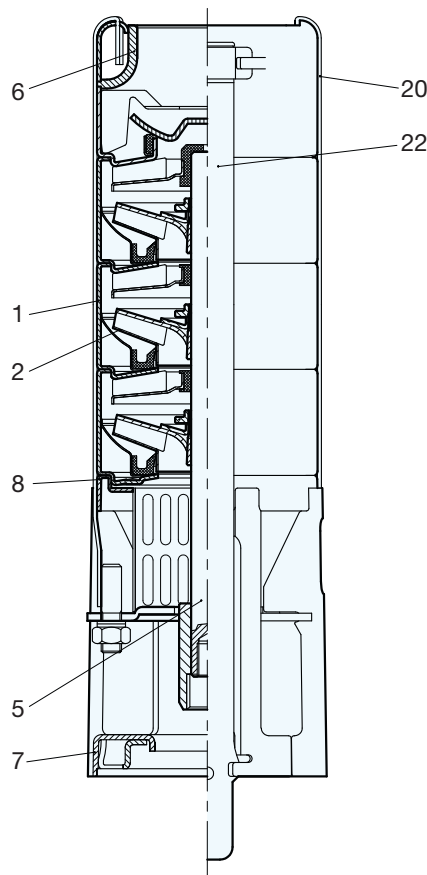

TXI 75

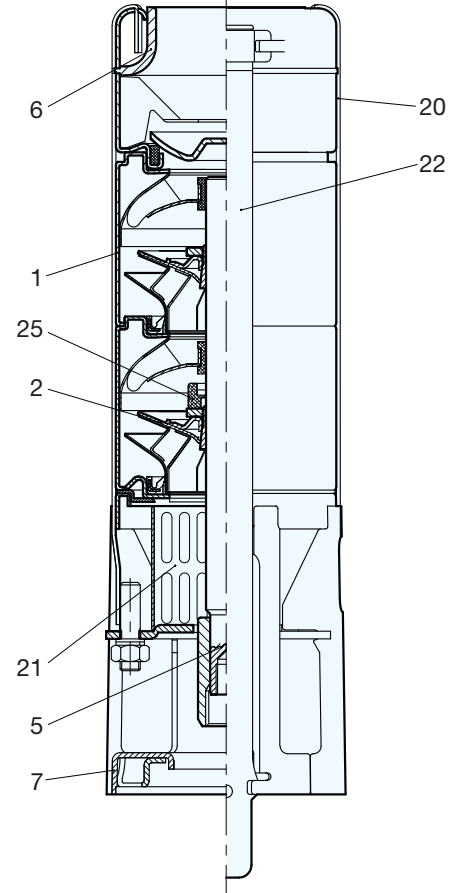

Nº	Descripción	Description	Description
* 1	Cuerpo intermedio con difusor	Intermediate chamber	Corps avec diffuseur
* 2	Rodete	Impeller assy	Roue
5	Eje de bomba y manguito	Pump shaft with coupling	Arbre avec accouplement
* 6	Cuerpo impulsión válvula	Discharge bowl	Corps refoulement
* 7	Cuerpo aspiración	Suction interconnector	Corps aspiration
* 8	Cuerpo colador	Lower chamber	Corps crépine
12	Espaciador	Spacer	Pièce intercalaire
13	Arandela	Washer	Rondelle
20	Tirantes sujeción	Tie bolt	Tirants d'assemblage
21	Colador	Stainer	Crépine
22	Protección cable	Supply cable guard	Protège câble
24	Tornillo	Screw	Vis
25	Disco axial	Up thrust disc	Disque de butée
35	Tuerca M8	Nut M8	Écrou M8

* Repuestos recomendados / [Recommended spare](#) / Pièces de rechange recommandées



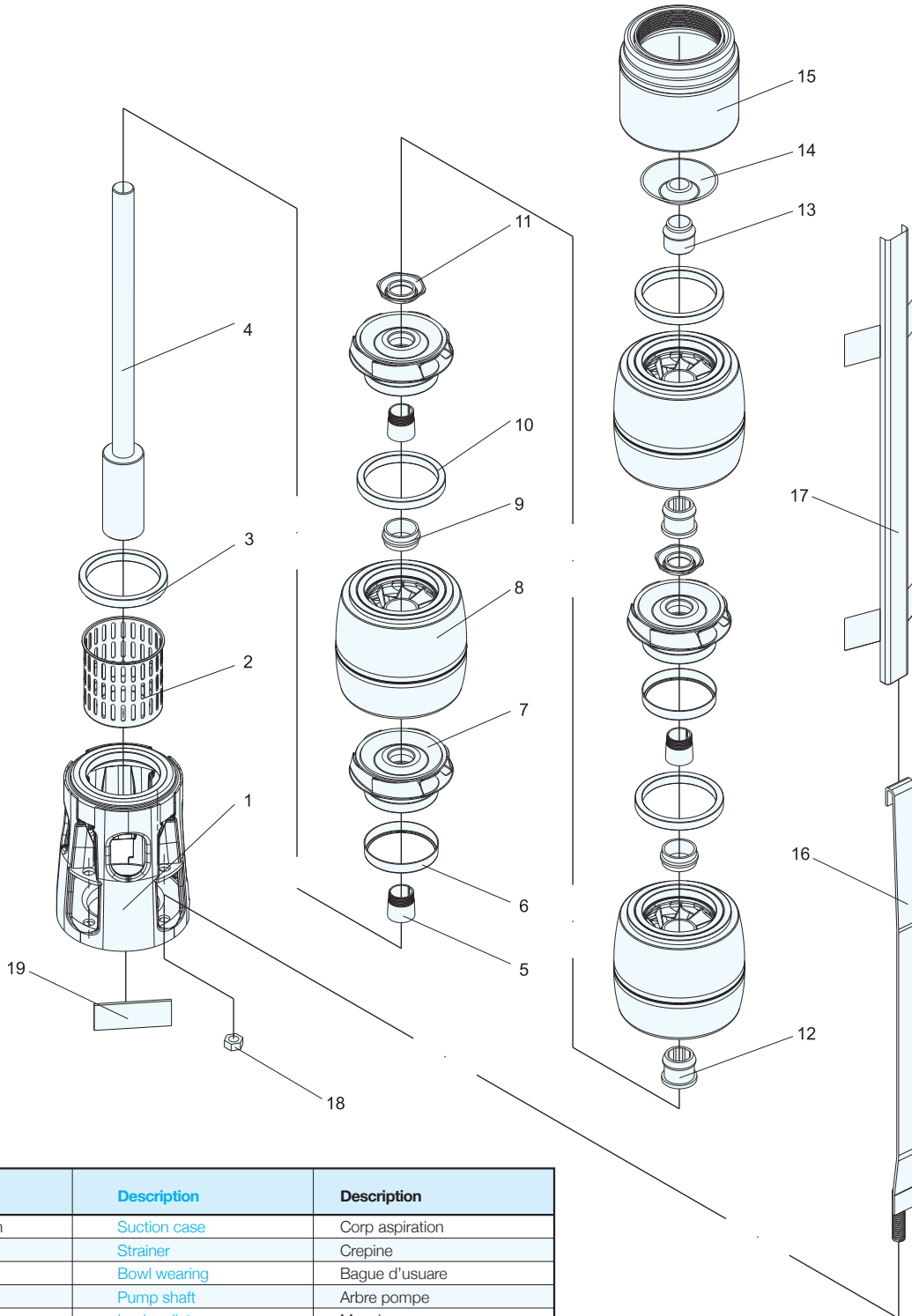

Descripción	Description	Description
Cuerpo aspiración	Suction case	Corp aspiration
Colador	Strainer	Crepine
Aro cierre	Bowl wearing	Bague d'usuare
Eje bomba	Pump shaft	Arbre pompe
Buje	Lock collet	Manchon
Aro cierre	Bowl wearing	Bague d'usuare
Rodete	Impeller	Roue
Difusor	Diffuser	Diffuseur
Cojinete goma	Rubber bearing	Coussinet caout
Aro cierre	Bowl wearing	Bague d'usuare
Tuerca buje	Lock collet nut	Ecrou douille
Cojinete difusor	Diffuser bearing bush	Palier intermediaire
Cojinete superior	Upper bearing bush	Palier supérieur
Válvula de retención	Valve	Clapet anti-retour
Cuerpo impulsión	Discharge case	Corp refoulement
Tirante sujeción	Tie bolt	Tirants d'assemblage
Cubre cable	Cable guard	Protège cable
Tuerca	Nut	Ecrou
Placa características	Name plate	Plaque de caractéristiques



Cuando no hay disponibilidad de corriente eléctrica por mediación de la red de distribución normal y la corriente es producida por un grupo electrógeno, éste debe de dar las potencias mínimas indicadas en la siguiente tabla.

When there aren't availability of electric current by mediation on the normaly distribution network and the power is producing by a power generating set, this debit to give minimum power indicated in the next table.

Lorsqu'il n'y à pas de disponibilité de courant électrique par l'intermédiaire du réseau de distribution normale et le courant est produit par un groupe électrogène, celui-ci doit indiquer les puissances minimum indiquées dans le tableau suivant.

Potencia grupo sumergido Power submersible group Puissance groupe immerge		Potencia mínima grupo electrógeno Minimum power generating set Puissance minime groupe electrogene
CV	KW	KVA
0,5	0,37	2
0,75	0,55	2,5
1	0,75	3
1,5	1,1	4,5
2	1,5	5
3	2,2	7,5
5	3,7	11
7,5	5,5	15
10	7,5	18
15	11	27
20	15	36
25	18,5	45
30	22	55
35	26	65
40	30	75
50	37	90
60	45	110
70	52	130
80	59	150
90	67	165
100	74	185
125	92	230
150	111	260



Armarios de arranque y protección para motores trifásicos

Arraque directo, estrella, triangulo o reactancia constituidos por:

- Armario estanco
- Interruptor general
- Arrancador tripolar
- Relé térmico
- Pulsadores marcha y paro
- Conmutador automático-manual
- Voltímetro/amperímetro
- Conmutador Aut-o-Man

Elementos adicionales

- Relé de nivel, como protección contra la marcha en seco. Permite el funcionamiento automático entre dos niveles en paro o depósito
- Temporizador retardador de arranque
- Relé diferencial
- Relé protección tensión baja, inversión o fallo de fase

Para otras protecciones no especificadas, consultar

Starting and protection switchboards for three phase motors

Direct starting, star-delta or reactance consisting of:

- Tight cupboard
- General switch
- Three core starter
- Thermal relay
- Start/stop pushbuttons
- Automatic-manual switch
- Voltmeter/Ammeter
- Aut-o-Man switch

Optional elements

- Level relay to avoid the group to run dry. It lets the group to run automatically between two levels
- Starting retarder timer
- Differential relay
- Low voltage protective relay, inversion or phase failure

Other protections on request

Armoires de commande et protection pour moteurs triphasés

Démarrages direct, étoile triangle ou reactance constitués par:

- Armoire étanche
- Interrupteur général
- Démarreur tripolaire
- Relais thermique
- Poussoirs marche et arrêt
- Commutateur automatique-manuel
- Voltimètre/amperimètre
- Commutateur Aut-o-Man

Elements optionnelles

- Relais de niveau comme protection contre la marche en sec qui permet le fonctionnement automatique entre deux niveaux du puits ou dépôt
- Temporisateur retardateur de démarrage
- Relais différentiel
- Relais de protection contre la tension basse, inversion ou manque de phase

Pour autres protection non indiquées, consulter



Tubería, placa y accesorios Pipe, plate and accessories Tuyauterie, plaque et accessoires		
Ø mm.	Ø" inches	ψ mm.
50	2	300
70	2 1/2	
80	3	350
100	4	400
125	5	450
150	6	
175	7	500
200	8	
250	10	

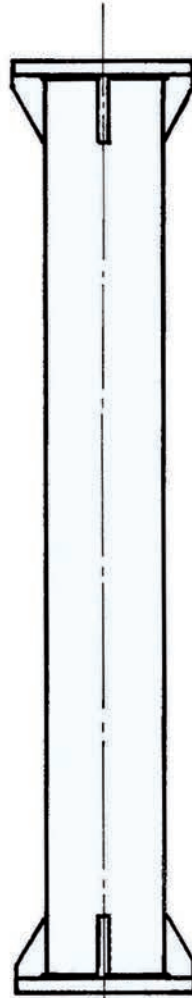

TUBOS COLUMNA, 3 O 6 M. LONGITUD
COLUMN PIPES, 3 OR 6 M. LENGTH
TUBES COLONNE, 3 OU 6 M. LONGUEUR

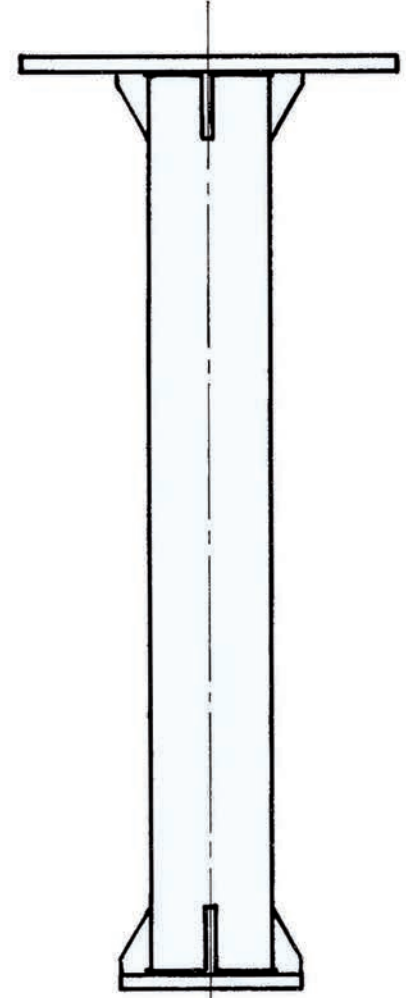

TUBOS CON PLACA
PIPES WITH PLATE
TUBES AVEC PLAQUE

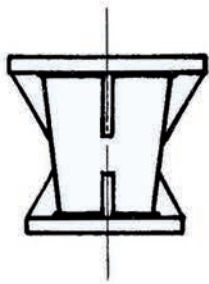

CONOS UNION BOMBA
PUMP CONE ADAPTORS
CONES UNION POMPE

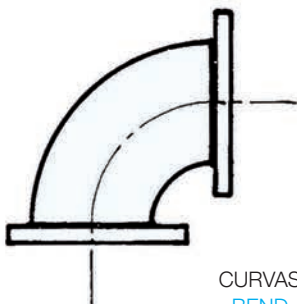

CURVAS
BEND
COURBES

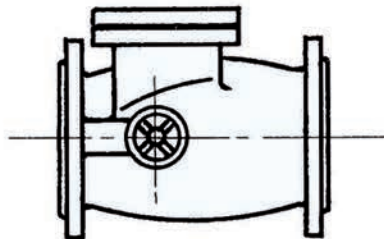

VALVULA DE RETENCION
NON RETURN VALVE
CLAPET DE RETENUE

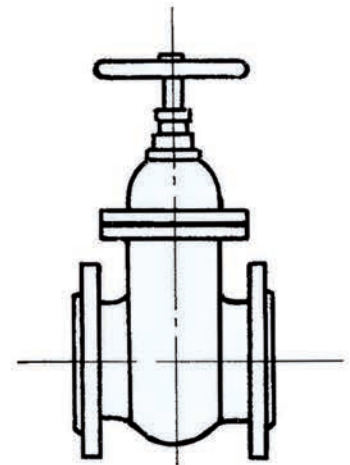

VALVULA REGULADORA
CHECK VALVE
VANNE REGULATION

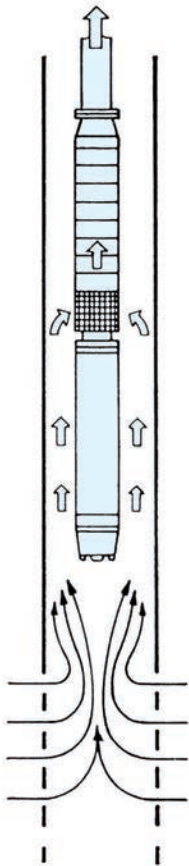

La refrigeración en los motores sumergidos está confiada al mismo líquido extraído por la bomba, el cual al pasar alrededor del motor actúa de fluido refrigerante. La capacidad de refrigeración depende de la velocidad de dicho fluido y de su temperatura, notablemente inferior a la que se pudiera alcanzar en el interior del motor. Las velocidades mínimas de circulación varían entre 8 cm/sg para motores de 4" y 16 cm/sg para el resto de los motores.

The cooling of the submerged motors is guaranteed by the liquid drawn up by the pump, which, acts as a coolant fluid as circulates around the pump. The rate of the cooling depends on the speed and temperature of this, being notably inferior to that capable of being reached in the inside of the motor. The minimum circulation speeds vary between 8 cm/sg for 4" motors and 16 cm/sg for the rest.

La refrigeration dans les moteurs est assurée par le liquide pompé, lequel à son passage autour du moteur agit comme fluide réfrigérant. La capacité de réfrigération dépend de la vitesse de ce fluide et de sa température, sensiblement inférieure à celle atteinte à l'intérieur du moteur. Les vitesses minimales de circulation varient entre 8 cm/sg pour moteurs de 4" y 16 cm/sg pour les autres moteurs.

CAUDAL MINIMO NECESARIO EN L/MIN. PARA LA REFRIGERACION DEL MOTOR
 MINIMUM DELIVERY NECESSARY IN L/MIN. FOR THE COOLING OF THE MOTOR
 DEBIT MINIMUM NECESSAIRE EN L/MIN. POR LA REFRIGERATION DU MOTEUR

Ø Motor Ø Moteur	Ø Perforación / Ø Perforation					
	6"	8"	10"	12"	14"	16"
4"	50	115	200	300	425	565
6"	-	140	300	525	765	1050
8"	-	-	190	400	645	925
10"	-	-	-	260	500	785
12"	-	-	-	-	350	630

Uso de la camisa de refrigeración

El motor sumergido que no tenga asegurada la velocidad mínima de flujo de agua alrededor del motor necesita el uso de una camisa de refrigeración.

Ejemplos donde la camisa de refrigeración es necesaria:

- Bombeo en un lago, embalse o depósito.
- Pozo o perforación de diámetro mayor del requerido.
- Pozo o perforación con aportación por encima del colador de la bomba.
- Grupo sumergido trabajando en horizontal.

Para los casos en que se precise un control adicional sobre la temperatura del motor es posible la incorporación de sondas PTC o PT-100 en el bobinado.

Use of suction shrouds

Submersible pump motors require a minimum flow velocity across the motor casing to ensure adequate cooling. Where this minimum flow cannot be guaranteed, a suction shroud is necessary.

Examples of where a suction shroud could be required include:

- Submersible pumps installed in lakes or reservoir.
- Large diameter boreholes or wells.
- Where the pump is installed below the well inlet screen.
- Where the pump is installed horizontally.

If additional motor protection is required, PT-100 or PTC temperature detectors can be fitted in the stator windings.

Utilisation de chemise de refroidissement

Le moteur immergé, n'ayant pas une vitesse minimum de flux assurée d'eau autour du moteur, doit être équipé d'une chemise de refroidissement.

Exemples où la chemise est nécessaire:

- Pompage dans une barrage, lac ou reservoir.
- Des forages d'un diamètre supérieur à celui requis.
- Des forages avec apport d'eau au dessus de la pompe.
- Groupe immergé en horizontal.

Pour les cas où serait nécessaire un contrôle sur la température du moteur, il est possible d'incorporer des sondes PTC ou PT-100 dans le bobinage.

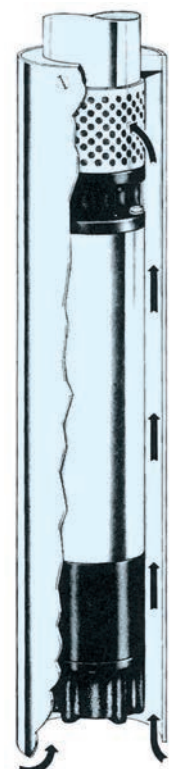

Conexión del cable de alimentación

La sección del cable a empalmar se elegirá según la intensidad que va a transportar, la tensión de alimentación y la longitud de cada tramo.

Conexión en monofásicos. Es preciso respetar las polaridades del motor para que en el extremo libre del cable distingamos la fase común, la auxiliar y la principal.

Conexión en trifásicos. La conexión adecuada en el motor según la tensión de red, características del arranque y bobinado del motor, viene indicada en la siguiente tabla:

Feeding cable connection

The cable section to be fitted will be selected according to the intensity, line voltage and length of each outlet.

Singlephase connection. It is necessary to respect the motor polarities, in order to enable us to distinguish in the free end cable, the common, the auxiliary and the main phases.

Threephase connection. The right connection in the motor according to the line voltage, starting type and motor winding, is indicated on the following table:

Connexion du cable d'alimentation

On choisira la section du câble à relier selon l'intensité qu'il va transporter, la tension d'alimentation et sa longueur.

Connexion en monophasés. Il faut respecter les polarités du moteur pour que l'on puisse distinguer la phase commune, l'auxiliaire et la principale à l'extrémité libre du câble.

Connexion en triphasés: La connexion des câbles de sortie du moteur selon la tension du réseau, les caractéristiques du démarrage et du bobinage du moteur et indiquée dans le tableau ci-dessous:

Red Line voltage Tension reseau	Arranque Starting Demarrage	Motor - Moteur	
		Bobinado Winding Bobinage	Conexión Connection Connexion
230 V.	Directo o reactancia Direct of reactance Direct ou reactance	230/400	Triángulo Delta Triangle
	Estrella triángulo Star delta Etoile triangle	230/400	Estrella - Triángulo Star - Delta Etoile - Triangle
400 V.	Directo o reactancia Direct of reactance Direct ou reactance	230/400	Estrella Star Etoile
		400/690	Triángulo Delta Triangle
	Estrella triángulo Star delta Etoile triangle	400/690	Estrella - Triángulo Star - Delta Etoile - Triangle

CONEXION PARA TRIANGULO • DELTA CONNECTION • CONNEXION TRIANGLE

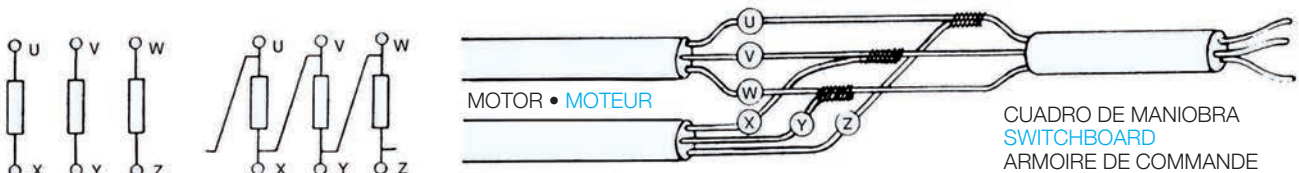

CONEXION PARA ESTRELLA • STAR CONNECTION • CONNEXION ETOILE

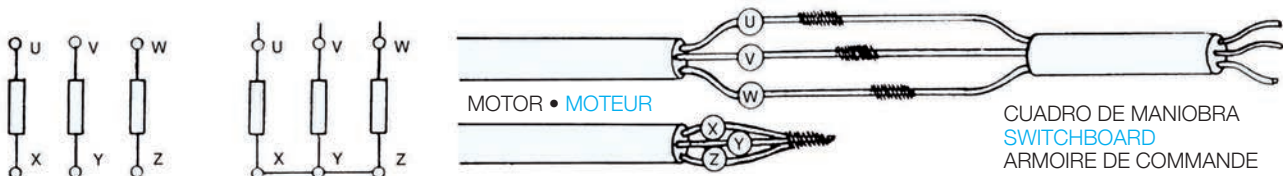

CONEXION PARA ESTRELLA-TRIANGULO • STAR DELTA CONNECTION • CONNEXION POUR ETOILE-TRIANGLE

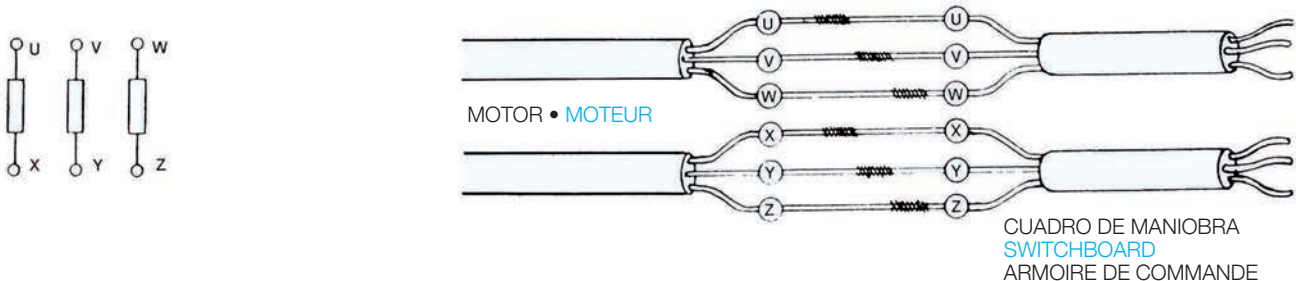

bombas
IDEAL



**Inoxidable
microfusión
AISI 304-316**

***AISI 304-316
Invest castig***





BOMBAS IDEAL, S.A. se reserva el derecho de variar datos y dimensiones de este catálogo sin previo aviso.
BOMBAS IDEAL, S.A. reserved the right to alter performance, specifications at any time without prior notice.
BOMBAS IDEAL, S.A. se reserve le droit de varier les renseignements et dimensions de ce catalogue sans préavis.

BOMBAS IDEAL, S.A.

Polígono Industrial Mediterráneo. Calle Cid, 8
Tel.: 34 961 402 143 - 902 203 400 - FAX: 34 96 140 21 31
Massalfassar - Valencia (Spain)
www.bombasideal.com

